



ROYAL CANADIAN AIR CADETS

PROFICIENCY LEVEL FIVE INSTRUCTIONAL GUIDES

(ENGLISH)

(Supersedes A-CR-CCP-805/PF-001 dated 2010-10-01)

Cette publication est disponible en français sous le numéro A-CR-CCP-805/PF-002.

Issued on Authority of the Chief of the Defence Staff

Canada



NOTICE

This documentation has been reviewed by the technical authority and does not contain controlled goods. Disclosure notices and handling instructions originally received with the document shall continue to apply.

AVIS

Cette documentation a été révisée par l'autorité technique et ne contient pas de marchandises contrôlées. Les avis de divulgation et les instructions de manutention reçues originalement doivent continuer de s'appliquer.



ROYAL CANADIAN AIR CADETS

PROFICIENCY LEVEL FIVE INSTRUCTIONAL GUIDES

(ENGLISH)

(Supersedes A-CR-CCP-805/PF-001 dated 2010-10-01)

Cette publication est disponible en français sous le numéro A-CR-CCP-805/PF-002.

Issued on Authority of the Chief of the Defence Staff

OPI: D Cdts 3 – Senior Staff Officer Youth Programs Development

2015-07-01

Canada



NOTICE

This documentation has been reviewed by the technical authority and does not contain controlled goods. Disclosure notices and handling instructions originally received with the document shall continue to apply.

AVIS

Cette documentation a été révisée par l'autorité technique et ne contient pas de marchandises contrôlées. Les avis de divulgation et les instructions de manutention reçues originalement doivent continuer de s'appliquer.

LIST OF EFFECTIVE PAGES

Insert latest changed pages and dispose of superseded pages in accordance with applicable orders.

NOTE

The portion of the text affected by the latest change is indicated by a black vertical line in the margin of the page. Changes to illustrations are indicated by miniature pointing hands or black vertical lines.

Dates of issue for original and changed pages are:

Original.....	0	2015-07-01	Ch.....	3
Ch.....	1		Ch.....	4
Ch.....	2		Ch.....	5

Zero in Change No. column indicates an original page. Total number of pages in this publication is 569 consisting of the following:

Page No.	Change No.	Page No.	Change No.
Cover page.....	0	M503.02D-1 to M503.02D-6.....	0
Title.....	0	M503.03-1 to M503.03-14.....	0
A to C.....	0	M503.04-1 to M503.04-6.....	0
i to x.....	0	M503.04A-1 to M503.04A-2.....	0
C501.01-1 to C501.01-4.....	0	C503.01-1 to C503.01-6.....	0
C501.01A-1 to C501.01A-20.....	0	C503.01A-1 to C503.01A-20.....	0
C501.02-1 to C501.02-4.....	0	C503.01B-1 to C503.01B-2.....	0
C501.02A-1 to C501.02A-14.....	0	C503.01C-1 to C503.01C-8.....	0
C501.03-1 to C501.03-4.....	0	M504.01-1 to M504.01-6.....	0
C501.03A-1 to C501.03A-8.....	0	M504.01A-1 to M504.01A-2.....	0
C501.03A1-1 to C501.03A1-6.....	0	M504.01B-1 to M504.01B-2.....	0
C501.03A2-1 to C501.03A2-6.....	0	C504.01-1 to C504.01-4.....	0
C501.03A3-1 to C501.03A3-8.....	0	C504.01A-1 to C504.01A-26.....	0
C501.03A4-1 to C501.03A4-8.....	0	C504.01A1-1 to C504.01A1-4.....	0
M502.01-1 to M502.01-12.....	0	C504.01A2-1 to C504.01A2-4.....	0
M502.01A-1 to M502.01A-2.....	0	C504.01B-1 to C504.01B-2.....	0
M502.01B-1 to M502.01B-2.....	0	M507.01-1 to M507.01-16.....	0
M502.01C-1 to M502.01C-2.....	0	M507.01A-1 to M507.01A-2.....	0
M502.01D-1 to M502.01D-2.....	0	C507.01-1 to C507.01-4.....	0
M502.01E-1 to M502.01E-2.....	0	C507.01A-1 to C507.01A-22.....	0
M503.01-1 to M503.01-10.....	0	C507.01B-1 to C507.01B-4.....	0
M503.01A-1 to M503.01A-2.....	0	C507.02-1 to C507.02-4.....	0
M503.01B-1 to M503.01B-2.....	0	C507.02A-1 to C507.02A-14.....	0
M503.02-1 to M503.02-20.....	0	C507.02B-1 to C507.02B-4.....	0
M503.02A-1 to M503.02A-2.....	0	C507.02C-1 to C507.02C-2.....	0
M503.02B-1 to M503.02B-8.....	0	C507.03-1 to C507.03-4.....	0
M503.02C-1 to M503.02C-4.....	0	C507.03A-1 to C507.03A-20.....	0

LIST OF EFFECTIVE PAGES (Cont)

Page No.	Change No.	Page No.	Change No.
C509.01-1 to C509.01-4.....	0	C560.01B-1 to C560.01B-4.....	0
C509.01A-1 to C509.01A-14.....	0	C560.02-1 to C560.02-4.....	0
C509.01B-1 to C509.01B-2.....	0	C560.02A-1 to C560.02A-26.....	0
C509.01C-1 to C509.01C-2.....	0	C560.02B-1 to C560.02B-8.....	0
C509.01D-1 to C509.01D-4.....	0	C570.01-1 to C570.01-4.....	0
C530.01-1 to C530.01-4.....	0	C570.01A-1 to C570.01A-26.....	0
C530.01A-1 to C530.01A-10.....	0	C570.01B-1 to C570.01B-4.....	0
C540.01-1 to C540.01-4.....	0	C590.01-1 to C590.01-4.....	0
C540.01A-1 to C540.01A-20.....	0	C590.01A-1 to C590.01A-20.....	0
C540.01B-1 to C540.01B-2.....	0	C590.01B-1 to C590.01B-2.....	0
C560.01-1 to C560.01-4.....	0		
C560.01A-1 to C560.01A-20.....	0		

Contact Officer: D Cdts 3-2-6 – Air Cadet Program Development Staff Officer

© 2015 DND/MDN Canada

THIS PAGE INTENTIONALLY LEFT BLANK

FOREWORD AND PREFACE

1. **Issuing Authority.** This Instructional Guide (IG) A-CR-CCP-805/PF-001 was developed under the authority of the Director Cadets and Junior Canadian Rangers, and issued on the authority of the Chief of Defence Staff.
2. **Development.** Development of this IG was in accordance with the performance oriented concept of training outlined in the A-P9-050 Series, *Canadian Forces Individual Training and Education System*, with modifications to meet the needs of the Cadet Organization.
3. **Purpose of the IG.** The IG to be used by Royal Canadian Air Cadet Squadrons in conjunction with other resources to conduct Proficiency Level Five. The IG provides instructors with the base means from which to deliver training. Individual IGs are to be reviewed in conjunction with the Lesson Specifications (LSs) found in Chapter 4 of A-CR-CCP-805/PG-001, *Royal Canadian Air Cadets Proficiency Level Five Qualification Standard and Plan*, before instructing, so that each instructor can adequately plan for and prepare each lesson. Instructors may be required to develop instructional materials to support training in addition to any that may be provided, eg, posters, videos, handouts, models, etc, supplemental to training control and support documents. Suggested instructional activities are included in most IGs to maximize learning and fun. Instructors are also encouraged to modify and / or enhance the activities, as long as they continue to contribute to enabling objective achievement.
4. **Use of the IG.** Throughout these IGs, a series of information boxes are used to highlight information; they include:



Note to the Instructor.



Key information to pass along to cadets.



Refer to the following CF regulations and policies.



Points of interest or special instructions the instructor should pass along to cadets.



Introduce the material to be presented in the section.



Personal question to which a written answer is expected.



Did you know?

Information meant to add to the interest level of self study packages.



Activate Your Brain

Confirmation question to which a written answer is expected.

An answer key is provided at the end of each self-study package.



Instructions on where to get more information on the subject.



Rhetorical question meant for reflection. A written answer is not expected.



Question that refers to previously taught mandatory material. A written answer is expected.



Information to explain or clarify the content of a self-study package.



Indication of the end of the content within a self study package. If applicable a final exercise will follow which the cadet will complete and return to the Proficiency Level / Training Officer.

5. **Suggested Changes.** Suggested changes to this document shall be forwarded through the normal chain of command to National Defence Headquarters (NDHQ) Attention: Air Cadet Program Development Staff Officer (D Cdts 3-2-6), or by email to cadettraining@canada.ca.

ADDITIONAL REFERENCES USED DURING DEVELOPMENT EO M504.01

EO M504.01

About.com (2013). *Corpse pose – yoga poses*. Retrieved from: <http://yoga.about.com/od/yogaposes/a/savasana.htm>

About.com. (2013). *Step by step – cardio exercises for home workouts*. Retrieved from: <http://exercise.about.com>

About.com (2013). *Yoga poses*. Retrieved from:<http://yoga.about.com/od/yogaposes/a/childspose.htm>

Answers Corporation. (2013). *Curl up*. Retrieved from: <http://www.answers.com/topic/curl-up>

Beth Israel Deaconess Hospital-Milton. (2012). *Best shoveling tips from BID-Milton rehabilitation services*. Retrieved from: <http://www.miltonhospital.org/images/stretch2.jpg>

Blogger. (2012). *#55 – Jumping Jack Flash*. Retrieved from: <http://4.bp.blogspot.com/-B8uBAc3uoC8/Tw4rJWuAMAI/AAAAAAAAAC8I/bZcwxuQvQ6Q/s1600/jumping+jack.jpg>

Competitor Group Inc. (2013) *Five Technique Drills For Better Running*. Retrieved from: http://triathlon.competitor.com/2010/09/training/five-technique-drills-for-better-running_12964/attachment/buttknicks

Corbin, C., & Lindsey, R. (2007). *Fitness for life: Updated fifth edition*. Windsor, ON: Human Kinetics.

Covey, Stephen (2004). *The 7 Habits of Highly Effective People*. Free Press.

Exercise.com. (2013). *Leg sloop*. Retrieved from: http://d3vs5ss8iow0ry.cloudfront.net/video-library/thumbnail/leg-sloop_-_step_1.max.v1.png

Farmers of Canada. (2013) *What's in an egg?* Retrieved from: <http://www.eggs.ca/egg-nutrition/whats-in-an-egg>

Finger Lakes Fitness Center. (2011). *Perform the Perfect Push up*. Retrieved from: <http://fingerlakesfitness.com>

Fitness Perks LLC. (2012). *Focus on donkey kicks*. Retrieved from: <http://www.pbfingers.com/wp-content/uploads/2012/02/donkey-kicks.jpg>

Health Canada. (2011). *Eating well with Canada's food guide*. Retrieved from http://www.hc-sc.gc.ca/fn-an/alt_formats/hpfb-dgpsa/pdf/food-guide-aliment/print_eatwell_bienmang-eng.pdf

Healthwise Incorporated. (2012). *Spondylolysis and spondylolisthesis: exercises*. Retrieved from: <https://healthy.kaiserpermanente.org/health/care>

HealthyFridge.org. (2009). *Kids' quiz!*. Retrieved from <http://www.healthyfridge.org/kids1.html>

Health4y. (2011). *One exercise to lose your thigh fat*. Retrieved from: <http://www.health4y.com/1-exercise-to-lose-your-thigh-fat/>

how2muscleguide.com. (2013). *Shoulder Workout Routine*. Retrieved from: <http://www.how2muscleguide.com/shoulder-workout-routine.html>

Johnson, Brian (2010). *A Philosopher's notes*. Fountain Valley, CA: entheos Enterprises.

Lau Gar Kung Fu. (2013) *Part 3 – Preparing to stretch*. Retrieved from: <http://www.stafford-lau-gar.org/part3.html>

Physical Arts. (2000). *Front kick (Right Stance)*. Retrieved from: http://www.physical-arts.com/training/techniques/mn_front_kick_right.html

Popsugar Inc. (2013). *The best core exercises for runners*. Retrieved from: <http://www.fitsugar.com/Best-Core-Exercises-Runners-7102627>

Ratey, J. MD. (2008). *Spark: The revolutionary new science of exercise and the brain*. New York, NY: Little, Brown and Company.

Ron Johnson. (1996). *Office training exercises*. Retrieved from: http://www.hockeyschoolonline.com/Jumping_running.htm

Scott, E. (2007). *25 More of the top stress relievers*. Retrieved from http://stress.about.com/od/tensiontamers/a/25_relievers.htm

Spark People. (2012). *Portion distortion quiz*. Retrieved from http://www.sparkpeople.com/resource/quizzes_start.asp?quizid=32

Sharma, Robin (2009). *The greatness guide 2*. Scarborough, ON: Harper Collins.

Snapguide. (2013). *How to lose weight! BESTWORKOUTS From a personal trainer*. Retrieved from: <http://snapguide.com/guides/lose-weight-best-workouts-from-a-personal-trainer/>

Stack. (2013). *The Michael Jordan tested core workout*. Retrieved from: <http://basketball.stack.com/wp-content/uploads/2011/06/MJ-Core-Anterior-Reach-on-One-Leg.jpg>

Sun Key Publishing. (2013). *APFT calisthenics exercises*. Retrieved from: http://www.militaryspot.com/enlist/apft_calisthenics_exercises/

Tolle, Eckhart (2004). *The power of now*. Oakland, CA:New World Library

Ultimate Franchises Ltd. (2012). *Benefits and proper execution of squats*. Retrieved from:<http://www.ukbkickboxing.com/benefits-and-proper-execution-of-squats>

Weider Publications, LLC. (2013). *Bikini-belly bootcamp sculpt flat abs for summer with these fat-melting moves*. Retrieved from: http://www.google.ca/imgres?imgurl=http://www.shape.com/sites/shape.com/files/imagecache/gallery_full_image/photo_gallery_picture_images

Women's Health. (2013). *Work out at home*. Retrieved from: <http://www.womenshealthmag.com>

60 Days with Nat Jones. (2013). *FITNESSBUILDER*. Retrieved from: <http://www.60dayswithnatjones.com>

EOs M504.02 and M504.03

Anderson, B. (2000). *Stretching: 20th anniversary* (Rev. ed.). Bolinas, CA: Shelter Publications, Inc.

THIS PAGE INTENTIONALLY LEFT BLANK

TABLE OF CONTENTS

		PAGE
CHAPTER 1		
Section 1	EO C501.01 – REFLECT UPON WHAT IT MEANS TO BE A GOOD CANADIAN CITIZEN.....	C501.01-1
Annex A	CANADIAN CITIZENSHIP.....	C501.01A-1
Section 2	EO C501.02 – REFLECT UPON INDIVIDUAL GLOBAL CITIZENSHIP.....	C501.02-1
Annex A	GLOBAL CITIZENSHIP.....	C501.02A-1
Section 3	EO C501.03 – ANALYZE A GLOBAL ISSUE.....	C501.03-1
Annex A	ANALYZE A GLOBAL ISSUE.....	C501.03A-1
Appendix 1	UN BRIEFING PAPER ON CHILD LABOUR	C501.03A1-1
Appendix 2	UN BRIEFING PAPER ON BIODIVERSITY	C501.03A2-1
Appendix 3	UN BRIEFING PAPER ON POVERTY	C501.03A3-1
Appendix 4	UN BRIEFING PAPER ON HUMAN RIGHTS	C501.03A4-1
CHAPTER 2		
	EO M502.01 – PERFORM 45 HOURS OF INDIVIDUAL COMMUNITY SERVICE.....	M502.01-1
Annex A	CASE STUDY: “FLIGHT SERGEANT KAYE AND GREEN NARROWS PARK”	M502.01A-1
Annex B	PERSONAL INVENTORY	M502.01B-1
Annex C	INVESTIGATION PLAN	M502.01C-1
Annex D	FOUR SQUARE REFLECTION TOOL	M502.01D-1
Annex E	COMMUNITY SERVICE CHECKLIST	M502.01E-1
CHAPTER 3		
Section 1	EO M503.01 – CREATE A PROPOSAL.....	M503.01-1
Attachment A	CREATE A PROPOSAL	M503.01A-1
Attachment B	CREATE A PROPOSAL AIDE-MÉMOIRE	M503.01B-1
Section 2	EO M503.02 – PREPARE AN EXERCISE.....	M503.02-1
Attachment A	M503.02A-1
Attachment B	EXERCISE PLAN EXAMPLE	M503.02B-1
Attachment C	EXERCISE PLAN TEMPLATE	M503.02C-1
Attachment D	GUIDED DISCUSSION WORKSHEET.....	M503.02D-1
Section 3	EO M503.03 – CONDUCT AN EXERCISE.....	M503.03-1
Section 4	EO M503.04 – CONCLUDE AN EXERCISE.....	M503.04-1
Attachment A	AFTER ACTION REPORT	M503.04A-1
Section 5	EO C503.01 – EXAMINE MEETING PROCEDURES.....	C503.01-1
Attachment A	EXAMINE MEETING PROCEDURES.....	C503.01A-1
Attachment B	C503.01B-1
Attachment C	EXERCISE PLAN EXAMPLE	C503.01C-1

TABLE OF CONTENTS (Cont)

	PAGE	
CHAPTER 4		
Section 1	EO M504.01 – PARTICIPATE IN THE CADET FITNESS ASSESSMENT AND IDENTIFY STRATEGIES FOR IMPROVING PERSONAL PHYSICAL FITNESS.....	M504.01-1
Annex A	STRATEGIES TO IMPROVE MY PERSONAL PHYSICAL FITNESS.	M504.01A-1
Annex B	PHYSICAL ACTIVITIES CADETS CAN DO TO IMPROVE THEIR PERSONAL FITNESS	M504.01B-1
Section 1	EO C504.01 – REFLECT ON PERSONAL FITNESS AND HEALTHY LIVING.....	C504.01-1
Annex A	C504.01A-1
Appendix 1	C504.01A1-1
Appendix 2	C504.01A2-1
Annex B	SOLUTIONS	C504.01B-1
CHAPTER 5		
Section 1	EO M507.01 – DEVELOP A PERSONALIZED SCHEDULE.....	M507.01-1
Attachment A	PROFICIENCY LEVEL FIVE POS AND EOS.....	M507.01A-1
Section 2	EO C507.01 – IDENTIFY SERVICE OPPORTUNITIES FOR A CADET INSTRUCTORS CADRE (CIC) OFFICER.....	C507.01-1
Attachment A	IDENTIFY SERVICE OPPORTUNITIES FOR A CADET INSTRUCTORS CADRE (CIC) OFFICER.....	C507.01A-1
Attachment B	C507.01B-1
Section 3	EO C507.02 – IDENTIFY VOLUNTEER OPPORTUNITIES WITH THE AIR CADET LEAGUE OF CANADA (ACLC).....	C507.02-1
Attachment A	IDENTIFY VOLUNTEER OPPORTUNITIES WITH THE AIR CADET LEAGUE OF CANADA (ACLC).....	C507.02A-1
Attachment B	SELF-STUDY PACKAGE ANSWER KEY.....	C507.02B-1
Attachment C	SPEAKER'S NOTE / AGENDA.....	C507.02C-1
Section 3	EO C507.03 – REFLECT UPON THE CADET EXPERIENCE.....	C507.03-1
Attachment A	REFLECT UPON THE CADET EXPERIENCE.....	C507.03A-1
CHAPTER 6		
	EO C509.01 – MONITOR INSTRUCTION.....	C509.01-1
Attachment A	MONITOR INSTRUCTION.....	C509.01A-1
Attachment B	SELF-STUDY PACKAGE ANSWER KEY.....	C509.01B-1
Attachment C	ASSESSMENT CHECKLIST	C509.01C-1
Attachment D	ASSESSMENT RUBRIC	C509.01D-1
CHAPTER 7		
	EO C530.01 – FLY A CROSS-COUNTRY FLIGHT USING A FLIGHT SIMULATOR.....	C530.01-1

TABLE OF CONTENTS (Cont)

	PAGE
Attachment A FLY A CROSS-COUNTRY FLIGHT USING A FLIGHT SIMULATOR..	C530.01A-1
CHAPTER 8	
EO C540.01 – REFLECT ON CANADA'S CONTRIBUTION TO AEROSPACE TECHNOLOGY.....	C540.01-1
Attachment A REFLECT ON CANADA'S CONTRIBUTION TO AEROSPACE TECHNOLOGY.....	C540.01A-1
Attachment B ANSWER KEY	C540.01B-1
CHAPTER 9	
Section 1 EO C560.01 – EXAMINE ASPECTS OF FLIGHT SAFETY (FS).....	C560.01-1
Attachment A EXAMINE ASPECTS OF FLIGHT SAFETY (FS).....	C560.01A-1
Attachment B ANSWER GUIDE	C560.01B-1
Section 2 EO C560.02 – EXAMINE THE CANADIAN BUSH PILOT INDUSTRY	C560.02-1
Attachment A THE CANADIAN BUSH PILOT INDUSTRY.....	C560.02A-1
Attachment B ANSWER KEY	C560.02B-1
CHAPTER 10	
EO C570.01 – EXAMINE THE ASPECTS OF AIRCRAFT MANUFACTURING AND MAINTENANCE THROUGH THE DEVELOPMENT OF AEROBATIC AIRCRAFT.....	C570.01-1
Attachment A ASPECTS OF AIRCRAFT MANUFACTURING AND MAINTENANCE THROUGH THE DEVELOPMENT OF AEROBATIC AIRCRAFT.....	C570.01A-1
Attachment B SELF-STUDY REVIEW ANSWER GUIDE	C570.01B-1
CHAPTER 11	
EO C590.01 – ANALYZE AN AIRCREW SURVIVAL CASE STUDY...	C590.01-1
Attachment A ANALYZE AN AIRCREW SURVIVAL CASE STUDY.....	C590.01A-1
Attachment B ACTIVATE YOUR BRAIN ANSWER KEY.....	C590.01B-1

THIS PAGE INTENTIONALLY LEFT BLANK



**COMMON TRAINING
PROFICIENCY LEVEL FIVE
INSTRUCTIONAL GUIDE**



SECTION 1

EO C501.01 – REFLECT UPON WHAT IT MEANS TO BE A GOOD CANADIAN CITIZEN

Total Time:

One session = 90 min

PREPARATION

PRE-LESSON INSTRUCTIONS

This IG supports EO C501.01 (Reflect Upon What it Means to be a Good Canadian Citizen) located in A-CR-CCP-805/PG-001, *Proficiency Level Five Qualification Standard and Plan*, Chapter 4.

Self-study packages are intended to be completed by the cadet independently. More information about self-study packages can be found in the foreword and preface.

Review the lesson content and become familiar with the material prior to facilitating this lesson.

Photocopy the self-study package located at Annex A for each cadet.

PRE-LESSON ASSIGNMENT

Nil.

APPROACH

A self study was chosen for this lesson as it allows the cadet to reflect upon Canadian citizenship at their own learning pace. This encourages the cadet to become more self-reliant and independent by focusing on their own learning instead of learning directed by the instructor.

INTRODUCTION

REVIEW

Nil.

OBJECTIVES

By the end of this lesson the cadet shall have reflected upon their role as a Canadian citizen.

IMPORTANCE

It is important for cadets to reflect upon citizenship to improve their understanding of what it means to be Canadian, and to guide them in becoming active and responsible citizens.

SELF-STUDY PACKAGE INSTRUCTIONS

OBJECTIVE

The objective of this self-study package is to have the cadet reflect upon Canadian citizenship.

RESOURCES

- Recent edition of a national newspaper or a printout of online national and international news,
- Self-study package,
- Pen / pencil, and
- Markers / pencil crayons.

ACTIVITY LAYOUT

- Provide the cadet with a classroom or training area suitable to complete the self-study package.
- Highlight news stories related to Canadian issues, identity, values, and citizenship (such as Canadian achievements, public opinion research, or activities of local elected officials) for the cadets to use.
- If the cadet has access to the Internet through a smartphone or tablet, you may permit them to use these items for the activity if they wish (for instance, to look up the names of local Members of Parliament). However, Internet access is not a requirement.

ACTIVITY INSTRUCTIONS

1. Provide the cadet with a copy of the self-study package located at Annex A and a pen / pencil.
2. Provide the cadet with the newspaper or news printout.
3. Allow the cadet 90 minutes to complete the self-study package.
4. Provide assistance to the cadet as required.
5. Collect the self-study package once the cadet has finished.
6. Correct the self-study package. Check to see that the cadet's responses show an understanding of the subject and evidence of genuine reflection.
7. Provide feedback to the cadet and indicate whether or not they have completed the Enabling Objective (EO).
8. Return the completed self-study package to the cadet for their future reference.
9. Upon the completion of the self-study package, record the result in the cadet's logbook and training record.

SAFETY

Nil.

END OF LESSON CONFIRMATION

The cadet's completion of the self-study package will serve as the confirmation of this lesson.

CONCLUSION

HOMEWORK / READING / PRACTICE

Nil.

METHOD OF EVALUATION

Nil.

CLOSING STATEMENT

Being a good citizen is about being informed, being actively involved, and helping contribute to the improvement of life in Canada. This is the responsibility of every Canadian, and is especially important for the young adults who will shape Canada's future.

INSTRUCTOR NOTES / REMARKS

Nil.

REFERENCES

Nil.

THIS PAGE INTENTIONALLY LEFT BLANK

Canadian Citizenship



SECTION 1: WHAT DOES IT MEAN TO BE CANADIAN?

SECTION 2: DEFINE GOOD CITIZENSHIP

SECTION 3: BEING A GREAT CANADIAN

Instructions

Read over some of the news stories you have been given. Then read each section of this exercise and answer the questions in the space provided. You don't have to write out your answers in full sentences—you may answer in point form, by drawing a chart, or by making a mind map. You can also include appropriate illustrations with labels to help convey your ideas if you wish. See examples below.

Q. What do you like about cadets and why?

Point form:

- Summer training and activities, because I get to meet new friends.
- Travelling, because I get to see different places.
- Mess food 😊 it tastes good (usually) and it's free.
- New experiences because I get to tell my friends at school about it.
- Marksmanship because it's something I couldn't do anywhere else.
- Sports – I can stay in shape and I like the teamwork.

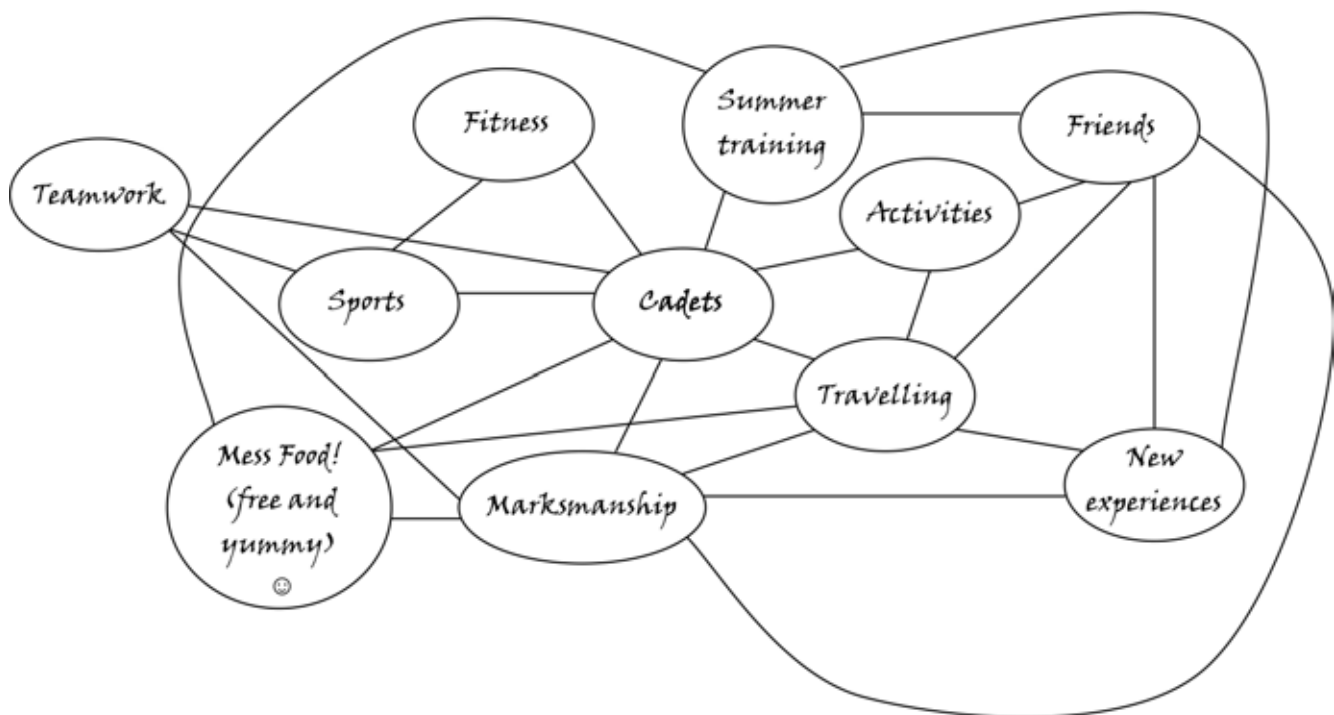

Table:

What I like	Why
Travelling	New friends and experiences
Summer Training	New friends and experiences
Sports	Fitness, teamwork
Marksmanship	Can't do it anywhere else
Mess food	Free and tasty

SECTION 1
WHAT DOES IT MEAN TO BE CANADIAN?

Part A: Canadian Identity – So, you drive a dogsled, right?

Read the quotations below and answer the questions. There is no “right” answer; however, your ideas must be thoughtful and well-supported. You can refer to the news stories you have read to support what you write.

Quotations about Canadians:

“There are no limits to the majestic future which lies before the mighty expanse of Canada with its virile, aspiring, cultured, and generous-hearted people.”

- Sir Winston Churchill, former Prime Minister of England

“In a world darkened by ethnic conflicts that tear nations apart, Canada stands as a model of how people of different cultures can live and work together in peace, prosperity, and mutual respect.”

- Bill Clinton, former U.S. President

“It's going to be a great country when they finish unpacking it.”

- Andrew H. Malcom, Canadian-born journalist living in the U.S.



Do you feel these quotations reflect how Canadians are usually seen by others? Explain.



Do you believe these quotations are accurate descriptions of Canadians as we really are? Why or why not?



List some stereotypes commonly applied to Canadians. These can be positive or negative, or neutral. Do you feel these stereotypes are accurate or justifiable? Explain.



If you could create new generalizations about Canadians, what would they be? What could you do to change people's perceptions about Canadians?

Part B: What Canada means to you

Read the quotations below and answer the questions. There is no “right” answer; however, your ideas must be thoughtful and well-supported. You can refer to the news stories you have read to support what you write.

Quotations about being Canadian:

"The Canadian Identity, as it has come to be known, is as elusive as the Sasquatch and Ogopogo. It has animated—and frustrated—generations of statesmen, historians, writers, artists, philosophers, and the National Film Board... Canada resists easy definition."

- Andre Cohen, journalist

"Canada has never been a melting-pot; more like a tossed salad."

- Arnold Edinborough, Canadian writer and broadcaster

"Canada is the essence of not being. Not English, not American, it is the mathematic of not being. And a subtle flavour - we're more like celery as a flavour."

- Mike Myers, Canadian actor



Are these quotations accurate reflections of Canadian identity? Support your opinions.



Write your own explanation of Canadian identity.

"I am a Canadian, free to speak without fear, free to worship in my own way, free to stand for what I think right, free to oppose what I believe wrong, or free to choose those who shall govern my country. This heritage of freedom I pledge to uphold for myself and all mankind."

- John Diefenbaker, former Prime Minister



List and explain at least five things that make you proud or happy to be Canadian.

“The tragedy of Canada today is that just when we need a country that's pulling together in common cause, we have one that keeps finding new ways to pull itself apart.”

- Angus Reid, CEO of Vision Critical



List at least five improvements you would like to make to life in Canada. Explain.

SECTION 2
DEFINE GOOD CITIZENSHIP



Who are some contemporary or historical Canadians you admire? What qualities do these individuals have that made you choose them?



If you could choose one image, colour, sound, song or word to symbolize how you feel about being Canadian, what would it be? Why? You can draw a picture or write a few lines of a song here if you wish.

Part A: What does it mean to be a good citizen?

Read the quotations below and answer the questions. There is no “right” answer; however, your ideas must be thoughtful and well-supported. You can refer to the news stories you have read to support what you write.

Quotations about citizenship:

“The first requisite of a good citizen... is that he shall be able and willing to pull his own weight.”

- Theodore Roosevelt, former U.S. President

“If the undocumented have to work hard to attain citizenship, those of us who already are citizens should have to work hard to sustain it. We should all have to serve more, build more, and do more for our country.”

- Eric Liu, Asian-American writer

“Citizenship is an attitude, a state of mind, an emotional conviction that the whole is greater than the part... and that the part should be humbly proud to sacrifice itself that the body may live.”

- Robert Heinlein, author of Starship Troopers



In what ways would a citizen “pull their own weight?” Do you agree that this is a prerequisite for citizenship? Why or why not?



Eric Liu points out that while immigrants must work hard to attain citizenship, many people who are born citizens take it for granted. Do you agree or disagree? Explain.



What responsibilities do you believe should come with citizenship? Do you agree with Liu's point of view? What about Robert Heinlein's? Explain.

"The test of good citizenship is loyalty to country."

- Bainbridge Colb, former U.S. Secretary of State

"The subject who is truly loyal to the Chief Magistrate will neither advise nor submit to arbitrary measures."

- Junius, 18th-century British political writer



In what ways would a citizen be loyal to their country? Think of the ways in which you are loyal to other people.



Is loyalty a matter of unquestioning obedience, or does loyalty call for people to question the government? What do you think? Explain.

Part B: What about being a citizen of Canada?

Read the quotations below and answer the questions. There is no “right” answer; however, your ideas must be thoughtful and well-supported. You can refer to the news stories you have read to support what you write.

“Above everything, we are Canadian.”

- Sir George Etienne Cartier, French-Canadian statesman and Father of Confederation

“If you don’t think your country should come before yourself, you can better serve your country by livin’ someplace else.”

- Stompin’ Tom Connors, Canadian singer and songwriter



Is being a Canadian citizen a major part of your identity? Explain.



In what ways could Canadians put their country ahead of themselves? Do you think they should? Why or why not?

SECTION 3 BEING A GREAT CANADIAN

"It is the task of the rising generation of Canadians to create a new confidence and a new sense of cultural and civic duty in Canada."

- Mitchell Sharp, Canadian politician

As a young Canadian, you have a chance to shape the future of the country for the better. Who knows what great innovations and improvements your generation may be able to introduce. But to be prepared to meet the challenges along the way, you need be **informed**, **involved** and **responsible**.

Part A: Being informed

In order to make good decisions as a citizen, you need to know what's going on. Some echo the opinions of friends, family members or public figures without taking the time to learn all the facts or think things through.

Part of being an adult is forming your own individual opinions, and as a citizen and a leader, it's your responsibility to make sure your opinions are informed.

Chances are you've heard people make comments like, "Oh, I'm voting for this party because my dad says they're the best," or "This guy online says people should be opposing the changes the government wants to make, so I'm going to a protest!"

You wouldn't let somebody else tell you to like a band you've never heard, or a movie you've never seen. Apply the same reasoning to the issues and decisions facing Canadians.

Here are some ways to become better informed:

1. **Keep up with the news** to stay informed about local, national, and international current events. You can read the news, watch it, listen to it, or even have updates sent to your communications devices from reputable online news sources.
2. **Make sure your sources are reliable.** The Internet, in particular, can be a haven for misconceptions and prejudice, but other sources of information can be biased, as well. Avoid forming an opinion based on just one or two sources, and always think critically about where the information is coming from and what goals the people disseminating it might have.
3. **Be familiar with government departments, policies and programs.** It takes only a few minutes to do an online search, or stop into a Service Canada office to pick up a pamphlet. Gaining an understanding of how government departments work and what services each offers will help you make sound decisions about political issues, and you may also discover a program to help you find a good job or pay for post-secondary education!
4. **Know your local municipal councilors, provincial / territorial representatives and Members of Parliament.** You don't have to hang out with them, but you should know their priorities, party affiliation, and any roles they've been assigned (eg, if they've been appointed to Cabinet or made a critic of a portfolio). Their offices can also assist you in understanding municipal, provincial, and federal programs, services, and laws.

How informed are you? Answer the questions below to find out!



List three provincial, national or international issues that are currently in the news, and explain how each affects you. You can use the news stories you have been given, or include news from other sources (and no, your favourite celebrity getting a new Chihuahua does *not* count as news).



What are some reliable sources of information you can think of? What are some unreliable ones? Explain.



List as many government departments as you can and explain how each could be important to you (hint: the Cadet Program is supported by a federal government department!).



What is the name of your local:

- Member of Parliament? (your federal representative)
- Provincial / territorial representative?
- Municipal councilors? (your representatives in your community)

How many of these people have you met in person? _____

If you had trouble answering some of these questions, don't worry—many people do!

And even if you were able to answer them easily, there's always room to grow.



List at least three things you can change in your routine to become better informed about current events, governance in Canada, and your democratic representation.

Part B: Being involved

As you know from your experiences in the Cadet Program, part of good citizenship is being an active member of your community and the country.

Most people are happy to complain about the way things are, but only a few will put in the effort to try to change things for the better. As a leader, you can inspire people to work together, but you can also contribute on your own.

Here are some easy things you can do to get involved:

- **Vote.** Voting is a responsibility of every Canadian over 18, but it's also a chance to have your say. Every vote matters, so take this duty seriously!
- **Volunteer.** Most communities have plenty of volunteer opportunities, and there are also organizations that let you volunteer in other parts of the country. If you lead a program at a Boys and Girls Club, or help out at an animal shelter, you're making a positive difference in your community and gaining valuable work experience that may make it easier for you to get a good job.
- **Get out there!** Attend community events, especially ones that support charity. Shop at local businesses when you can. Get to know your neighbours, and help them if you have a chance. If a government representative is giving a presentation or holding a "town hall" meeting, you can also attend these events, which are a way for citizens to interact with their representatives and find out more about issues that affect them.

How are you involved? Answer the questions below.

	What are some ways you contribute to improving your community or the country?
---	---



Give some other examples of things you could potentially do to get more involved or encourage other people to do so.



Name someone whose involvement has made life better in Canada or in your community. What sorts of things did this person do?

Part C: Being Responsible

As a Canadian citizen, you have responsibilities—everyone has something to contribute, and things are better when we all help out.

Here are some of the things responsible Canadians are expected to do:

1. **Work hard.** Do your best to get a good job, and work hard to keep it. There are government programs available to help people who lose their jobs or can't find work, but when these programs are abused, it affects everyone.
2. **Obey the law.** Laws exist to protect people, even if they may sometimes seem inconvenient. Respecting the speed limit might make you late for class, but it will prevent you from hitting another car and hurting yourself or someone else.
3. **Be respectful.** Canadians are known around the world for diplomacy and friendliness. Maintain our positive image by treating everyone in a respectful manner. Respect yourself, too, by maintaining a healthy lifestyle and by taking ownership instead of blaming your problems on somebody else.
4. **Preserve Canada.** Look after our natural and cultural treasures so that future generations can enjoy them.



What are five responsible things you have done recently that would reflect the items in the list of things responsible Canadians are expected to do?



How does responsible citizenship factor into your plans for the future? Give some examples.

Final Assignment:

Use this space to summarize your reflections on being a good Canadian citizen. You can make a mind map, write a short essay, or draw a collage of images.



Congratulations, you have completed your self-study package on EO C501.01 (Reflect Upon What it Means to be a Good Canadian Citizen). Hand the completed package to the Training Officer / Course Officer who will record your completion in your Proficiency Level Five logbook.



**COMMON TRAINING
PROFICIENCY LEVEL FIVE
INSTRUCTIONAL GUIDE**



SECTION 2

EO C501.02 – REFLECT UPON INDIVIDUAL GLOBAL CITIZENSHIP

Total Time:

One session = 90 min

PREPARATION

PRE-LESSON INSTRUCTIONS

This IG supports EO C501.02 (Reflect Upon Individual Global Citizenship) located in A-CR-CCP-805/PG-001, *Proficiency Level Five Qualification Standard and Plan*, Chapter 4.

Self-study packages are intended to be completed by the cadet independently. More information about self-study packages can be found in the foreword and preface.

Review the lesson content and become familiar with the material prior to facilitating this lesson.

Gather the required resources:

- a copy of the self-study package located at Annex A for each cadet;
- a globe or a digital or hard-copy world map;
- a national newspaper or printout of current international news stories; and
- a pen or pencil.

PRE-LESSON ASSIGNMENT

Nil.

APPROACH

A self study was chosen for this lesson as it allows the cadet to reflect upon global citizenship at their own learning pace. This encourages the cadet to become more self-reliant and independent by focusing on their own learning instead of learning directed by the instructor.

INTRODUCTION

REVIEW

Nil.

OBJECTIVES

By the end of this lesson the cadet shall have reflected upon individual global citizenship.

IMPORTANCE

It is important for cadets to reflect upon individual global citizenship because globalization affects daily choices in all aspects of their life. It will help them recognize, as they move into adulthood, the competitive challenge created by globalization in all aspects of Canadian life.

SELF-STUDY PACKAGE INSTRUCTIONS

OBJECTIVE

The objective of this self-study package is to have the cadet reflect upon individual global citizenship.

RESOURCES

- Self-study package,
- A globe, or a digital or hard copy world map,
- A national newspaper or a printout of current international news stories, and
- Pen / pencil.

ACTIVITY LAYOUT

Provide the cadet with a classroom or training area suitable to complete the self-study package.

ACTIVITY INSTRUCTIONS

1. Provide the cadet with a copy of the self-study package located at Annex A, a map of the world or globe, a national newspaper or printout of current international news, and a pen / pencil.
2. Allow the cadet 90 minutes to complete the self-study package.
3. Provide assistance to the cadet as required.
4. Collect the self-study package once the cadet has finished.
5. Correct the self-study package. There is no “right” answer—look for evidence of reflection and understanding of the subject, and be prepared to correct any misconceptions.
6. Provide feedback to the cadet and indicate whether or not they have completed the Enabling Objective (EO).
7. Return the completed self-study package to the cadet for their future reference.
8. Upon the completion of the self-study package, record the result in the cadet's log book and training record.

SAFETY

Nil.

END OF LESSON CONFIRMATION

The cadet's completion of the self-study package will serve as the confirmation of this lesson.

CONCLUSION

HOMEWORK / READING / PRACTICE

Nil.

METHOD OF EVALUATION

Nil.

CLOSING STATEMENT

Globalization is an ongoing phenomenon that affects all aspects of daily living, is most likely irreversible and will continue at an increased pace. Whether they realize it or not, everyone is a global citizen with a collective responsibility to ensure that the effects of globalization are beneficial—for Canadians and the world at large.

INSTRUCTOR NOTES / REMARKS

Nil.

REFERENCES

Byers, M. (2005). *Are you a 'global citizen'?* Retrieved October 5, 2009, from <http://thetyee.ca/Views/2005/10/05/globalcitizen/#>

Fairtrade Foundation. (2009). *What is fair-trade?* Retrieved December 4, 2009, from http://www.fairtrade.net/what_is_fairtrade.html

Fairtrade Mossley. (2012). Image of Fairtrade symbol. Retrieved March 24, 2012, from <http://fairtrademossley.org.uk/wp-content/uploads/2012/07/Hi-Res-CoIFM-Rblk-international-MARK1-JPEG.jpg>

Global Policy Forum. (2009). *Globalization*. Retrieved October 25, 2009, from <http://www.globalpolicy.org/globalization.html>

MyLearning. (2009). *Global citizens—Make an impact*. Retrieved November 15, 2009, from <http://www.mylearning.org/jpage.asp?jpageid=2015&journeyid=441>

Reuters. (2012). *Bangladesh's Worst-Ever Factory Blaze Kills Over 100*. Retrieved March 23, 2013 from <http://www.reuters.com/article/2012/11/25/us-bangladesh-fire-idUSBRE8AN0CG20121125>

Tapscott, D. (2009). *Grown up digital: How the net generation is changing your world*. New York: McGraw Hill.

Transfair Canada. (2009). *Transfair Canada*. Retrieved December 4, 2009, from <http://transfair.ca>

UN Focal Point on Youth. (2011). *How does globalization have positive and negative effects on you – and your friends' – efforts to secure a job?* Retrieved March 24, 2013 from http://www.unworldyouthreport.org/index.php?option=com_k2&view=item&layout=item&id=39&Itemid=147

WiseGEEK. (n.d.). *What is Globalization?* Retrieved March 23, 2013 from <http://www.wisegeek.org/what-is-globalization.htm>

GLOBAL CITIZENSHIP

Your place in the world



SECTION 1: WHAT'S GLOBALIZATION, AGAIN?

SECTION 2: BECOMING A GLOBAL CITIZEN

Instructions

Read over some of the news stories you have been given. Then read each section of this exercise and answer the questions in the space provided. You don't have to write out your answers in full sentences—you can answer in point form, by drawing a chart, or by making a mind map. You can also include appropriate illustrations with labels to help convey your ideas if you wish. See below for examples.

Point form:

Q. What do you like about cadets and why?

Point Form:

- Summer training and activities, because I get to meet new friends.
- Travelling, because I get to see different places.
- Mess food (- it tastes good (usually) and it's free.
- New experiences because I get to tell my friends at school about it.
- Marksmanship because it's something I couldn't do anywhere else.
- Sports – I can stay in shape and I like the teamwork.

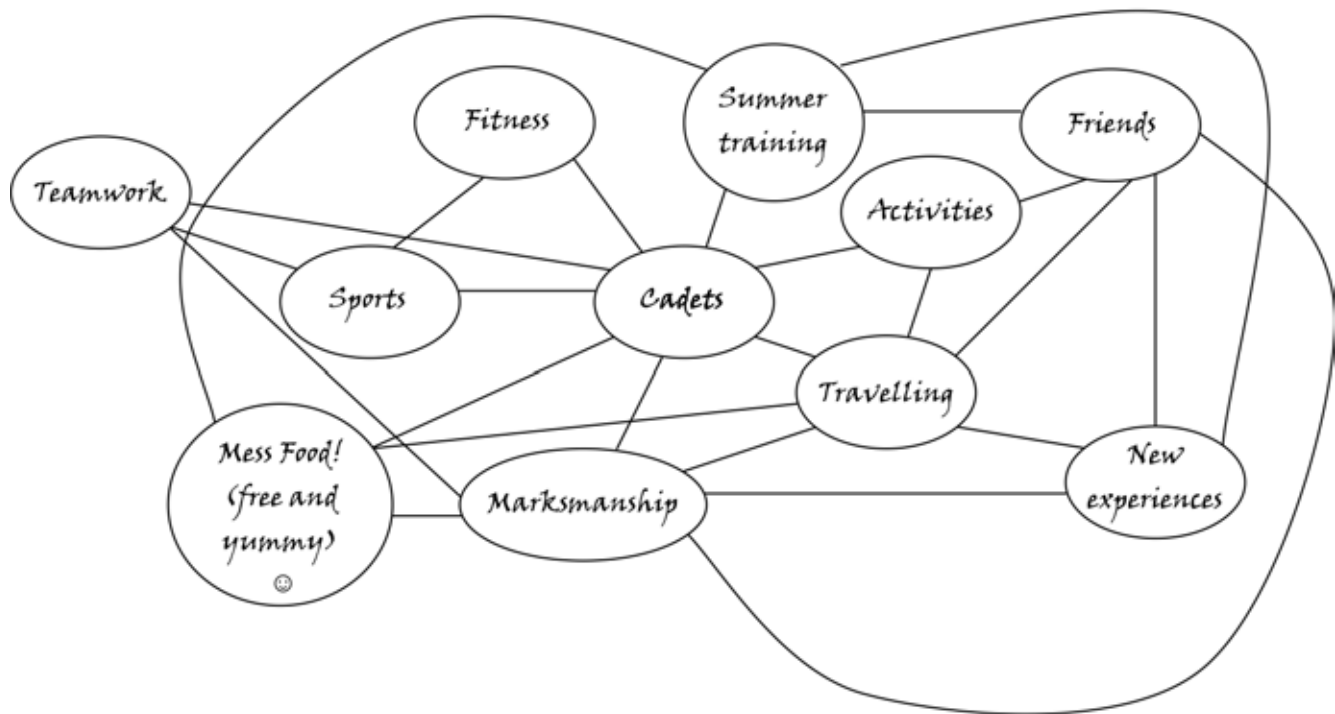

Table:

What I like	Why
Travelling	New Friends and experiences
Summer Training	New friends and experiences
Sports	Fitness, teamwork
Marksmanship	Can't do it anywhere else
Mess food	Free and tasty

SECTION 1 WHAT'S GLOBALIZATION, AGAIN?

INTRODUCTION

There was a time, not that long ago, when it took days to travel between one community and the next, when the only way to deliver a message was in person or in a letter, and when almost all the food people ate and the things they used came from their immediate geographic area.

Things have changed.

Today people can communicate instantly even if they're hundreds of miles apart, retrieve information from international online libraries and databases, and buy songs recorded on the other side of the globe—all with a tiny gadget that fits in a pocket. We can travel from Toronto to China in a matter of hours, and bring in fresh food and other products from almost anywhere on Earth.

Knowledge and ideas are shared more easily than ever before, across great distances and cultural barriers that would have once made such sharing impossible. Education is available to more people—a teacher can deliver a lesson to students in another country via new communications technology, and even check their homework afterwards!

We are also becoming more interdependent with other countries around the world. We rely on them for goods and services, and they rely on us. As a result, what happens in one country can affect people everywhere.

All of this is part of a phenomenon called **globalization**.

"[G]lobalization refers to the trend toward countries joining together economically, through education, society and politics, and viewing themselves not only through their national identity but also as part of the world as a whole. Globalization is said to bring people of all nations closer together, especially through a common medium like the economy or the Internet."

- WiseGeek.org

Specifically, globalization refers to the efficient movement across international borders of:

- goods, services and money,
- people (labour), and
- knowledge (technology).

People talk about three aspects of globalization: economic, political and cultural. Each has an impact on us.

Like it or not, we're not just Canadian citizens anymore. We're global citizens, part of a much bigger picture. But not everyone is a responsible global citizen.

As a leader, you can inspire other people to become better citizens of the world. This package will help you get started.

So... what's globalization got to do with me?

Most young adults in Canada have grown up surrounded by digital media that provide easy access to the world around us. Every day we use products from countless other countries without even realizing it, and embrace cultural influences from around the globe. It's not at all unusual for a Canadian teen to read Japanese manga, listen to Korean pop music, watch television shows from Europe, the U.S. or Australia, wear clothes made in China and eat food from India or South America, all in a single day.

Even as we become more connected to the world, however, Canadians—especially young Canadians—are often accused of being disconnected, from the world and from our role in it.

Technology brings us closer together, but it also sometimes serves to isolate us. Have you ever been on a bus or in a crowded place, totally in your own world because you were listening to music, playing a game or communicating with a friend? It's nice to be able to tune out what's around us, but do we sometimes tune out too much?

Teens and young adults are often criticized for being out of touch, absorbed with ourselves or with pointless trivia. This line of thought holds that young people don't keep up with the news, and have no idea what's going on in the rest of the world, or even in their own country. Young people are major consumers, yet have no real concept of where their food, clothing, gadgets, fuel and ideas come from. They want to ride in the canoe, but they don't help paddle, and they don't pay attention to where they're headed.



Do you believe these opinions about youth and globalization are accurate? Why or why not?

ECONOMIC GLOBALIZATION: WHERE IN THE *WORLD* DID YOU GET THOSE SHOES?

Do you know where your stuff comes from? Chances are you have a man in the Caribbean to thank for your morning pastry, a child in Pakistan to thank for your running shoes, and a woman in Bangladesh to thank for those stylish jeans. Economic globalization means that goods and services (and the money to pay for them) are exchanged readily between different nations, even those that are far apart. It also means that we depend on other nations far more than we once did, and they depend on us.



Make a list of things that you use or eat on a regular basis that are made here in Canada.

How long is your list? Was it difficult to make? Sometimes even things we consider to be Canadian are actually made from ingredients that come from somewhere else. Check out the list below—you might be surprised! As you read, try to pinpoint each country on your map or globe.

Clothing

- **Shirts.** Shirts and other clothing made of cotton are often made in countries such as **Malawi** and **India** because cotton grows best in warm climates.
- **Jeans.** Many types of jeans are made in Bangladesh by women who work on the factory production line.

- **Footwear.** Many types of footwear are made in the **U.S., Burma and Thailand.**

Breakfast

- **Orange juice. Brazil,** with its warm climate, is the world's largest producer of oranges.
- **Tea.** Many types of tea come from **Sri Lanka**, where tea plants are grown in plantations called tea estates. "Pickers" take the green leaves off the plant and then let them dry, so that they can be ground down into tea.
- **Cereal.** Cereals are made mainly from rice and maize (corn). **Argentina** is a major provider of cereal to Canada.
- **Coffee.** Coffee is really the seed of a fruit called the coffee cherry. Cherries are picked from a coffee plant, which grows in warm, humid climates. The fruit is removed by drying or fermenting, and the green coffee beans are roasted, ready to be brewed into the drink we know and love. The five biggest coffee producers are **Columbia, Vietnam, Kenya, Cote d'Ivoire (Ivory Coast)** and the U.S. State of **Hawaii.**

Treats

- **Chocolate.** Most chocolate comes from the **Ivory Coast** in West Africa.
- **Sugar.** Sugar comes mainly from countries in the Caribbean like **Jamaica.**

Lunch

- **Bananas.** Many of the bananas Canadians eat are grown in **Ecuador.**
- **Grapes.** Grapes are grown all over the world, but those from **Greece** are most popular.
- **Potato crisps.** Many varieties of crisps are made from dehydrated or dried potatoes. Some of the companies that produce dehydrated potatoes are in **Belgium.**

Dinner

- **Rice.** Rice is grown from seed in "paddy" fields in Asian countries such as **Vietnam.**
- **Chicken.** Many frozen chicken products, such as chicken nuggets, are made with chicken from **Thailand** and **Brazil.**
- **Beef. Argentina** is a major supplier of beef to Canada.
- **Cheese.** One of the most popular cheese-making countries is **France.**

Activities

- **Sports.** Many sports companies have factories in Asian countries, such as **Pakistan.**
- **Automobiles.** Most cars and other vehicles are made in the **US, Germany, Japan** and **Korea.**
- **Toys and gadgets.** Many plastic toys, video games and puzzles are made in **Taiwan.** Several camera companies also have their factories there.
- **Pens and pencils.** Many of the pens and pencils that you use are made in **China.**



Based on the list above and your own experience, list the countries you have depended on today and what you got from each country.

China makes more than just wheat and pencils. In fact, China is the largest exporter of clothing in the world, and of countless other items, as well. Canadians would have a hard time getting through a whole day without using anything from China!

China has long had a strong relationship with American corporation Wal-Mart, producing millions of dollars worth of stock for Wal-Mart shelves each year. Next time you visit a Wal-Mart, check to see how many of the items you buy have made the journey here from China.

It's not all sunshine and butterflies...

Economic globalization has made life better in a lot of ways, but it has its downsides, too.

For one thing, the interdependence between nations means that if something like a war or a natural disaster strikes a supplier country, all the countries it normally exports to will also be affected. Prices for items like fuel or bread will rise in Canada if our suppliers of oil and wheat experience problems.



Look at the news stories you have been given, and think of others you have heard of recently. Which stories might have an international or global impact on the economy?

Another drawback to economic globalization is that because the corporations that buy the product are so far away from the people who produce it, they may have little control over how workers are treated by their suppliers. While factories and plantations provide jobs for people in developing countries, they're not always good jobs. A product that is quite expensive in Canada may have been made by a factory employee thousands of miles away who is being paid very little and working in unsafe conditions.

In 2012, there was a fire at a factory in Bangladesh that, through an unscrupulous supplier, provided clothing to department stores like Sears and Wal-Mart. Unbeknownst to the corporations that would eventually sell the

clothes, the factory had no emergency exits and no working fire extinguishers—conditions that would never be acceptable in North America. Over 100 people died in the fire, most of them women. This tragedy prompted a movement for corporations to ensure their suppliers were treating workers properly, and providing them with safe places to work.



If you were the head of a major corporation, what steps would you take to ensure workers in developing countries were treated properly?

Since the early 1990s, the fair trade movement, including the organization Fairtrade International, has worked to ensure that producers and workers in developing countries get a better deal.

FINE, an informal association of four international fair trade networks, has developed a widely-used definition of fair trade:

Fair trade is a trading partnership, based on dialogue, transparency and respect, that seeks greater equity in international trade. It contributes to sustainable development by offering better trading conditions to, and securing the rights of, marginalized producers and workers – especially in the South. Fair trade organizations, backed by consumers, are engaged actively in supporting producers, awareness raising and in campaigning for changes in the rules and practice of conventional international trade.



Did you know?
One way for you to act as a global citizen is to support companies that conduct business responsibly in developing countries. Look for this symbol on products in your neighbourhood:



Figure A-1 Figure Fairtrade Symbol

TransFair Canada is a national, nonprofit fair trade certification organization, and the only Canadian member of Fairtrade International. What it does can be broken down into three main categories:

- **Certification.** TransFair Canada is responsible for certifying that Canadian products bearing the Fair Trade certification marks meet international Fair Trade standards. It also monitors products once they enter Canada to ensure that what is sold as Fair Trade Certified meets that standard.
- **Licensing.** TransFair Canada licenses Canadian companies to use the Fair Trade certification marks on their products, and ensures that these marks are not used in a way that is misleading to the public.
- **Promotion.** TransFair Canada works alongside community groups, companies, and individual citizens to promote and build momentum for Fair Trade certified products through media campaigns and promotional materials.

Economic Globalization and Employment

Sure, economic globalization is good for people in a lot of ways, but will it help you land a good job?

Young adults from around the globe were asked that same question as part of the United Nations World Youth Report in 2011. Some said globalization was positive for employment, because governments are opening up their borders and creating programs that encourage students to travel abroad and gain valuable international experience, or to move to another country if they can't find a good job in their own. As well, globalization has encouraged the setup of new industries and businesses—particularly information technology—in countries where good employment was desperately needed.

On the other hand, some youth felt globalization created even more competition for already-scarce jobs, since experienced workers could move in and take jobs that might otherwise have gone to young local workers. Others felt that globalization hurts developing countries, who are losing all their skilled workers to jobs in developed nations.

	What do you think? What effect does globalization have on employment for young Canadians? You can elaborate on the points above or explain your own.
---	--

POLITICAL GLOBALIZATION

Traditionally, politics takes place within national political systems. National governments, such as the Government of Canada, are responsible for maintaining the security and economic welfare of their citizens, as well as the protection of human rights and the environment within their borders.

Citizens normally pay attention to political activities within their own country, but globalization means that we need to be aware of politics on an international level. One consequence of living in a global world is that the

decisions and actions of international organizations affect countries and people all over the world. Some of these include the following:

- **The World Bank Group** is a source of financial and technical assistance to developing countries around the world. It is not really a bank, but an organization made up of 186 member countries. Together, they provide low-interest loans and interest-free grants to developing countries for education, health, public administration, infrastructure, financial and private sector development, agriculture, and environmental and natural resource management;
- **The International Monetary Fund (IMF)** is the world's central organization for international monetary cooperation. Its primary purpose is to ensure the stability of the system of currency exchange rates and international payments that enable countries to buy goods and services from each other; and
- **The World Trade Organization's (WTO)** primary purpose is to open trade for the benefit of all. The WTO helps negotiate agreements aimed at reducing obstacles to international trade, and helps implement and monitor these agreements as well as settle trade disputes between countries. The WTO currently has 153 members, of which 117 are developing countries.



The World Bank, the IMF, and the WTO have tremendous power and influence, but are often accused by citizens around the world of excluding the opinions of the developing countries they are supposed to help, and who are the most seriously affected by their policies. They claim that policies of these organizations are often developed behind-the-scenes and are heavily influenced by the larger and wealthier member countries.

Non-Governmental Organizations

Political globalization has also brought about the creation of non-governmental organizations (NGOs). These are groups and institutions entirely or largely independent of government, whose objectives are mainly humanitarian rather than commercial.

NGOs include charitable and religious associations that raise private funds for development, distribute food, offer family planning services, and promote community organization, to help people in developing countries. As well, they include independent cooperatives, community associations, water-user societies, women's groups and pastoral associations. Citizen groups that raise awareness and influence policy are also considered NGOs.

Members of these and other organizations act globally by forming alliances with organizations in other countries, and using global communications systems to influence international organizations instead of working through their national governments.

NGOs are always in need of support and volunteers, and some also offer employment opportunities abroad. Be sure to do your research before becoming affiliated with an NGO, however, because like anyone else, they can sometimes have their own agendas. Stick to NGOs that are internationally recognized and supported. Some examples of NGOs include Doctors without Borders, UNICEF, World Wildlife Fund, and Oxfam.

GLOBALIZATION OF CULTURE

With all our advancements in communications technology, the world is well on its way to developing a global culture. It is easier than ever for people to share cultural traditions, values and ideas across geographic barriers, and to seek out others with shared interests. Cultural boundaries are disappearing as people learn about and adopt new ways of thinking and acting.



Think of your interests and hobbies. Consider things like music, dance, art, sports, books, movies, and even food. Which cultural influences do you see?

A global culture has its upsides, but it may have its downsides, too. While we may be on the verge of a global culture, the spread of values and behavioural norms in that culture tends to be tilted strongly in favour of Western ideals. Over 80% of all websites in the world are in English and the majority of published material, including educational publications, on the Internet is in English. Small cultures and languages may be in danger of disappearing due to the competition in the international marketplace, where only the biggest international publishing and entertainment companies are able to produce high quality electronic materials. Global entertainment companies and other major corporations also influence culture through their marketing, which tends to lean towards Western traditions.



What do you think? Would a global culture, common to everyone in the world, be a good thing? Explain.

SECTION 2 BECOMING A RESPONSIBLE GLOBAL CITIZEN

Even though there are differing opinions, most people agree that global citizenship goes beyond simply knowing that everyone is a citizen of the planet, and reflects more the idea that all citizens of the planet have a collective responsibility to each other and the planet itself. In this regard, everyone belongs to one community, the planet, and consequently has a stake in the well-being of that community and its people.

As citizens of the global society, many young Canadians have a keen desire to give and volunteer, especially with hands-on ways of improving the lives of people, domestically and internationally. We believe that we can change the world one donation, one voluntary activity, or one purchase at a time.

What can you do to become a better global citizen? Some suggestions include:

- Educate yourself about different regions of the world.
- Make ethical choices in your personal life and protect the environment.
- Participate in your own community and contribute to its well-being.
- Don't be apathetic; take an interest in what's going on.
- Constantly improve your communication skills and express yourself appropriately.
- Treat people as you want to be treated.
- Learn about different cultures, and share your culture.
- Interact with people from diverse cultures and challenge injustice if necessary.
- Pick a good cause and advocate for it.
- Reflect on your actions.
- Gain awareness of global affairs, and local and global issues.
- Believe that people can make a positive change in the world, and lead by example.

There are numerous examples of young people who have done great things. Canadian Michael Furdyk is one of them.



Did you know?

Michael Furdyk was born in Toronto, Canada in 1982. When he was in ninth grade, he and a couple of his friends launched an online magazine about computers called MyDesktop.com. In May 1999, when Michael was in the eleventh grade, they sold it for over \$1 million. In October 1999, Michael and his friend Jennifer Corriero started TakingItGlobal, which is an online space where young people can work together with others around the world to do something good. As of 2009, ten years later, the site had members all over the world. Only 30% of its members are from North America, and the conversation takes place in 248 languages. (Don Tapscott, *Grown up Digital*, p. 280)

You could be the next Michael Furdyk. There are several simple things you can do to become engaged in a digital world, such as:

1. Join a social networking site or even create your own. It's an easy way to connect with old friends or meet new ones who share your interests. Promote your cause online.

2. Share websites you like and find out what sites your friends are reading by using free social bookmarking.
3. Share photos of issues that are important to you.
4. Find videos relevant to a cause you care about, or create your own and post them online.
5. Champion a cause by creating and personalizing a charity badge or widget. Email the link of your charity badge to family, friends and other contacts, or post it online.
6. Use micro-blogging sites such as Twitter to get your information out there and attract others to your cause.
7. Start a blog and invite your friends. Encouraging readers to leave comments is a great way to start online conversation.
8. Volunteer online. Various online programs, such as *In2Books* allow you to choose when and where to give your time.
9. Create online petitions to help promote the causes most important to you.
10. Donate to various causes through your cell phone. Text-to-give campaigns let donors make a secure donation to the cause they care about.



Based on what you have read in this section, develop a plan for being a better global citizen. You can include ideas from the chapter or come up with your own.

If you were to explain global citizenship to a junior cadet or a random person at the mall, what sort of things would you tell them? Sum up the information in this package in a way they could understand. Remember, you can make a mind-map, write a short essay, or even draw appropriate illustrations.



Congratulations, you have completed your self-study package on EO C501.02 (Reflect Upon Individual Global Citizenship). Hand the completed package to the Training Officer / Course Officer who will record your completion in your Proficiency Level Five logbook.



**COMMON TRAINING
PROFICIENCY LEVEL FIVE
INSTRUCTIONAL GUIDE**



SECTION 3

EO C501.03 – ANALYZE A GLOBAL ISSUE

Total Time:

One session = 90 min

PREPARATION

PRE-LESSON INSTRUCTIONS

This IG supports EO C501.01 (Reflect Upon What it Means to be a Good Canadian Citizen) located in A-CR-CCP-805/PG-001, *Royal Canadian Air Cadets Proficiency Level Five Qualification Standard and Plan*, Chapter 4.

Self-study packages are intended to be completed by the cadet independently. More information about self-study packages can be found in the foreword and preface.

Review the lesson content and become familiar with the material prior to facilitating this lesson.

Gather the required resources:

- a copy of the self-study package located at Annex A for each cadet,
- a national newspaper,
- a pen or pencil, and
- an Internet-enabled computer terminal / smart phone / tablet, if one is available.

PRE-LESSON ASSIGNMENT

Nil.

APPROACH

A self study was chosen for this lesson as it allows the cadet to analyze a global issue at their own learning pace. This encourages the cadet to become more self-reliant and independent by focusing on their own learning instead of learning directed by the instructor.

INTRODUCTION

REVIEW

Nil.

OBJECTIVES

By the end of this lesson the cadet will have analyzed a global issue.

IMPORTANCE

It is important for cadets to develop the ability to analyze an issue and understand it within the local, national, and international context as these are key skills necessary for being a good global citizen.

SELF-STUDY PACKAGE INSTRUCTIONS

OBJECTIVE

The objective of this self-study package is to have the cadet analyze a global issue.

RESOURCES

- Self-study package,
- National newspaper,
- Internet-enabled computer terminal / smart phone / tablet, and
- Pen / pencil.

ACTIVITY LAYOUT

Provide the cadet with a classroom or training area suitable to complete the self-study package.

ACTIVITY INSTRUCTIONS

1. Provide the cadet with a copy of the self-study package located at Annex A, a national newspaper, a pen / pencil, and, if available, access to an Internet-enabled computer terminal / smart phone / tablet.
2. From the following list, have the cadet select either two United Nations (UN) briefing papers, or one UN briefing paper and one Canadian Armed Forces (CAF) current international operation to read and analyze:
 - a. UN briefing papers located at Appendices 1–4 of Annex A,
 - b. UN briefing papers located at www.un.org/cyberschoolbus/briefing, and / or
 - c. CAF current international operations located at www.forces.gc.ca > OPERATIONS (www.forces.gc.ca/site/operations/index-eng.asp).
3. Allow the cadet 90 minutes to complete the self-study package.
4. Provide assistance as required to the cadet.
5. Collect the self-study package once the cadet has finished.
6. Correct the self-study package. Look for evidence of thought and reflection and substantiated ideas.
7. Provide feedback to the cadet and indicate whether or not they have completed the Enabling Objective (EO).
8. Return the completed self-study package to the cadet for their future reference.
9. Record the result in the cadet's logbook and training record.

SAFETY

Nil.

END OF LESSON CONFIRMATION

The cadet's completion of the self-study package will serve as the confirmation of this lesson.

CONCLUSION

HOMEWORK / READING / PRACTICE

Nil.

METHOD OF EVALUATION

Nil.

CLOSING STATEMENT

The world continues to face a number of global issues. Being able to analyze these issues and understand them within the context of Canada are key components of being a good global and Canadian citizen.

INSTRUCTOR NOTES / REMARKS

Nil.

REFERENCES

United Nations (n.d.). *Briefing Papers for Students*. Retrieved March 26, 2013, from <http://cyberschoolbus.un.org/briefing/index.asp>

Canadian Forces (2013). *Canadian Forces Operations*. Retrieved March 26, 2013, from <http://www.forces.gc.ca/site/operations/index-eng.asp>

Analyze A Global Issue



SECTION 1: PARAMETERS OF A GLOBAL ISSUE

SECTION 2: GLOBAL TO LOCAL

SECTION 3: REFLECTION

SECTION 1 PARAMETERS OF A GLOBAL ISSUE

RESPONSIBILITIES OF GLOBAL CITIZENS

Some issues are of such a scale that they either involve the entire international community directly or have implications for the entire world.



Do global citizens, such as yourself, have a responsibility for knowing about international issues? If so, what type of information should an informed global citizen know about international issues? Record five points below:

READ ABOUT TWO GLOBAL ISSUES

1. Select and read either two United Nations (UN) briefing papers, or one UN briefing paper and a current international Canadian Armed Forces (CAF) operation overview.



The UN briefing papers provided are:

- Child Labour located at Appendix 1,
- Biodiversity located at Appendix 2,
- Poverty located at Appendix 3, and
- Human Rights located at Appendix 4.

Additional UN briefing papers are located at www.un.org/cyberschoolbus/briefing.

Information regarding a current international CAF operation may be found at www.forces.gc.ca > OPERATIONS (www.forces.gc.ca/site/operations/index-eng.asp) (be sure to review the related links at the bottom of the operation's page).

2. Review a provided national newspaper (hard copy or online) to search for articles related to the global issues you have selected.
3. Complete the Key Facts sheets and answer the questions on the following pages. Include information / make reference to the newspaper article when answering the questions.

IDENTIFY THE PARAMETERS OF TWO GLOBAL ISSUES

Key Facts

ISSUE:
Who Identify those most affected by the issue and those involved in addressing it.
What Summarize the issue in two or three short sentences.
Where Identify locations where the issue is occurring.
When Identify when the timeline on the issue starts and when it can be predicted to end.
Why List some of the main causes of the issue.

Key Facts

ISSUE:
Who Identify those most affected by the issue and those involved in addressing it.
What Summarize the issue in two or three short sentences.
Where Identify locations where the issue is occurring.
When Identify when the timeline on the issue starts and when it can be predicted to end.
Why List some of the main causes of the issue.

SECTION 2
GLOBAL TO LOCAL

Place the issues in your local context by responding to the following questions:

	To what extent do the global issues you looked at exist in your community?
---	--

	If they do not exist, or exist very limitedly, why is that? What strategies to address the issues have been used? If one or both of the issues does exist in your community, what efforts are being made to address it or them?
--	---

Even the most distant issue can have some connection to Canada and your hometown. For example, extreme weather events, such as flooding, can be due to changing climate patterns, which is linked to the level of carbon dioxide in the air. Ensuring that there are viable alternatives to driving, such as public transit, is then connected to prevention of events such as flooding. This is not to say that Canadians are responsible for weather catastrophes around the world, but there is nonetheless a connection between communities here and effects there.



Are there causal connections between your community and the issues you reviewed? If so, what are they?

SECTION 3
REFLECTION

Now that the issue has been placed in the national and local context, discuss your personal connection to the issue by answering the following questions:



How did reading about the issues make you feel?



How do you feel about Canada's / your local community's connection to these issues?



Do you now plan to take any action regarding these issues? If so, what? If not, why not?



Congratulations, you have completed your self-study package on EO C501.02 (Analyze a Global Issue). Hand the completed package to the Training Officer / Course Officer who will record your completion in your Proficiency Level Five logbook.

UN Briefing Paper on Child labour

Overview

"...to enable families living in poverty to survive, a quarter of a billion children aged 14 and under, both in and out of school, now work, often in hazardous or unhealthy conditions...Having approved the International Labour Organisation convention on the worst forms of child labour, Member States must now implement it fully."

Secretary-General Kofi Annan in the *Millennium Report*

Vital Statistics

- Some 250 million children between the ages of 5 and 14 work either full time or part time.
- Almost half, some 120 million work full time, every day, all year round.
- Some 61 per cent of them live in Asia; 32 per cent in Africa and 7 per cent in Latin America.
- 70 per cent of them work in agriculture.
- 70 per cent work in dangerous environments.
- Of the 250 million children concerned, some 50-60 million are between five and 11 years and work, by definition, in hazardous circumstances, considering their age and vulnerability.
- Child labour is also common in developed countries. For example, in the United States, more than 230,000 children work in agriculture and 13,000 in sweatshops.

The story of Iqbal

Iqbal was only four when he was sold into slavery. He was a child of bondage, sold by his family to pay for a debt. Though very small and very weak, he was forced to work at a carpet factory for 12 hours a day. He was constantly beaten, verbally abused and chained to his loom for six years. Severe malnutrition and years of cramped immobility in front of a loom stunted his growth.

All this changed in 1992, when Iqbal and some of his friends from the carpet factory stole away to attend a freedom day celebration organized by a group working to help end bonded labour. With their help, Iqbal, too, became free and soon became a well known critic of child labour. His campaign scared many, especially those who used children as bonded labour. In December 1994, Iqbal visited the United States to receive a human rights award. Soon after his return, Iqbal was killed by a gunman hired by factory owners.

Iqbal was just one of over 250 million child labourers worldwide, but his story has inspired many to act for change.

What is Child Labour?

Among adults the term 'child labour' conjures up a particular image: children chained to looms in dark mills and sweatshops, as if in a long nightmarish line running from Lancashire in the 1830s right through to the South Asia of today.

In reality, children do a variety of work in widely divergent conditions. This work takes place along a continuum, from work that is beneficial, promoting or enhancing a child's development without interfering with schooling, recreation and rest to work that is simply destructive or exploitative. There are vast areas of activity between these two poles.

It is at the most destructive end, where children are used as prostitutes or virtual slaves to repay debts incurred by their parents or grandparents or as workers in particularly hazardous conditions, that efforts are focused to stop such abuse.

Who is a child labourer?

The term "child labour" generally refers to any economic activity performed by a person under the age of 15, defined by the International Labour Organisation (ILO) of the United Nations. On the beneficial side of the continuum, there is "light work" after school or legitimate apprenticeship opportunities, such as helping out in the family business or on the family farm. At the destructive end is employment that is:

- preventing effective school attendance; and
- hazardous to the physical and mental health of the child.

Many countries make a distinction between light and hazardous work, with the minimum age for the former generally being 12, for the latter usually varying between 16 and 18.

Are age limits for work the same in all countries?

Almost everywhere, age limits formally regulate children's activities - when they can leave school; marry; vote; be treated as adults by the criminal-justice system; join the armed forces; and when they can work.

But age limits differ from activity to activity and from country to country. The legal minimum age for all work in Egypt, for example, is 12; in the Philippines 14, in Hong Kong, 15. Peru adopts a variety of standards: the minimum age is 14 in agriculture; 15 in industry; 16 in deep-sea fishing; and 18 for work in ports and seafaring.

Many countries make a distinction between light and hazardous work, with the minimum age for the former generally being 12, for the latter usually varying between 16 and 18. ILO conventions adopt this approach, allowing light work at age 12 or 13, but hazardous work not before 18. The ILO establishes a general minimum age of 15 years, provided 15 is not less than the age of completion of compulsory schooling. This is the most widely used yardstick when establishing how many children are currently working around the world.

What is hazardous work?

Most child labour, 71 per cent, is found in agriculture and fishing. The main tasks in agriculture include working with machinery, agrochemicals, picking and loading crops. Hazards may include unsafe machinery, hazardous substances (insecticides, herbicides) heavy lifting and extreme temperatures. In deep sea fishing, children might be diving to depths of up to 60 metres to attach nets to coral reefs, risking exposure to high atmospheric pressure and attacks by carnivorous and poisonous fish.

In manufacturing where 8.3 per cent of child labour is found, items such as glass bangles, matches, fireworks or bricks might be made. Hazards occur in the form of noxious fumes and radiant heat from the molten glass; stepping on or handling hot broken glass; exposure to hazardous chemical mixtures; stuffing cracker powder into fireworks, risking fire and explosion; exposure to silicate, lead and carbon monoxide, carrying excessive weights; and burns from ovens through the processing of clay in the making of bricks.

A legal framework against child labour

Two UN agencies have directed their attention to the prevention of child labour worldwide: the United Nations Children's Fund (UNICEF) and the International Labour Organisation (ILO). They have helped define the problems and develop international legal frameworks to correct them. As a result of their work, we now have several international treaties (or Conventions), banning child labour and identifying concrete measures for Governments to take. Once a country ratifies a convention, UN bodies monitor compliance and hold countries accountable for violations.

1919: The first ILO child labour convention, the Minimum Age (Industry) Convention No. 5, adopted within months of the creation of the International Labour Organisation, prohibited the work of children under the age of 14 in industrial establishments.

1930: The ILO Forced Labour Convention No. 29 protected children from forced or compulsory labour, such as victims of trafficking, children in bondage, *like Iqbal*, and those exploited by prostitution and pornography.

1966: The International Covenant on Civil and Political Rights, reemphasizing issues of slavery and forced or compulsory labour, was adopted by the General Assembly, along with the International Covenant on Economic, Social and Cultural Rights calling for the protection of young people from economic exploitation and work hazardous to their development.

1973: The key instrument of the ILO was adopted: Convention No. 138 on the minimum age for admission to employment (15 or the age reached on completion of compulsory schooling)

1989: UN adopted Convention on the Rights of the Child specifying the right of the child to be protected from economic exploitation and hazardous work, and the refraining of states from recruiting any person under 15 into the armed forces.

1999: ILO unanimously adopts the Convention Concerning the Prohibition and Immediate Action for the Elimination of the Worst Forms of Child Labour Convention No. 182. It calls for states to prevent the most damaging child exploitation practices or the worst forms that currently exist.

Are making laws enough to prevent child labour?

Though the United Nations has already created a large number of international conventions, setting legal standards to prohibit the exploitation of child labour, the problem remains widespread. After all, laws mean very little if they are not enforced. Besides, specific measures attacking child labour must be taken at the national level.

According to the ILO, national strategies to address child labour issues should, at minimum, encompass the following five elements:

1. **National plan of action:** Single action or isolated measures against child labour will not have a lasting impact. Actions must be part of an overall national plan.
2. **Research:** To develop effective national (and international) policies and program, extensive research must be undertaken to determine the state of child labour.
3. **Awareness:** Child labour is often viewed as an unavoidable consequence of poverty. Without greater awareness about the extent and exploitative nature of child labour, the conditions for change will not occur.
4. **Broad social alliance:** Government action against child labour often ends with making laws. Initiatives against child labour traditionally come from non-Governmental organisations that have limited resources. Both need to work together. Other segments of civil society – the media, educators, artists and parliamentarians – should also be enlisted in the fight.
5. **Institutional capacity:** To formulate and execute a national policy, an institutional mechanism (such as a ministry or a department) within the Government must be created to monitor enforcement.

Signs of progress

- **Legal framework:** With over 20 international treaties against child labour in place, the world now has a legal framework. What is needed is its implementation at the national level.

- **International action:** ILO created the International Programme for the Elimination of Child Labour (IPEC) in 1992. It works toward eliminating child labour by helping developing countries strengthen their capacity to deal with the problem and create their own national action plans. So far it has helped implement more than 1,100 programmes in some 20 countries
- **Joining hands:** The United Nations wants to bring the Governments, factory owners and international donors together to work against child labour. Such initiatives as one between ILO, UNICEF and the Bangladesh Garment Manufacturers and Exporters Association were undertaken to remove underage workers from 2,000 garment factories, place them in school and provide family income supplements. UNICEF also pioneered a policy of not buying any products made by child labour in their operations. Some Governments have followed this example.
- **International solidarity:** Children, youth, concerned citizens and Government leaders in Asia, Africa, Europe, North and South America in 1998 took part in a march against child labour. This march travelled through 56 countries, gathered supporters and raised greater awareness, putting new pressure on Governments to ratify conventions on child rights.
- **Student advocacy:** More and more students are getting involved, raising funds to build schools and treatment centers for child workers. For example, Free the Children, a Canadian based student organisation advocating the elimination of child labour, formed by then 13-year old activist, Craig Kielberger, has raised funds to build schools in South Asia. The Kids Campaign to Build A School for Iqbal, a Massachusetts based grass roots student campaign initiated by a school in the United States, has drawn worldwide support to build a school for Pakistani children of bonded labour in honour of Iqbal Masih.
- **Corporate responsibility:** Growing concern has been shown by corporations to address this issue and develop corporate codes of conduct to reduce their numbers of underage employees / provide work to other members of the family or schooling to supplement work. For example, all major soccer ball manufacturers have developed a voluntary programme to eliminate use of children under 14 in factories in Sialkot, Pakistan, where 75 per cent of the world's hand-stitched soccer balls are produced. Supported by ILO, UNICEF and Pakistani manufacturers, a programme was launched to provide schooling for these child workers and instead give their jobs to other family members. In addition, many clothing manufacturers now hire outside companies to inspect working conditions in their factories. While some companies fund their investigators directly, others have agreed to independent monitors from human rights offices not employed by the corporations.
- **Advocacy by trade unions:** In Brazil, trade unions in cooperation with IPEC have managed to secure child labour clauses in contracts with employers in over 88 municipalities in over 8 federal states. In addition, employers have signed pledges to eliminate child labour from production chains of the charcoal, citrus and footwear sectors. Trade unions help by monitoring working conditions, denouncing abuses and reaching large numbers of adult members through education programmes, collective bargaining and campaigning for policy change at all levels.
- **Anti-sweatshop movement:** Campaign by labour rights groups has helped improve working conditions in "sweat shops". In several instances, multinational companies now put pressure on their contractors to ban or reduce child labour.

What are the areas needing attention?

UNICEF recommends the following:

- Immediately end hazardous and exploitative child labour -- including bonded labour, commercial sexual exploitation and work that hampers the child's development.

- Provide free and compulsory education - ensuring that children attend primary education full time until completion.
- Expand legal protection - ensure consistency and implementation in mutually supportive ways.
- Register all children at birth -- to protect the child's right to have evidence of the child's age.
- Extend data collection/ monitoring -- gather and analyse globally comparable child labour data.
- Develop codes of conduct and procurement policies -- Corporations should adopt codes of conduct guaranteeing that neither they nor their subcontractors will employ children in conditions that violate their rights and then abide by those codes.

Ratify ILO Convention No. 182 now!

The ILO Convention No. 182 is considered by many as perhaps the most significant legal instrument to tackle child labour. It defines the worst forms of child labour and asks all Governments to ban them. These are:

- All forms of slavery;
- Child prostitution;
- Using children for illicit activities, especially drug trafficking;
- Work exposing children to grave health and safety hazards.

Once Governments have ratified the Convention they must apply it in law and in practice. Among other things, Governments should:

1. Introduce action programs to remove and prevent the worst forms of child labour;
2. Provide direct assistance for rehabilitation of children and their social integration;
3. Ensure access to free education;
4. Identify children at special risk; and
5. Take account of girls and their special situation.

Governments must also report regularly to the ILO regarding the application of the Convention and be accountable for all allegations of violations.

THIS PAGE INTENTIONALLY LEFT BLANK

UN Briefing Paper on Biodiversity

Overview

"Environmental sustainability is everybody's challenge... Our goal must be to meet the economic needs of the present without compromising the ability of the planet to provide for the needs of future generations."

Secretary-General Kofi Annan in the *Millennium Report*

Vital Statistics

- Species have been disappearing at 50-100 times the natural rate, and this is predicted to rise dramatically.
- Based on current trends, an estimated 34,000 plant and 5,200 animal species – including one in eight of the world's bird species – face extinction.
- About 30 per cent of the main farm animal breeds are currently at high risk of extinction.
- Some 65 million hectares of forest have been lost in the developing world because of over-harvesting.
- Plant-based medicines provide more than 3 billion people with their primary health care.
- Fish catches have increased nearly fivefold during the last half-century, but almost 70 per cent of ocean fisheries are either fully exploited or over-fished.
- More than half the world's coral reefs are currently at risk.

Biodiversity – the web of life

Biological diversity – or biodiversity – is the term given to the variety of life on Earth and the natural patterns it forms. The biodiversity we see today is the fruit of billions of years of evolution, shaped by natural processes and, increasingly, by the influence of humans. It forms the web of life of which we are an integral part and upon which we so fully depend.

This diversity is often understood in terms of the wide variety of plants, animals and micro-organisms. So far, about 1.75 million species have been identified, mostly small creatures such as insects. Scientists reckon that there are actually about 13 million species, though estimates range from 3 to 100 million. Biodiversity also includes genetic differences within each species – for example, between varieties of crops and breeds of livestock. Yet another aspect is the variety of ecosystems such as those that occur in deserts, forests, wetlands, mountains, lakes, rivers and agricultural landscapes. It is the combination of life forms and their interactions with each other and with the rest of the environment that has made Earth a uniquely habitable place for humans.

We are changing life on Earth

Protecting biodiversity is in our self-interest. Nature's products support such diverse industries as agriculture, cosmetics, pharmaceuticals, pulp and paper, horticulture, construction and waste treatment. The loss of biodiversity threatens our food supplies, opportunities for recreation and tourism, and sources of wood, medicines and energy. It also interferes with essential ecological functions.

Just consider the many goods and services provided by ecosystems:

- Provision of food, fuel, fibre and shelter and building materials.
- Purification of air and water, detoxification and decomposition of wastes.
- Stabilization and moderation of the Earth's climate.

- Moderation of floods, droughts, temperature extremes and the forces of wind.
- Generation and renewal of soil fertility, including nutrient cycling.
- Pollination of plants, including many crops; control of pests and diseases.
- Maintenance of genetic resources as key inputs to crop varieties and livestock breeds and medicines.
- Cultural and aesthetic benefits.

While the loss of such charismatic animals as pandas, tigers, elephants, rhinos, whales and various species of birds catches our attention, it is the fragmentation, degradation and outright loss of forests, wetlands, coral reefs and other ecosystems that poses the gravest threat to biological diversity.

Our cultural identity is also deeply rooted in our biological environment. Plants and animals are symbols of our world, preserved in flags, sculptures and other images that define us. We draw inspiration just from looking at nature's beauty and power.

While loss of species has always occurred as a natural phenomenon, the pace of extinction has accelerated dramatically as a result of human activity. We are creating the greatest extinction crisis since the natural disaster that wiped out the dinosaurs 65 million years ago. These extinctions are irreversible and, given our dependence on food crops, medicines and other biological resources, pose a threat to our own well-being.

An Agreement for Action

While concern for the environment is constant in history, heightened concern about environmental destruction and loss of species and ecosystems in the 1970s led to concerted international action. In 1972, the United Nations Conference on the Human Environment (Stockholm) led to the establishment of the United Nations Environment Programme (UNEP). In the following years, Governments, often under UNEP auspices, signed a number of regional and international agreements to tackle specific issues, such as protecting wetlands and migratory species and regulating the international trade in endangered species.

Twenty years later, in 1992, the largest-ever meeting of world leaders took place at the United Nations Conference on Environment and Development in Rio de Janeiro, Brazil. An historic set of agreements was signed at the "Earth Summit", including two binding agreements, the Convention on Climate Change, which targets industrial and other emissions of greenhouse gases such as carbon dioxide, and the Convention on Biological Diversity, the first global agreement on the conservation and sustainable use of biological diversity. Over 150 Governments signed the treaty at the Rio Conference, and since then more than 175 countries have ratified it.

The Convention has three main goals:

- the conservation of biodiversity;
- sustainable use of the components of biodiversity; and
- sharing the benefits arising from the commercial and other utilization of genetic resources in a fair and equitable way.

The Convention recognizes – for the first time – that the conservation of biological diversity is "a common concern of humankind" and is an integral part of the development process. It also covers the rapidly expanding field of biotechnology, addressing technology development and transfer, benefit sharing and biosafety. The Convention also offers decision-makers guidance based on the precautionary principle that where there is a threat of significant reduction or loss of biological diversity, lack of full scientific certainty should not be used as a reason for postponing measures to avoid or minimize such a threat.

Some of the many issues dealt with under the Convention include:

- Measures and incentives for the conservation and sustainable use of biological diversity.
- Regulated access to genetic resources.
- Access to and transfer of technology, including biotechnology.
- Technical and scientific cooperation.
- Impact assessment.
- Education and public awareness.
- Provision of financial resources.
- National reporting on efforts to implement treaty commitments.

National Action

The Convention on Biological Diversity, as an international treaty, identifies a common problem, sets overall goals and policies and general obligations, and organizes technical and financial cooperation. However, the responsibility for achieving its goals rests largely with the countries themselves. At the national level, private companies, landowners, fishermen and farmers take most of the actions that affect biodiversity. Governments need to provide the critical role of leadership, particularly by setting rules that guide the use of natural resources, and by protecting biodiversity where they have direct control over the land and water.

Under the Convention, Governments are required to develop national biodiversity strategies and action plans, and to integrate these into broader national plans for environment and development. This is particularly important for such sectors as forestry, agriculture, fisheries, energy, transportation and urban planning.

Other treaty commitments include:

- Identifying and monitoring the important components of biodiversity that needs to be conserved and used sustainably.
- Establishing protected areas to conserve biodiversity while promoting environmentally sound development around these areas.
- Rehabilitating and restoring degraded ecosystems and promoting the recovery of threatened species in collaboration with local residents.
- Respecting, preserving and maintaining traditional knowledge of the sustainable use of biological diversity with the involvement of indigenous peoples and local communities.
- Preventing the introduction of, controlling and eradicating alien species that could threaten ecosystems, habitats or species.
- Controlling the risks posed by organisms modified by biotechnology.
- Promoting public participation, and educating people and raising awareness about the importance of biological diversity and the need to conserve it.
- Reporting on how each country is meeting its biodiversity goals.

Taking action

The conservation of each country's biodiversity can be achieved in various ways. "In-situ" conservation – the primary means of conservation – focuses on conserving genes, species and ecosystems in their natural surroundings, for example by establishing protected areas, rehabilitating degraded ecosystems, and

adopting legislation to protect threatened species. "Ex- situ" conservation uses zoos, botanical gardens and gene banks to conserve species. There are many examples of country-level initiatives to integrate the objectives of conservation and sustainable use:

- In 1994, Uganda adopted a programme under which protected wildlife areas shared part of their tourism revenues with local people -- an approach now being used in several African countries.
- Costa Rica's 1996 Forestry Law includes provisions to compensate private landowners and forest managers who maintain or increase the area of forest within their properties.
- Through weekly "farmer field schools", some 2 million rice farmers in several Asian countries have enhanced their understanding of the tropical rice ecosystem – including the interactions between insect pests of rice, their natural enemies, fish farmed in the rice paddies, and the crop itself – in order to improve their crop management practices. As a result, they have increased their crop yields, while at the same time almost eliminating insecticide use.
- Clayoquot Sound on the western coast of Vancouver Island, Canada, encompasses forests and marine and coastal systems. The establishment of adaptive management to implement the ecosystem approach at the local level is currently under development with the involvement of indigenous communities, with a view to ensuring rational use of the forest and marine resources.

The Convention's success depends on the combined efforts of the world's nations. The responsibility to implement the Convention lies with the individual countries and, to a large extent, compliance will depend on informed self-interest and peer pressure from other countries and from public opinion. The Convention Secretariat in Montreal regularly organizes global and regional meetings – where Governments, nongovernmental organizations, the academic and scientific communities, the private sector and other interested groups or individuals share ideas and compare strategies.

Sharing the benefits of genetic resources

An important part of the biodiversity debate involves access to and sharing of the benefits arising out of the commercial and other use of genetic material, such as pharmaceutical products. The treaty recognizes a country's sovereignty over its genetic resources, and provides that access to valuable biological resources be carried out on "mutually agreed terms" and subject to the "prior informed consent" of the country of origin. When a micro-organism, plant or animal is used for a commercial application, the country from which it came has the right to benefit through cash, samples of what is collected, the participation or training of national researchers, the transfer of biotechnology equipment and know-how, and shares of any profits. Work has begun to translate this concept into reality and there are already examples of benefit-sharing arrangements, such as:

- In 1995, the Philippines required bio-prospectors to get "prior informed consent" from both the Government and local peoples.
- Costa Rica's National Institute of Biodiversity (INBIO) signed a historic bio-prospecting agreement with a major drug company to receive funds and share in benefits from biological materials that are commercialized.

The Biosafety Protocol

Since the domestication of the first crops and farm animals, we have altered their genetic makeup through selective breeding and cross-fertilization. The results have been greater agricultural productivity and improved human nutrition.

In recent years, advances in biotechnology techniques have enabled us to cross the species barrier by transferring genes from one species to another. We now have transgenic plants, such as tomatoes and strawberries that have been modified to protect the plants from frost. Some varieties of potato and corn have received genes from a bacterium that enables them to produce their own insecticide. Other plants have been modified to tolerate herbicides sprayed to kill weeds. Living Modified Organisms (LMOs) are becoming part of an increasing number of products, including foods and food additives, beverages, drugs, adhesives, and fuels. Agricultural and pharmaceutical LMOs have rapidly become a multi-billion-dollar global industry.

Biotechnology is being promoted as a better way to grow crops and produce medicines, but it has raised concerns about potential side effects on human health and the environment. In some countries, genetically altered agricultural products have been sold without much debate, while in others, there have been vocal protests against their use, particularly when they are sold without being identified as genetically modified.

In response to these concerns, Governments negotiated a subsidiary agreement to the Convention to address the potential risks posed by cross-border trade and accidental releases of LMOs. Adopted in January 2000, the Cartagena Protocol on Biosafety allows Governments to signal whether or not they are willing to accept imports of agricultural commodities that include LMOs by communicating their decision to the world community via a Biosafety Clearing House, a mechanism set up to facilitate the exchange of information on, and experience with, LMOs. In addition, commodities that may contain LMOs are to be clearly labelled as such when being exported.

Exporters must also provide detailed information to each importing country in advance of the first shipment of seeds, live fish and other LMOs that are to be intentionally introduced into the environment, and the importer must then authorize the shipment. The aim is to ensure that recipient countries have both the opportunity and the capacity to assess any risks involving the products of modern biotechnology. The Protocol will enter into force after it has been ratified by 50 Governments.

Secretary-General Kofi Annan, in his *Millennium Report* has proposed convening a high-level global policy network to address these and related controversies concerning the risks and opportunities associated with the increased use of biotechnology and bioengineering.

A new initiative for assessing ecosystems

During the past three decades we have become increasingly aware that the natural ecosystems on which human life depends are under threat. But we still lack detailed knowledge of the extent of the damage – or its causes. Secretary-General Kofi Annan, in his *Millennium Report*, has underscored the need to develop a truly comprehensive global evaluation of the condition of the five major ecosystems: forests, freshwater systems, grasslands, coastal areas and agroecosystems. This proposed the Millennium Ecosystem Assessment seeks to produce just such an evaluation.

An initiative of the World Resources Institute, the World Bank, the United Nations Development Programme and the United Nations Environment Programme, among others, will draw on and collate existing sources of data and promote new research to fill the missing knowledge gaps.

The Secretary-General has called on the Member States to help provide the necessary financial support for the Millennium Ecosystem Assessment and to become actively engaged in it. Both developed and developing country Governments will benefit from the research work. The private sector will also benefit by being able to make more informed forecasts. And it will provide civil society with the information they need to hold corporations and Governments accountable for meeting their environmental obligations.

Joining hands

While Governments should play a leadership role, other parts of society need to be actively involved. After all, it is the choices and actions of billions of individuals that will determine whether or not biodiversity is conserved and used sustainably.

In an era when economics is a dominant force in world affairs, it is more important than ever to have business willingly involved in environmental protection and the sustainable use of nature. Fortunately, a growing number of companies have found ways to make a profit while reducing their environmental impacts, thus increasing goodwill from their business partners, employees and consumers.

Local communities play a key role since they are the true "managers" of the ecosystems in which they live. Many projects have been successfully developed in recent years involving the participation of local and indigenous communities in the sustainable management of biodiversity.

Finally, the ultimate decision-maker for biodiversity is the **individual citizen**. The small choices that individuals make add up to a large impact because it is personal consumption that drives development, which in turn uses and pollutes nature. By carefully choosing the products they buy and the government policies that they support, the general public can begin to steer the world towards sustainable development. Governments, companies and others have a responsibility to lead and inform the public, but, finally, it is individual choices, made billions of times a day, that count the most.

On a practical level, one can join others in:

1. Beautifying school grounds and parks, using local plant species.
2. Reclaiming abandoned lots into community gardens; adopting a local park.
3. Educating one another about local species of animals and plants.
4. Forming wildlife and gardening organizations, or joining existing ones.

UN Briefing Paper on Poverty

Overview

"I call on the international community at the highest level ... to adopt the target of halving the proportion of people living in extreme poverty, and so lifting more than 1 billion people out of it, by 2015."

Secretary-General Kofi Annan in the *Millennium Report*

Vital Statistics

- More than 2.8 billion people, close to half the world's population, live on less than the equivalent of \$2/day. More than 1.2 billion people, or about 20 per cent of the world population, live on less than the equivalent of \$1/day.
- South Asia has the largest number of poor people (522 million of whom live on less than the equivalent of \$1/day). Sub-Saharan Africa has the highest proportion of people who are poor, with poverty affecting 46.3 per cent or close to half of the regions' population.
- Nearly 1 billion people are illiterate; more than 1 billion people do not have access to safe water; some 840 million people go hungry or face food insecurity; about one-third of all children under five suffer from malnutrition.
- The estimated cost of providing universal access to basic social services and transfers to alleviate income poverty is \$80 billion, which is less than 0.5 per cent of global income.
- The top fifth (20 per cent) of the world's people who live in the highest income countries have access to 86 per cent of world gross domestic product (GDP). The bottom fifth, in the poorest countries, has about one per cent.
- The assets of the world's three richest men exceed the combined Gross Domestic Products of the world's 48 poorest countries.

The poverty trap

Until recently, poverty was understood largely in terms of income—or a lack of one. To be poor meant that one could not afford the cost of providing a proper diet or home. But poverty is about more than a shortfall in income or calorie intake. It is about the denial of opportunities and choices that are widely regarded as essential to lead a long, healthy, creative life and to enjoy a decent standard of living, freedom, dignity, self-esteem and the respect of others.

People don't live in the squalor of the slums, squatter communities, low-rent districts or beside garbage dumps because they want to. They have no other choice. Possessing little money, little education, few skills for the marketplace and a multitude of health problems, nearly half of all the people in the world live in poverty, without much opportunity to improve their lives.

Poverty has multiple dimensions, and many of them are inter-related, making for a vicious cycle:

- Poor health, disease and disability can prevent people from working full time, limiting their income and their ability to work to move out of poverty. Health problems for the breadwinner mean income problems, but an illness in the family can ruin an entire household. Not only is income lost, but expenses go up due to the need for medicines and health care and the need for family members to care for the sick person.
- Those with less formal education tend to be disproportionately represented in the ranks of the poor, perhaps because they are more likely to hold poorly paid jobs or to be unemployed. Poor families often

face enormous difficulties in keeping their children in school due to the costs, as well as to the pressure to have as many household members, including children, out working. The next generation, being poorly educated, could in turn end up holding similar poorly paid jobs.

- Women with children constitute the majority of the poor in many countries. Where women can move out of poverty their children appear to face a brighter future, but where their chances are limited, poverty is transmitted inter-generationally. In many cases, girls have higher dropout rates as they are the first to be pulled out of school to help with household work and childcare. Yet, experience has shown that investment in girls' and women's education not only makes for greater equity but also tends to translate directly into better nutrition for the family, better health care, declining fertility and potentially greater economic empowerment.
- Poverty has been identified as a major factor in the spread of HIV/AIDS in many parts of Africa. From simply being a cause of individual suffering, HIV/AIDS has become a major economic and social crisis for entire economies, as it affects the economically productive sections of society and makes it harder to eradicate poverty. It is estimated that at the end of 1999, nearly 34 million people worldwide were infected with HIV and by that by 2010 in Africa alone there will be 40 million orphans from the epidemic.
- As United Nations Secretary General Kofi Annan points out in his *Millennium Report*, "poor countries -- especially those with significant inequality between ethnic and religious communities -- are far more likely to be embroiled in conflicts than rich ones." In fact, twenty of the world's 38 poorest countries are either in the middle of an armed conflict or have recently emerged from it, according to other UN sources.

The roots of poverty

Poverty exists in many of the industrialized countries and characterizes whole regions of the developing world. The roots of poverty lie in a tangled web of local situations combined with national and international circumstances. It is the product of economic processes occurring at a variety of levels, as well as a range of particular social and economic conditions that appear to structure the possibilities of the individual.

Consider the following:

Some countries have to pay more to finance their debt than they can spend on health and education:

An obligation to repay debt incurred by past regimes—sometimes due to bad advice from developed countries, sometimes due to corrupt regimes—has severely curtailed the ability of many countries' efforts to break the poverty cycle. Sub-Saharan Africa pays over 14 per cent of export revenue in debt service. South Asia, another very poor region, pays 22 per cent. The Latin American and the Caribbean region must devote almost one-third of its export revenue to debt servicing.

- In recent years, Tanzania's debt service payments have been nine times its expenditure on primary health care, and four times as much as that spent on primary education.
- The value of Honduras's debt is 208 per cent of its exports; its debt service accounts for 55 per cent of Government expenditures.

In 1999, the IMF and the World Bank adopted the Enhanced Heavily Indebted Poor Countries Initiative, aimed at providing debt relief to 41 heavily indebted poor countries (HIPC). The plan is expected to relieve up to 70 per cent of the approximately \$170 billion debt that these countries owe. But so far, few countries have been able to qualify for relief and debt servicing has not always been sustainable. i.e. even after debt relief, the cost of servicing the debt has been greater than the amount spent on basic health and education, leave alone allowing for increased investment levels necessary for economic growth.

Trade-related factors and structural adjustment policies have had unfavourable effects: Many developing countries must rely on exporting unprocessed agricultural commodities to earn income overseas, but the prices of these agricultural products have been relatively unfavourable and have continued to fall. At the same time, world market prices for fuel and for manufactured and processed goods have risen. Furthermore, many

developed countries have imposed steep trade restrictions on agricultural products from developing countries, making it harder for them to sell their goods. With depressed earnings, many countries have been unable to break out of the poverty cycle through a focus on exports. At the same time, depressed export prices but a rising import bill made for balance of payment problems, a rise in borrowing and in the current context, higher debt levels. Some estimates of the loss on account of declining prices in the year 1992, find it to be higher than the total aid budget of the OECD for that year (\$65 billion compared to \$58 billion). The situation was often compounded by structural adjustment policies which encouraged depreciation of the currencies.

- Indonesia, once self sufficient in food, more recently had come to depend on imported food – 20 million tonnes of rice a year. This had disastrous consequences in the late 1990s, when in the wake of the Asian crisis, the currency was severely devalued (500%) and local conditions made for inadequate supplies of domestically produced food. The price of imported rice skyrocketed and according to one estimate, more than 100 million Indonesians joined the ranks of the poor as a consequence.

Owning few assets, the poor have little access to capital or credit: In many countries, a majority depend upon agriculture and inadequate access to land is one of the primary causes of rural poverty. Most of the world's poor either own no land or own land not worth owning. The land they live on is generally of poor quality for farming, and often subject to damage from storms and other natural disasters. Or they are subject to century-old land-owning systems that perpetuate an almost feudal-like system of land tenure, such as in the *hacienda* system in the Philippines. Caught in a trap between marginal incomes and little chance to obtain funds for improvements, there is little opportunity for advancement. Land reforms, public investment in rural infrastructure, technology and marketing services along with increased credit and price stability are necessary to remove the multiple constraints restricting the possibilities of the rural poor.

Lack of sufficient employment opportunities: Escaping the poverty of the rural areas, many people head toward the cities – in their own and in foreign countries -- to find a job. But in most countries, there aren't enough decent jobs—the kind that pays a living wage—to go around. Poor people then tend to try to eke out a living at the margins—in what has become known as the informal sector. The pressure on this sector is heightened with labour displacing technical change, declining growth of the economy and formal sectors, and by budget cuts. However, people in the informal sector barely scrape by, and enjoy little or no social protection. Globally, it is estimated that of a workforce of a three billion people, 140 million are unemployed, and between a quarter and a third are underemployed.

Inadequate infrastructure and lack of access to basic social services in relation to education, health and reproductive health: Often living in areas that have no sewage or clean water, poor people are much more susceptible to illness and disease. They also often lack the means to obtain the health care they need. At the same time, people living in poorer areas lack information on health and reproductive health issues, and consequently, are often uninformed on measures they can take to avoid risks.

Social exclusion: There are biases and prejudices in every country, and in some cases policies that exclude people of a certain race, religion, or sex from attaining positions of power or from getting good jobs. Often the bias has no basis in the law but is active nevertheless as in the case of gender discrimination or marginalisation of indigenous peoples. In such cases, affirmative action policies may need to be adopted for a period of time to improve the conditions of the excluded and to make for more equitable access to job opportunities.

Re-defining poverty

In the early days of the UN, poverty was measured in terms of the ability to meet a minimum number of calories or to have a minimum level of income to satisfy needs (income poverty). A "poverty line" defined this minimum level and the poor constituted the actual number of people whose incomes or calorie intake is less than this. A commonly used measure for purposes of international comparisons of income poverty is the \$1 or \$2 per day measure (purchasing power equivalent to \$1 or \$2 in the United States in 1993). There have been changes in thinking as to how to measure poverty with attempts at incorporating some of its various dimensions, as well as its circular connections that we talked about earlier.

In the 1970s the International Labour Organization (ILO) broadened the focus, and poverty came to be seen as the inability to meet basic needs. In the 1980s and 90s, the concept underwent further change by considering non-monetary aspects such as isolation, powerlessness, vulnerability and lack of security, as well as an individual's capacity and capability to experience well being.

Inspired by the work of Amartya Sen, a world famous economist who won the Nobel Prize for Economics in 1999, the United Nations Development Programme (UNDP) introduced measures for progress and for deprivation that focus on poverty from a human development perspective. It now views poverty as a denial of choices and opportunities for living a tolerable life. The human poverty index (HPI) constructed for each country provides a country-by-country picture of deprivation in terms of longevity, education and economic factors. Considering poverty in a different way leads to new observations. For example, an elevated level of the United States population experiences acute "human poverty" despite its high average income levels.

A strategy to fight poverty

In programmes aimed at tackling poverty, specific goals have been created and efforts concentrated or focused on meeting those targeted goals. Through this approach there has been some progress in poverty reduction since 1970, although it has not been spread equally over the different parts of the world. Most of the decline in poverty took place in East Asia, notably in China. In developing countries, infant mortality was cut by more than 40% and adult illiteracy by 50%. A newborn baby can expect to live 10 years longer, and combined net primary and secondary school enrolment has increased by nearly 50%. But there have also been reversals over the last few years, and huge problems remain.

Based on the experience of the past years, there is now a growing consensus among national and international policy makers on what works and what does not in fighting poverty. Policies that are part of the successful poverty reduction package of different countries include the following:

Inclusive and broad-based economic growth: Economic growth is one of the most important factors in helping to reduce poverty, but it is not sufficient. The effectiveness of economic growth in reducing poverty depends upon the structure of growth, existing levels of inequality and on how the benefits of growth are distributed.

Inequality in income is a function of the distribution of economic assets (land, industrial and financial capital), and so-called "human capital" in the form of education and skills. Governments need to work on creating more equity in the distribution of income and assets.

The effectiveness of growth in reducing poverty also depends on the extent of growth and employment opportunities created, and whether it takes place in areas and sectors where the poor are located. In most cases, with the exception of the South East Asian countries (Republic of Korea, Taiwan Province of China, Malaysia, etc.) in their high growth phase, there has not been sufficient employment generation in the formal sector of the economy. Attention now needs to be paid to the informal sector of the economy.

- According to the Secretary-General's *Millennium Report*, a 1 per cent increase in a country's gross domestic product can bring about an increase in the incomes of the poorest 20 per cent of the population. But this cannot happen where inequalities in society do not permit growth to benefit the poor.
- China is an example of what could be achieved by rapid economic growth built on investment in people: the gap in average income between China and the rest of the world has decreased by over 50 % compared to 40 years ago.

However, prospects for growth in the world economy currently are rather bleak. The world economy appears to be growing too slowly to create enough jobs or to make a real impact on poverty. Even the industrialized countries appear to be stuck with high unemployment, a major cause of poverty. This suggests that economies cannot rely on growth to pull them out of poverty, but must take specific steps to target poverty reduction directly.

Growth, if it is achieved at the cost of environmental degradation, can also undermine the livelihoods of the poor who are dependent upon these resources. Hence, development policies need to be sensitive to the social and economic environments of the poor.

- After the 1992 Earth Summit (Rio de Janeiro, Brazil), the Philippines was the first country to establish a council for sustainable development with partners from Government, civil society and private business. Key businesses worked to implement sustainable development initiatives – reusing by-products, controlling pollution levels and including environmental provisions in collective bargaining agreements with labour unions.

Realizing Globalization's Potential: The phenomenon of large corporations operating in many countries, in the hands of private individuals who make decisions about opening/closing and reorganizing operations that affect the lives of many people, is a reality of this new millennium. The process called globalization and increased economic integration offer countries many positive market and employment opportunities. But there are also risks and problems associated with it. The poor in poor countries at this time are often victims of this process. (See *Briefing Paper on Globalization* for a more comprehensive discussion of its pros and cons.) Countries need to prepare themselves for globalization by:

- building up the competitive advantage of their industries.
- addressing the problems of those who will lose out from global competition; and
- improving technology and increasing productivity so as to avoid competing on the basis of low wages, poorly regulated working conditions and exploitation of the environment.

Even after they have done all this, nothing is guaranteed. Markets may be saturated and despite globalization, many industrialized countries also still protect their markets with tariffs and quotas and discriminate against the products of developing countries. Better trade policies, fairer rules and terms that allow poor countries to enter developed country markets need to be put in place. The United Nations Secretary-General has urged all industrialized countries to consider granting duty-free and quota-free access for essentially all exports from the least developed countries. Governments and international agencies also need to work on preparing countries assisting them in developing regulatory policies that will soften the negative impact of volatile financial flows.

Promoting good governance, accountability and participation: Honest and fair government practices, free of corruption; decision making open to the input of the public; and follow-up actions in accordance with decisions made, are measures needed to eradicate poverty. Of prime importance are:

- good governance - the conduct of a government that is honest and fair; see briefing on governance
- transparency :- decision making can be open to public input and scrutiny; and
- accountability - ensuring that follow-up actions are in accordance with decisions openly arrived at, and that they can help ensure that the benefits of growth and poverty reduction policies actually reach the poor.

Key in bringing this about is the role that civil society can play, as is the process of allowing and encouraging the participation of the poor themselves in the making of policies, especially those that affect them directly. There is a clear link between empowering the poor and overcoming poverty. According to the UNDP Poverty Report 2000:

- In Andhra Pradesh, India, women organized themselves into self-help groups (SHG), which mobilized community savings, created opportunities for income generation for women via the increased access to credit and through a focus on skill formation and improved the status of women. The groups mobilized the community to make recommendations about loan priorities, and also tried to reduce or eliminate child labor and improve the condition of girls.

- Similarly, in Cambodia, local communities developed their own anti-poverty projects. Villagers brainstormed about their problems, they asked questions of officials and expressed their opinions about how best to do things.
- In Bulgaria, self-governing civic organizations increasingly provided vocational training, fostering new businesses, protecting the environment and resolving conflicts.

Provision of basic services and budgetary policies: The way in which public resources are mobilized and spent determines the kind of impact that it has on poverty. A fair and equitable public budgetary policy (relating to expenditure, taxation and government fiscal priorities) can also help to promote economic growth, reduce inequality and make development more pro-poor. Examples of success in pro-poor and participatory budgetary policies can be found in India, Brazil and Uganda.

Bringing about improvements in the quality of life, or reducing the level of deprivation, is a function not only of the resources available but also of the economic and social priorities and policies of government. Reducing the impact of the various dimensions of poverty is possible, even at low levels of income. Government spending on health and education, in combination with other policies that promote equitable growth, is particularly important in addressing poverty. Such social provisioning policies can help:

- reduce the experience of deprivation and poverty;
- increase peoples' productive capacities and possibilities; and
- reduce the amount that government must spend on dealing with the impacts of health or other crises and deprivation.

Countries such as Costa Rica, Cuba, Sri Lanka and Viet Nam and the state of Kerala in India have secured better health conditions, greater reductions in mortality and improvements in literacy over others with similar or greater economic resources. Viet Nam, with a per capita income of \$350, has a lower infant mortality (31 as compared to 60 per 1,000 live births) and higher adult literacy (92.9% as compared to 84.6%) than South Africa, which has a per-capita income of \$3,310.

Mauritius, a small island nation in the Indian Ocean cut its military budget and invested heavily in health and education. Today, all Mauritians have access to sanitation, 98 per cent to safe water and 97 per cent of births are attended by skilled health staff.

Achieving Gender Equity: More women than men live in absolute poverty. Economic crises have often hit them harder. Few of them tend to get fewer skilled jobs, and in situations of growing unemployment they are often the first to lose their jobs. This increases their vulnerability and makes them more susceptible to falling into poverty, a phenomenon referred to as the feminization of poverty.

Yet, as mentioned earlier, experience has shown that investment in girls' and women's education translates directly into better nutrition for the family, better health care and declining fertility. It has also been widely acknowledged that poverty is unlikely to be overcome without specific immediate and sustained attention to girls' education and women's empowerment. According to one estimate, closing the gender gap in education adds 0.5 percentage points to annual growth in GNP per capita.

National and International targets for poverty reduction: Throughout the 1990s, a series of international conferences on global development issues was held, with the eradication of poverty as a central goal. The World Summit for Social Development in 1995 expanded the context of poverty eradication to include such factors as:

- access to basic services
- productive employment
- sustainable livelihoods

- sense of human security
- reduction of inequalities
- elimination of discrimination
- participation in the life of the community.

At the summit, 117 nations pledged that their countries would take steps to eradicate poverty. Following the summit, countries were expected to establish national targets and policies to eradicate poverty.

The five-year follow-up review conference in Geneva in June 2000 recognized that "Since the Summit, globalization has presented new challenges for the fulfillment of the commitments made and the realization of the goals of the Summit ... The growing interdependence of nations, which has caused economic shocks to be transmitted across national borders, as well as increased inequality, highlights weaknesses in current international and national institutional arrangements and economic and social policies, and reinforces the importance of strengthening them through appropriate reforms."

As of now, it appears that with the slow growth in the world economy, and with countries struggling to revive economic growth, there is no prospect for their reaching their poverty targets any time soon.

Targets for a new millennium: In his Millennium Report, Secretary-General Kofi Annan lists ensuring freedom from want as the top-most priority facing humanity today. "We must spare no effort to free our fellow men and women from the abject and dehumanizing poverty," he declares. In the report, he identifies the following seven goals:

- halving the proportion of people living on less than a dollar a day;
- halving the proportion of people who suffer from hunger;
- halving the proportion of people who are unable to obtain safe drinking water;
- providing primary education to all girls and boys on an equal basis;
- halting—or even reversing—the spread of HIV/AIDS and the scourge of malaria;
- reducing maternal mortality by three-quarters and child mortality by two-thirds; and
- improvement in the lives of at least 100 million slum dwellers.

But how are such goals to be achieved?

The Secretary-General proposes very specific actions that affluent Governments should undertake:

- Grant free access to their markets for goods produced in poorer countries;
- Write off foreign debts;
- Grant more generous development assistance; and
- Work with pharmaceutical companies to develop an effective and affordable vaccine against HIV.

THIS PAGE INTENTIONALLY LEFT BLANK

UN Briefing Paper on Human rights

Overview

"As Secretary General I have made human rights a priority in every programme the United Nations launches and in every mission we embark upon. I have done so because the promotion and defence of human rights is at the heart of every aspect of our work and every article of our Charter. Above all, I believe human rights are at the core of our sacred bond with the peoples of the United Nations.

Kofi Annan, "The Question of Intervention," 1999

Vital Statistics

- The Universal Declaration of Human Rights, adopted unanimously in 1948 and translated into over 300 national and local languages, is the best known and most cited human rights document in the world.
- More than 80 international human rights instruments have been created since then.
- The office of the High Commissioner for Human Rights, the UN official with principal responsibility for human rights activities, receives reports of over 200,000 violations per year.
- A statute creating an International Criminal Court was adopted. Over 100 Member States signed it.
- The Office of the High Commissioner for Human Rights has set up a fax hot line for receiving complaints of violations of human rights. The fax number in Geneva is 41-22-917-9018.

A small step...

There are some 200,000 Guarani Indians living in Bolivia, Argentina, Brazil and Paraguay. For many years, schools in these countries taught only in Spanish and did not allow the use of Indian languages. Guarani children were unable to cope with the new language and lagged behind. Many thought they were stupid and backward. Then in 1989, two United Nations agencies, UNICEF and UNESCO, started a new school programme for the Guarani children, allowing them to learn two languages, Spanish and Guarani.

The initiative soon paid off. Guarani children began getting higher grades in all subjects. As a result, fewer children left schools before finishing. Thanks to the United Nations, the Guarani Indians will no longer be punished for speaking their own language.

...toward a giant leap

Now, more than a decade later, the world's indigenous peoples, including the American Indians, have won another significant recognition. For the first time, the United Nations has established a permanent forum to discuss issues important to the indigenous peoples. This forum, which will be a sub-group of the UN's Economic and Social Council, will deal with human rights, environmental, educational and development issues affecting indigenous people around the world.

"It is an exhilarating, historic day," said a spokesman for the indigenous peoples. This was another important step for the United Nations in its quest for establishing universal recognition of all rights for all peoples, a principle enshrined in the Universal Declaration of Human Rights. The explanation and articulation of the rights defined by the Universal Declaration has now achieved virtually universal acceptance. Today the Universal Declaration, translated into over 300 national and local languages, is the best-known and most cited human rights document in the world. It has served as a model for numerous international treaties and declarations as well as the constitutions and laws of many countries. The Declaration has inspired more than 80 international human rights instruments, which together constitute a comprehensive system of legally binding treaties for the promotion and protection of human rights.

There is now international recognition that respect for human rights includes:

- the right of political choice;
- the freedom of association;
- the freedom of opinion and expression;
- the right to express and enjoy one's own culture;
- the right to be free from arbitrary arrest and detention;
- the right to an adequate standard of living, including health, housing and food;
- the right to be free; and
- the right to work.

During the past five and a half decades, the list of rights clarified and articulated by International Law has expanded dramatically to include new issues, such as the right to development, capital punishment, children in armed conflicts, compensation of victims, disability, discrimination based on HIV/AIDS, enforced or involuntary disappearances, environment, impunity, indigenous peoples, migrant workers, peacekeeping operations, sale of children, terrorism, human rights defenders, war crimes and many more.

But assuring human rights for all people remains a daunting challenge, especially given the impunity with which they continue to be violated in all parts of the world. In a survey conducted in 1999, the world's largest ever public opinion poll survey conducted by Gallup International, respondents showed widespread dissatisfaction with the level of respect for human rights. In one region, fewer than one in 10 citizens believed that human rights were being fully respected, while one-third believed they were not observed at all. Discrimination by race and gender were commonly expressed concerns.

The building blocks

The major advances in human rights and human development came after the horrors of the Second World War. The 1945 Charter of the United Nations, followed by the Universal Declaration of Human Rights in 1948, ushered in a new era of international commitment to human freedoms. Among other things, they:

- emphasized the universality of rights, centered on the equality of all people;
- recognized the realization of human rights as a collective goal of humanity;
- identified a comprehensive range of all rights -- civil, political, economic, social and cultural -- for all people;
- created an international system for promoting the realization of human rights with institutions to set standards, establish international laws and monitor performance (but without powers of enforcement); and
- established the State's accountability for its human rights obligations and commitments under international law.

Work on international human rights legislation continued. But polarized by the cold war, the rhetoric of human rights was often reduced to a weapon in official propaganda for geopolitical interests. The West emphasized civil and political rights, pointing the finger at socialist countries for denying these rights. The socialist (and many developing) countries emphasized economic and social rights, criticizing the richest Western countries for their failure to secure these rights for all citizens. In the 1960s this led to two separate covenants -- one for civil and political rights; the other for economic, social and cultural rights.

The 1980s brought a strong renewal of international interest and action, propelled by a surge of activity by civil society on issues of democracy, women's and children's rights, rights of indigenous peoples and other issues. The two most notable achievements in these areas were: the Convention on the Elimination of All Forms of Discrimination Against Women (1979) and the Convention on the Rights of the Child (1989). Another milestone was the adoption in 1984 of the Convention against Torture and Other Degrading Treatment or Punishment, which declared torture as an international crime.

In 1986 the Declaration on the Right to Development was adopted. And further strong commitments were made at the World Conference on Human Rights in Vienna in 1993. This was followed by the creation of the position of United Nations High Commissioner for Human Rights and the growing advocacy for rights internationally and nationally. The late 1990s and the turn of the millennium brought other exciting developments:

- The 1998 Rome Statute to establish the International Criminal Court opened up possibility for prosecuting those responsible for crimes against humanity. By April 2000 nearly 100 countries signed it.
- Establishment of the International Tribunals for former Yugoslavia (1993) and for Rwanda (1994) is helping enforce individual accountability for war crimes.
- The optional protocol to CEDAW (1999) has opened the way for individuals to submit claims of violations of women's rights.
- Two new Optional Protocols to the Convention on the Rights of the Child have strengthened the landmark 1989 treaty: one on child soldiers, the other on sale of children.
- Useful stock taking exercises regarding government programs in women's rights and social development was carried out in the Beijing+5 and Copenhagen+5 review conferences.
- The appointment of three new Special Rapporteurs -- on the right to adequate housing, the right to food and the issue of globalization and its impact on the full enjoyment of all human rights -- will help focus on the emerging human rights issues.

Principal human rights instruments

- **International Bill of rights:** The International Bill of Rights consists of the Universal Declaration of Human Rights (UDHR), the International Covenant on Civil and Political Rights (ICCPR) and its two optional protocols and the International Covenant on Economic, Social and Cultural Rights (ICESCR). UDHR is a Declaration adopted by the General Assembly and hence requires no ratification; ICCPR has been ratified by 144 countries and ICESCR by 142 countries.
- **International Convention on the Elimination of All Forms of Racial Discrimination:** Adopted in 1965 and entered into force in 1969, it deals with a particular kind of discrimination – that based on race, colour, descent or national ethnic origin. Ratification: 156 countries.
- **Convention on the Elimination of All Forms of Discrimination Against Women (CEDAW).** Adopted in 1979 and entered into force in 1981, this represents the first comprehensive, legally binding international instrument prohibiting discrimination against women and obligating Governments to take affirmative action to advance gender equality. Ratification: 165.
- **Convention Against Torture and Other Cruel, Inhuman and Degrading Treatment or Punishment.** Adopted in 1984 and entered into force in 1989, the Convention lays out the steps to be taken by Governments to prevent torture and other cruel or degrading treatment or punishment. Ratification: 119 countries.
- **Convention on the Rights of the Child.** Adopted in 1989 and entered into force in 1991, the Convention recognizes the need for specific attention to protecting and promoting the rights of children. Ratification: 191 countries.

How is compliance monitored once a country ratifies a Convention?

Within each of the six major human rights treaties there is a provision to set up a treaty body to monitor compliance. This treaty body examines report of States which have ratified the treaty. Each year they engage in dialogue with approximately 60 national Governments and issue concluding observations and suggestions by independent experts for improvement. Some of these bodies are:

- The Committee on the Elimination of Racial Discrimination
- The Committee on the Elimination of Discrimination against Women
- The Committee on the Rights of the Child
- The Committee against Torture
- The Human Rights Committee
- The Committee on Economic, Social and Cultural Rights

In addition, mechanisms have been set up beyond the Conventions to address special issues. Such mechanisms include the creation of:

- United Nations Special Rapporteurs
- Special Representatives of the Secretary-General
- Experts
- Working Groups

Human rights and human security

In the 1990s, the world witnessed some of the worst violations of human rights. In country after country, innocent civilians became targets of unprecedented terror, often led by armed groups who demonstrated scant regard for human life and human values. In some cases, the Governments were unable to protect their own civilians; in others, the Governments themselves took part in attacking civilians, especially minority ethnic groups. From Angola and Sierra Leone to Bosnia and Kosovo to East Timor, millions have been killed; over 30 million have been displaced; countless men, women and children have been denied some of the most fundamental human rights.

What should be done when faced with such humanitarian crises?

Secretary-General Kofi Annan says the United Nations – and the international community – cannot accept a situation where people are brutalized behind national boundaries. "A United Nations that will not stand up for human rights is a United Nations that cannot stand up for itself. We know where our mission for human rights begins and ends: with the individual and his or her universal and inalienable rights -- to speak, to act, to grow, to learn and to live according to his or her own conscience," he said.

To address the new humanitarian challenges, in a report to the Security Council submitted in September 1999, the Secretary-General proposed specific recommendations for consideration by the Member States, including:

- **Ratification and implementation of international instruments:** He urged Member States to ratify the major instruments of international humanitarian law, human rights law and refugee law, and to adhere to them.
- **Accountability for war crimes:** When Governments or groups fail to comply with such international humanitarian law, enforcement measures should be considered. He asked the Member States to ratify the Statute of the International Criminal Court.

- **Minimum age of recruitment in the armed forces:** He asked the Member States to support raising the minimum age for recruitment in the armed forces to 18.
- **Intervention in cases of systematic violations of international law:** He asked the Member States to consider appropriate enforcement action in the face of massive and ongoing abuses.

Human rights and development

"Poverty limits human freedoms and deprives a person of dignity," says the *2000 Human Development Report* published by the United Nations Development Programme (UNDP). This statement only re-emphasized what has already been clearly stated by the Universal Declaration of Human Rights (1948), the Declaration on the Right to Development (1986) and the Vienna Declaration adopted at the 1993 Human Rights Conference.

To quote the General Assembly Declaration on Development, "the human person is the central subject of the development process and ...development policy should therefore make the human being the main participant and beneficiary of development." Yet, at a time of unprecedented economic growth, more than a billion people live in abject poverty; almost 800 million people suffer from malnutrition, 140 million school age children do not go to school; and 900 million adults are illiterate. Of a total world labour force of some 3 billion, 140 million workers are out of work altogether, and a quarter to a third are underemployed.

One of the ways the United Nations has tried to respond to this need is by setting specific goals and working towards achieving them. In each of the major world conferences held in the 1990s, the United Nations set such goals and subsequently took stock of progress made. Based on the experience of the past years and through close collaboration with the Organization for Economic Cooperation and Development, the World Bank and the International Monetary Fund, the United Nations has now come up with seven specific goals to be achieved between the years 2000 and 2015. The goals, outlined in a report entitled "*2000: For a better world*," are as follows:

- Reduce the proportion of people living in extreme poverty by half;
- Enroll all children in primary school;
- Make progress towards gender equality and empowering women by eliminating gender disparities in primary and secondary education;
- Reduce infant and child mortality ratios by two-thirds;
- Reduce maternal mortality ratios by three-quarters;
- Provide access for all who need reproductive health services;
- Implement national strategies for sustainable development to reverse the loss of environmental resources.

In the words of Secretary-General Kofi Annan, the goals are not utopian. They are ambitious, but achievable. "To reach them, we will need to work hard."

Signs of progress

- The ratification of the Children's Rights Convention by nearly every country on earth since its adoption by the General Assembly in 1989 has made it the most ratified human rights treaty in history. Marked changes are occurring in its implementation. At least 22 countries have incorporated children's rights in their constitutions. More than 50 countries have a process of law review to ensure compatibility with the Convention's provisions. Parliaments in Brazil, South Africa and Sri Lanka have enacted legislation and national budgets to more clearly identify allocations for children. Such harmful traditional practice as genital mutilation is now banned in a number of West African states, including Burkina Faso and

Senegal. Corporal punishment of children in schools and in the family is prohibited in Austria, Cyprus and the Nordic countries.

- Two new Optional Protocols to the Children's Convention have been adopted. One is on the involvement of children in armed conflict. It raises from 15 to 18 years the age at which participation in armed conflicts will be permitted and establishes a ban on compulsory recruitment below 18 years. The second relates to the sale of children, child prostitution and child pornography. It gives special emphasis to the criminalization of serious violations of children's rights - namely sale of children, illegal adoption, child prostitution and pornography.
- CEDAW's new optional protocol allows individuals to claim remedies for violations of Convention rights.
- Non-governmental organizations can now submit "shadow reports" – alternative statements to supplement State submissions – to all human rights treaty bodies.
- The International Criminal Tribunal for Rwanda found Jean-Paul Akayesu guilty of the crime of genocide, making him the first person ever found guilty of the crime of genocide by an international tribunal.
- Efforts are under way to set up a tribunal to deal with crimes against humanity committed by Khmer Rouge in Cambodia. Secretary-General Kofi Annan has recommended that any such tribunal should have an international character.

Several major multinational corporations have joined with the United Nations in a "Global Compact", agreeing to respect fundamental human rights, labour rights and environmental norms everywhere, including in countries where such rights are not fully upheld.

The Seven Freedoms

In an important contribution to the rights-based approach to development, the *2000 Human Development Report*, prepared by the United Nations Development Programme, lists seven freedoms which all people have the right to enjoy:

- **Freedom from discrimination** - Women, racial and ethnic groups have suffered violent discrimination. While the struggles against deep prejudices have brought many gains in freedom, the war is not yet over for the billions still suffering from discrimination.
- **Freedom from want** - There is enough food, but distribution inequities still account for hunger and malnutrition. National and global economic systems have to honour obligations to those humiliated by want.
- **Freedom for personal development** - Fundamental changes are occurring in the communications and information industries, and at near lightening speed. The opportunities afforded for personal development through technological changes are enormous. But a digital divide still exists in the world. Information is different and must be accessible to those who need and want it. We are all impoverished if the poor are denied opportunities to make a living. And it is within our power to extend these opportunities to all.
- **Freedom from threats to personal security** - The frequency of torture in history provides a tragic indicator of the evil that lurks in the hearts of people. The elimination of torture, and the national and international prosecution of those who engage in it, are central to the continuing struggle for the freedom of personal security. And when rape is the issue, institutions and values that deny dignity and protection to women must be accountable.
- **Freedom for participation** - The global gains in democracy are still very recent. Active involvement in civic institutions and unprecedented access to information and knowledge by all will enhance fundamental political freedoms.

- **Freedom from injustice** - Securing this freedom will require institutions that protect people through transparent rules applied equally to all. Social institutions must be based on legitimacy, consent and rule of law.
- **Freedom for productive work** - Much has been achieved in protecting children and improving the working conditions of adults. Many enjoy this freedom but millions toil in inhumane conditions while others feel socially excluded by lack of work. Dignity demands a commitment to including the ostracized and abolishing oppressive working conditions.

THIS PAGE INTENTIONALLY LEFT BLANK



**COMMON TRAINING
PROFICIENCY LEVEL FIVE
INSTRUCTIONAL GUIDE**



SECTION 1

EO M502.01 – PERFORM 45 HOURS OF INDIVIDUAL COMMUNITY SERVICE

Total Time:

One session = 90 min

PREPARATION

PRE-LESSON INSTRUCTIONS

This IG supports EO M502.01 (Perform 45 Hour of Individual Community Service) located in A-CR-CCP-805/PG-001, *Royal Canadian Air Cadets Proficiency Level Five Qualification Standard and Plan*, Chapter 4.

Review the lesson content and become familiar with the material prior to delivering the lesson.

Gather the required resources:

- One copy of the case study “Flight Sergeant Kaye and Green Narrows Park” located at Annex A for each cadet,
- One copy of the Personal Inventory Handout located at Annex B for each cadet,
- One copy of the Investigation Plan handout located at Annex C for each cadet,
- One copy of the Community Service Checklist located at Annex E for each cadet,
- Pen / pencil and eraser for each cadet, and
- Whiteboard or flipchart and markers.

PRE-LESSON ASSIGNMENT

Nil.

APPROACH

An interactive lecture was chosen for TPs 1 and 2 to orient the cadets to the requirements of PO 502 (Perform Community Service), introduce cadets to the stages of service learning and generate interest.

A case study was chosen for TP 3 to illustrate the application of the community service model and to stimulate thought about the different options available under the model.

A practical activity was chosen for TPs 4 and 6 as it is an interactive way to introduce cadets to the first stages of service learning.

An in-class activity was chosen for TP 5 as it is an interactive way to stimulate thought on needs in the community and introduce cadets to ideas they may not have otherwise considered.

INTRODUCTION

REVIEW

Nil.

OBJECTIVES

By the end of this lesson the cadet shall have an understanding of the requirements for 502 PC (Perform Community Service) and the stages of service learning. They will also have begun the first stage of service learning, as required to complete PO 502 (Perform Community Service).

IMPORTANCE

It is important for cadets to perform community service as it contributes directly to supporting part of the aim of the Cadet Program—to develop attributes of good citizenship. Through completing the stages of service learning, cadets can ensure community service is meaningful and successful.

Teaching Point 1**Review the requirements of PO 502 (Perform Community Service).**

Time: 10 min

Method: Interactive Lecture

A requirement of Phase Five / Master Cadet / Proficiency Level Five is the completion of 45 hours of community service. These hours will be tracked by cadets in the Phase Five / Master Cadet / Proficiency Level Five logbook.

The 45 hours of community service shall not consist of activities that directly benefit the corps / squadron or the sponsor, such as fundraising. However, community service activities that the corps / squadron participates in (such as supporting the Royal Canadian Legion Poppy Campaign) may be used to satisfy the 45-hour requirement.

At least one community service activity must be completed using the “community service learning model,” a five-stage process that ensures that the community service has value, purpose, and meaning, offers learning experiences, and uses previously acquired skills and knowledge.

The model’s steps, which are explained thoroughly in the next TP, consist of:

- inventory and investigation,
- preparation and planning,
- action,
- reflection, and
- demonstration.

As part of the PC for PO 502 (Perform Community Service), cadets’ demonstrations of community service (the last stage of the model) will be evaluated. Cadets will showcase one or more community service activity and demonstrate one to three major learning outcomes from the community service.

CONFIRMATION OF TEACHING POINT 1**QUESTIONS:**

- Q1. How many hours of community service must cadets complete in order to successfully complete PO 502 (Perform Community Service)?
- Q2. Why will activities benefiting the corps / squadron not be counted towards the requirements of PO 502 (Perform Community Service)?
- Q3. What is the final stage of the service learning model and what must be done to successfully complete it?

ANTICIPATED ANSWERS:

- A1. 45 hours.
- A2. Cadet community service is intended to be outward focused, benefiting the community rather than the corps / squadron itself. Genuine community service is focused on improving the situation of the community, rather than one’s own situation.
- A3. Demonstration. Cadets must showcase one or more of their community service activities and demonstrate one to three learning outcomes from the service.

Teaching Point 2**Explain the five stages of service learning.**

Time: 20 min

Method: Interactive Lecture



Conduct the interactive lecture using a dynamic method that allows for the engagement of the cadets, such as:

- having the cadets review a handout covering the material, highlighting key points, marking a question mark beside points needing clarification, and making other notes as needed; or
- assigning a stage to each cadet, or pairs of cadets, to read and review and present to the other cadets.

STAGE 1: INVENTORY AND INVESTIGATION**Objective**

The aim of the first stage of service learning is to identify a genuine opportunity for meaningful community service.

Process

A genuine opportunity for meaningful community service is found by identifying a verified need in the community which appeals to the individual's interests and which their skills and knowledge will allow them to fill.

This stage is completed in two steps:

First, a personal inventory is created, identifying the skills, knowledge, and strengths of the volunteer. This simple list will serve as a tool to identify the optimal manner in which the individual can address a community need.

Second, a need in the community is identified. This may be done by:

- identifying an existing program or activity that is addressing a community need;
- observing a need in the community; and / or
- receiving a request from the community for assistance in meeting a need.

The volunteer then investigates the problem and validates the need. The observable need or issue is the manifestation or symptom of the problem. Where possible, the underlying problem should be the target of the community service rather than the visible need. For example, to address the need posed by litter in a park, the volunteer could arrange for the installation of additional garbage cans rather than organizing patrols. This would address the underlying problem, a lack of places to put garbage, rather than the observable issue (the presence of trash).



Even if a need is identified through a request from a community member or organization, an investigation is still conducted to document, authenticate, and understand the underlying problem behind the need.

Research methods that may be used to investigate underlying problems and validate needs include:

- examining the media, such as books, magazines, and newspapers;

- conducting interviews with people who have expertise in the subject matter;
- reviewing past experiences;
- observing relevant situations (eg, investigating homelessness by visiting a local shelter); and
- conducting a survey with people who may have knowledge about the subject matter.

When the investigation is completed, the volunteer will understand the extent of the need and have developed a baseline from which they may monitor progress.

STAGE 2: PREPARATION AND PLANNING

Objective

The aim of the second stage of the service learning process is to prepare the volunteer to complete the service by developing a plan.

Process

The volunteer completes a plan for performing the community service. The plan should draw upon the skills and knowledge identified during the inventory and directly address the need and problem found during the investigation. Collaboration with community organizations, such as government agencies and non-profit organizations, will almost definitely play a prominent role in the plan. If the plan involves multiple volunteers, roles and responsibilities for those involved must be identified. Finally, realistic parameters and objectives will be defined, working off the benchmarks identified in the first stage.

Developing the plan may involve more research using the methods discussed earlier or other methods.

STAGE 3: ACTION

Objective

In this stage, the community service is conducted.

Process

While conducting the community service, it is important that the volunteer monitor progress towards the objectives, conduct more research as needed and alter the plan as required.

STAGE 4: REFLECTION



Stage 4: Reflection may occur both during and after implementation of the community service activity. Reflection during the activity may reveal better ways to complete the community service or a new focus.

Objective

The aim of the fourth stage is to place the service learning experience in the context of the volunteer, the community, and the global community.

Process

Reflection is not simply a process for reviewing the events that have occurred. Rather, it is a method by which the volunteer examines the events within the context of themselves and the community.

Questions that may be answered through reflection include:

- What did I learn from this experience?
- What will I take away from this experience?
- How did I feel when conducting the service? Why?
- Five years from now, how will I remember this service?
- If I could share one message with the community as a result of this service activity, what would it be?
- What would I do differently?

To reflect, volunteers could complete:

- the four square reflection tool located at Annex D,
- a journal, blog, or video blog,
- an analysis of a “day in the life” of those benefiting from the service. How has it changed? How might they feel differently?
- a piece of art that represents the community service activity, or
- another activity that provides a structured avenue to viewing the community service.

STAGE 5: DEMONSTRATION

Objective

The aim of the final stage of the service learning model is to showcase what the volunteer has done and the effect it has had on the volunteer and the community.

Process

Examples of demonstrations include:

- a report to peers, staff, parents / community members,
- an article or letter to a local newspaper,
- a publication or website,
- a video or photo essay,
- a presentation or performance, and
- a public display of art.

Demonstrations share what the volunteer has discovered and learned and may inspire others to become involved.



Consider the volunteer at the beginning of the service learning process, in Stage 1: Inventory and Investigation or Stage 2: Preparation and Planning: a demonstration would be extremely helpful to them as they consider getting involved in the community.

By inspiring and informing other volunteers, demonstrations can leverage one individual's involvement into the involvement of many and contribute to building a culture of community service.

CONFIRMATION OF TEACHING POINT 2**QUESTIONS:**

- Q1. While conducting the community service, it is important to continually monitor progress and make modifications to the plan as necessary. What types of modifications to the plan might be made?
- Q2. Why create a personal inventory of interests, skills, and knowledge?
- Q3. Where might needs be observed in the community?
- Q4. What may be achieved through the demonstration phase?

ANTICIPATED ANSWERS:

- A1. Extension or shortening of timelines, modification of objectives, involvement of more or fewer volunteers, etc.
- A2. Meaningful service opportunities will put a person's skills to good use. Service will be more enjoyable if it aligns with skills and interests.
- A3. Daily life. The press. City council minutes. Academic reports.
- A4. Inform other individual's plans for community service. Inspire others to perform community service. Raise awareness for the need or issue.

Teaching Point 3**Have the cadets identify the stages of service learning in a case study.**

Time: 25 min

Method: Case Study

Have the cadets review the case study located at Annex A.

Conduct a discussion on the stages of the service learning model seen in the case study to identify alternative methods of completing the five stages.



TIPS FOR ANSWERING / FACILITATING DISCUSSION:

- Establish ground rules for discussion, eg, everyone should listen respectfully; don't interrupt; only one person speaks at a time; no one's ideas should be made fun of; you can disagree with ideas but not with the person; try to understand others as much as you hope they understand you; etc.
- Sit the group in a circle, making sure all cadets can be seen by everyone else.
- Ask questions that will provoke thought; in other words avoid questions with yes or no answers.
- Manage time by ensuring the cadets stay on topic.
- Listen and respond in a way that indicates you have heard and understood the cadet.
- This can be done by paraphrasing their ideas.
- Give the cadets time to respond to your questions.
- Ensure every cadet has an opportunity to participate. One option is to go around the group and have each cadet answer the question with a short answer. Cadets must also have the option to pass if they wish.
- Additional questions should be prepared ahead of time.

SUGGESTED QUESTIONS:

- Q1. How did FSgt Kaye find the underlying problem in Green Narrows? How else could she have researched it?
- Q2. How well did FSgt Kaye's plan reflect her interests, skills, and knowledge?
- Q3. Would you have conducted the community service differently? If so, how?
- Q4. How did FSgt Kaye reflect on her community service? How else could she have reflected?
- Q5. Do you think FSgt Kaye's method of demonstration was a good one? Why or why not?



Other questions and answers will develop throughout the group discussion. The group discussion should not be limited to only those suggested.



Reinforce those answers given and comments made during the group discussion, ensuring the teaching point has been covered.

CONFIRMATION OF TEACHING POINT 3

The cadets' participation in the group discussion will serve as the confirmation for this TP.

Teaching Point 4**Have the cadets complete a personal inventory of skills, talents, and interests.**

Time: 10 min

Method: Practical Activity

OBJECTIVE

The objective of this activity is to provide cadets with the opportunity to identify their skills, talents and interests, beginning the first stage of the service learning model.

RESOURCES

- A copy of the Personal Inventory handout located at Annex B for each cadet, and
- A pen or pencil and eraser for each cadet.

ACTIVITY LAYOUT

Quiet area with table space.

ACTIVITY INSTRUCTIONS

1. Distribute the Personal Inventory handout located at Annex B to each cadet.
2. Provide 10 minutes to complete.
3. Provide assistance as necessary.

SAFETY

Nil.

CONFIRMATION OF TEACHING POINT 4

The cadets' participation in the practical activity will serve as the confirmation for this TP.

Teaching Point 5**Have the cadets brainstorm needs in their community.**

Time: 10 min

Method: In-Class Activity

OBJECTIVE

The objective of the brainstorming activity is to stimulate thought about needs in the cadets' communities that they may address through community service.

RESOURCES

Whiteboard or flipchart and markers.

ACTIVITY LAYOUT

Classroom with seating arranged in a semi-circle.

ACTIVITY INSTRUCTIONS

1. Have cadets brainstorm different communities (eg, geographic, interest, and cultural) in their area and write them in a list.

2. Have cadets brainstorm different needs within those communities and write them in a list.

SAFETY

Nil.

CONFIRMATION OF TEACHING POINT 5

The cadets' participation in the in-class activity will serve as the confirmation for this TP.

Teaching Point 6

Have the cadets complete an initial plan for the investigation process.

Time: 15 min

Method: Practical Activity

OBJECTIVE

The objective of this activity is to provide cadets with the opportunity to create a plan for an investigative process, continuing the first stage of the service learning model.

RESOURCES

- A copy of the Investigation Plan handout located at Annex C for each cadet.
- A pen or pencil and eraser for each cadet.

ACTIVITY LAYOUT

Quiet area with table space.

ACTIVITY INSTRUCTIONS

1. Have the cadets select a need identified during TP 5 or another need.
2. Distribute the Investigation Plan handout located at Annex C to each cadet and have them develop a plan to research that need.
3. Provide 15 minutes to complete.
4. Provide assistance as necessary.

SAFETY

Nil.

CONFIRMATION OF TEACHING POINT 4

The cadets' participation in the in-class activity will serve as the confirmation for this TP.

END OF LESSON CONFIRMATION

QUESTIONS:

- Q1. What are the requirements for successfully completing PO 502 (Perform Community Service)?
- Q2. How is community service tracked?

Q3. What are the five stages of service learning? Are you required to use them for completing PO 502 (Perform Community Service)?

ANTICIPATED ANSWERS:

- A1. 45 hours of community service that may not directly benefit the corps / squadron or the sponsor. One community service activity must utilize the service learning model.
- A2. Through the logbook.
- A3. Inventory and Investigation, Preparation and Planning, Action, Reflection, and Demonstration. The stages must be used for at least one community service activity.

CONCLUSION

HOMEWORK / READING / PRACTICE

Nil.

METHOD OF EVALUATION

This EO is assessed IAW Chapter 3, Annex B, 502 PC.

CLOSING STATEMENT

The service learning model is designed to ensure a complete process whereby cadets participate in genuine, meaningful service.

INSTRUCTOR NOTES / REMARKS

Nil.

REFERENCES

Kaye, Cathryn B. *The Complete Guide to Service Learning: Proven, Practical Ways to Engage Students in Civic Responsibility, Academic Curriculum, & Social Action*. Minneapolis, MN: Free Spirit Publishing Inc, 2010.

THIS PAGE INTENTIONALLY LEFT BLANK

CASE STUDY: “FLIGHT SERGEANT KAYE AND GREEN NARROWS PARK”

On the way to her parade night, FSgt Kaye passes through Green Narrows Park. She always arrives at cadets a little bit annoyed. The path is littered with wrappers, cans, and chip bags left by students at the nearby school. While FSgt Kaye stops to pick up a few pieces of litter every night, it only makes a small dent in the look of the park. There’s always quite a few pieces left.

One night, after she arrived particularly frustrated, 2Lt Hailstone asked her what the matter was. After FSgt Kaye explained, 2Lt Hailstone left FSgt Kaye with a sympathetic nod. “Let me know if you want to do something about it, Flight Sergeant.”

FSgt Kaye considered 2Lt Hailstone’s suggestion. What could she do? She surveyed the scene around her: FSgt Kaye was a Flight Commander, a leader. She knew how to organize a team, motivate subordinates, and create a plan. A high school student, she was also a good researcher and writer.

One obvious question still needed to be answered: where was this litter coming from? FSgt Kaye decided to visit the park during her school’s lunch break to see if she could learn something new. Instead of finding a vacant park, like on her walks to the squadron, the park was filled with teenagers from the middle school across the street. She watched as students finished their lunches and made their way back to the school. When a boy dropped trash right beside her she couldn’t stop herself: “you dropped something!” she called out. “Ya, where else should I put it?” the student replied over his shoulder. As FSgt Kaye looked around, she realized that the student had a point. There were no garbage bins to be seen.

On the walk back to school, FSgt Kaye made a plan. Rather than lead her cadets in garbage sweeps of the park, she would tackle the underlying issue: the lack of garbage bins. Other parts of the city had garbage bins—perhaps this park was just missed. She would contact her city councilor. And, to make it easier on the city, she could offer her cadets’ help in installing the bins. She bounced the plan off OCdt Patterson, who agreed to edit the letter if FSgt Kaye liked.

A few weeks later, she heard back. The city had indeed forgotten to include garbage bins in its plan for the park. They would arrange for a few to be installed, if only she could suggest where they be placed. The next week she returned to the park with OCdt Patterson and a group of cadets. With the maps from the city in hand, the cadets got to work counting the trash, finding where most of it ended up, and noting the grid references for the best places for garbage bins.

A few weeks later 2Lt Hailstone noticed the difference in FSgt Kaye. Instead of inspecting uniforms with a frown, she was cheerfully greeting cadets as they came in the door. “How’s that park looking?” she asked.

“The park?”

“I was just wondering: you said it was your source of frustration but you seem to be in such a good mood this week.”

“Oh, that’s right! I guess I have been in a different mood lately. My project turned out great, the trash cans seem to be collecting everything and I got a nice note from the City’s planning department commending me and the cadets for the accuracy of the grid references and choices of location.”

“Good to hear, Flight Sergeant. I knew you would figure it out.”

FSgt Kaye saw one more opportunity to make a difference though. When Lt Daley asked for volunteers to put together static displays for the Annual Ceremonial Review, she quickly volunteered. She wanted other cadets to know how easy it was to effect change in their city.

THIS PAGE INTENTIONALLY LEFT BLANK

Personal Inventory

Interests: I like to learn and think about . . .

Skills and talents: I can . . .

Knowledge: I know . . .

THIS PAGE INTENTIONALLY LEFT BLANK

Investigation Plan

Use the questions in the following four categories as guides for planning how to find out more about a community need. Not all methods must be used.

Finding out about _____

MEDIA

What media (newspapers, TV stations, radio, etc.) in your community might have helpful information? List ways you can use different media to learn about this need in your community.

INTERVIEWS

Think of a person who is knowledgeable about this topic in your area—perhaps someone in a local organization or government office. Write four questions you would ask this person in an interview.

An interview with _____

Questions:

1.

2.

3.

4.

SURVEY

A survey can help you find out what people know or think about a topic and get ideas for helping.

Who could you survey—cadets, family members, neighbours? How many surveys would you want completed? Write three survey questions.

Who to survey:

How many surveys:

Questions for the survey:

1.

2.

3.

OBSERVATION AND EXPERIENCE

How can you gather information through your own observation and experience? Where would you go? What would you do there? How would you keep track of what you find out?

Four Square Reflection Tool

<p>What happened?</p>	<p>How do I feel?</p>
<p>Ideas?</p>	<p>Questions?</p>

THIS PAGE INTENTIONALLY LEFT BLANK

Community Service Checklist

Inventory and Investigation	Identify skills and interests	<input type="checkbox"/>
	Identify a community need to address	<input type="checkbox"/>
	Investigate the underlying problem	<input type="checkbox"/>
	Identify potential community partners	<input type="checkbox"/>
Preparation and Planning	Collaborate with community partners	<input type="checkbox"/>
	Define the goal of the community service	<input type="checkbox"/>
	Describe anticipated results	<input type="checkbox"/>
	Identify how to measure the effects of the community service	<input type="checkbox"/>
	Identify how progress will be monitored	<input type="checkbox"/>
	Define roles and responsibilities of all involved	<input type="checkbox"/>
	Create a timeline for all tasks	<input type="checkbox"/>
	Identify required resources	<input type="checkbox"/>
	Create a budget if required	<input type="checkbox"/>
Action	Monitor progress	<input type="checkbox"/>
Reflection	Describe what happened	<input type="checkbox"/>
	Examine the difference made	<input type="checkbox"/>
	Discuss thoughts and feelings	<input type="checkbox"/>
	Consider activity improvements	<input type="checkbox"/>
	Generate ideas and identify questions	<input type="checkbox"/>
	Receive feedback	<input type="checkbox"/>
Demonstration	Identify an audience	<input type="checkbox"/>
	Identify a time and place to do the demonstration	<input type="checkbox"/>
	Create a demonstration	<input type="checkbox"/>
	Execute the demonstration	<input type="checkbox"/>

THIS PAGE INTENTIONALLY LEFT BLANK



**COMMON TRAINING
PROFICIENCY LEVEL FIVE
INSTRUCTIONAL GUIDE**



SECTION 1

EO M503.01 – CREATE A PROPOSAL

Total Time:

30 min

PREPARATION

PRE-LESSON INSTRUCTIONS

Resources needed for the delivery of this lesson are listed in the lesson specification located in A-CR-CCP-805/PG-001, *Proficiency Level Five Qualification Standard and Plan*, Chapter 4. Specific uses for said resources are identified throughout the instructional guide within the TP for which they are required.

Review the lesson content and become familiar with the material prior to delivering the lesson.

Photocopy the Create a Proposal worksheet located at Attachment A for each cadet.

Photocopy the Create a Proposal Aide-Mémoire located at Attachment B for each cadet.

Photocopy the table of contents of A-CR-CCP-030/PT-001, *Water Safety Orders* for each cadet.

PRE-LESSON ASSIGNMENT

Nil.

APPROACH

An interactive lecture was chosen for this lesson to orient the cadets to project management and the writing of a proposal.

INTRODUCTION

REVIEW

Nil.

OBJECTIVES

By the end of this lesson the cadet shall be expected to create a proposal.

IMPORTANCE

It is important for cadets to create a proposal as it is an important step in the achievement of a project. A well thought out proposal allows people to get a better understanding of the project's workload, the necessary requirements for the project and if the project is feasible in the first place.

Teaching Point 1**Define project management.**

Time: 5 min

Method: Interactive Lecture

PROJECT

A project always has the following components:

Specific outcomes. Product or result.

Defined start and end date. Projects do not go on forever. Projects are temporary and are created to achieve particular results. When the results are achieved, the project ends.

Established budgets. Required amount of people, funds, facilities, equipment, and information.

Projects vary:

- **Large or small.** Organizing an inter-squadron sports competition is a large project. Organizing a sports event for senior cadets is a small project.
- **Involve a large of limited number of people.** Planning a squadron sports event is a project that involves many people. Reorganizing the furniture in a bedroom is also a project even though it only involves a limited number of people.
- **"Business-related" or personal.** Organizing the squadron's annual Christmas dinner is a business-related project. Having a dinner party for 12 people is a personal project.

PROJECT MANAGEMENT

Project management is the process of guiding a project from its beginning to its end. Project management includes three basic operations:

- planning;
- organizing; and
- controlling.

No matter what size the project, what needs to be performed is the same. Large projects may require more time to prepare than small projects but both still need to be structured.

Every project entails five phases:

1. **Conceive: Coming up with the idea.** This is the stage during which project managers come up with the project idea. It is at this stage that they determine the project's feasibility, its benefits and its limitations. At the end of this stage, project managers submit their project for approval.
2. **Define: Developing a plan.** This is the stage during which a detailed plan is developed.
3. **Start: Forming a team.** It is at this stage that people who need to know about the project are informed of it and are informed of their tasks.
4. **Perform: Doing the work.** This is when the work of the plan is put into action. This is where supervisors collect information (supervise) to identify deviations from the plans in order to apply corrective measures. This ensures that the objectives are attained.
5. **Close: Ending the project.** This is where a meeting is held to recognize achievements and discuss lessons that can be applied to the next project.

For small projects, the entire process can take a few days; larger projects may take many years. No matter how simple or complex the project, the process is the same.

CONFIRMATION OF TEACHING POINT 1

QUESTIONS:

- Q1. What are the five phases of a project?
 Q2. What is project management?
 Q3. In what stage is the proposal developed?

ANTICIPATED ANSWERS:

- A1. The five phases of a project are:
- Conceive: Coming up with the idea.
 - Define: Developing a plan.
 - Start: Forming a team.
 - Perform: Doing the work.
 - Close: Ending the project.
- A2. Project management is the process of guiding a project from its beginning to its end.
 A3. The proposal is developed during the first stage, which is the conceiving stage.

Teaching Point 2

Explain the conceiving phase of a project.

Time: 10 min

Method: Interactive Lecture

All projects begin with an idea. Sometimes the organization has specific requirement for a project; sometimes there is more freedom in the choice.

CHOOSING A PROJECT

A project organized within the Canadian Cadet Organizations (CCO) should be in-line with its aim.



Ask the cadets to list the aim of the CCO.

The aim of the CCO is to:

1. Develop in youth the attributes of good citizenship and leadership.
2. Promote physical fitness.
3. Stimulate the interest of youth in the sea, land and air activities of the Canadian Forces.

Cadets may be asked to participate in the organization of an exercise.

Here are examples of exercises that cadets may choose to organize:

- community service,
- leadership,
- healthy living,
- fitness and sports,
- marksmanship,
- drill,
- CF familiarization,
- aviation,
- aviation technology,
- aerospace, or
- survival.

CHOOSING AN ACTIVITY OR ACTIVITIES

When the exercise is chosen, activities that relate to the exercise have to be generated. According to CATO 11-03, *Cadet Program Mandate*, the vision of the Cadet Program (CP) is "a relevant, credible, and proactive youth development organization, offering the program of choice for Canada's youth, preparing them to become better leaders of tomorrow through a set of fun, challenging, well-organized and safe activities." That vision should be kept in mind when determining activities for a cadet exercise.

A good method to generate ideas is brainstorming.



Ask the cadets to list some guidelines on how to carry out a brainstorming activity.

Here are some guidelines:

- Write everything that comes to mind.
- Critique is prohibited: all ideas are welcomed.
- Use others ideas to generate new ideas.
- Produce a maximum of ideas.

For example, if cadets choose a fitness and sports exercise, they may brainstorm activities, such as:

- a race,
- a swim session,
- a karate session,
- a downhill skiing day,
- a boxing training session, and
- a tabloid event.

Before making a final decision, it is important to consider a few factors:

- the activity's or activities' goals, and
- the limitations that may stop the exercise from happening.



The age of participants should also be taken into consideration. What may be fun for first year cadets may not be as fun for third year cadets.

DETERMINING THE ACTIVITY'S OR ACTIVITIES' GOALS

Each activity that is part of the exercise has to have a specific goal. The goal of each activity should meet the CCO's aim.

Goals should be specific, measurable, achievable, relevant, and timed. Having clear expectations makes it easier to ensure the project maintains the right direction.



Ask the cadets to explain the concept of making goals SMART.

- **Specific.** The aim of the goal must be defined and everyone involved must be aware of it.
- **Measurable.** A standard to assess achievement must be identified.
- **Achievable.** The goal must be realistic and all required resources must be accessible to accomplish it.
- **Relevant.** The goal must be worthwhile for the people involved
- **Timed.** The goal must be able to be completed within the given time.

DETERMINING LIMITATIONS

At this stage, project managers have to determine the limitations that may put a stop to their project.

Such limitations may include:

- policies, and
- resources, such as:
 - schedule / time,
 - personnel,
 - transportation,
 - finance, and
 - equipment.

CONFIRMATION OF TEACHING POINT 2

QUESTIONS:

- Q1. What is the aim of the CCO? Why is it important to know it?
- Q2. What is a method of generating ideas for activities?
- Q3. What are some limitations that may put a stop to a project?

ANTICIPATED ANSWERS:

- A1. The aim of the CCO is to :
- Develop in youth the attributes of good citizenship and leadership.
 - Promote physical fitness.
 - Stimulate the interest of youth in the sea, land and air activities of the Canadian Forces.

It is important to know the aim of the CCO because a project organized within the Canadian Cadet Organizations (CCO) should be in-line with its aim.

- A2. Brainstorming is a method of generating ideas for activities.
- A3. Limitations that may put a stop to a project include:
- policies, and
 - resources, such as:
 - schedule / time,
 - personnel,
 - transportation,
 - finance, and
 - equipment.

Teaching Point 3

Explain the parameters of cadet activities with reference to policies.

Time: 5 min

Method: Interactive Lecture

A policy is a course or a principle of action created to guide leaders and to provide them with parameters for carrying out cadet activities. There are many policies and safety procedures to ensure cadets are participating in fun and challenging training safely. Those policies and procedures have to be taken into account when an exercise is being organized.

CADET ADMINISTRATIVE TRAINING ORDERS (CATOs)

CATOs contain a list of policies that apply to the administration and training of cadets across the country. Some policies restrict some activities and give guidance on others. For example, CATO 13-12, *Supervision of Cadets* describes the requirements for the number of instructors needed for each type of activity that may be carried out to ensure proper supervision.

WATER SAFETY ORDERS



Distribute the table of contents of A-CR-CCP-030/PT-001, *Water Safety Orders* to each cadet.

Water Safety Orders is a document that gives guidance on the organization of on-the-water (OTW) activities.

The document contains information on:

- water safety orders,
- powerboat safety orders,
- rowing safety orders,
- sailing safety orders,
- canoe / kayak safety orders,
- swimming safety orders, and
- scuba diving.

The information refers to floatation, the number of staff per cadet, wind, weather, equipment, clothing, night operation, wearing of shoes, capsizing drills, etc.



Other documents exist to guide leaders when planning various activities. They include:

The DND/CF *General Safety Guide for the Cadet Program* has been produced to assist leaders in the fulfillment of their safety leadership responsibilities. It can be found online at <http://www.cadets.ca/content-contenu.aspx?id=64062>

The A-GA-135-001/AA-001 *Flight Safety for the Canadian Forces* is an A–Z guide useable by companies, militaries, as well as countries, to start and run a flight safety program. It can be found online in the search section of www.airforce.forces.gc.ca

The A-CR-CCP-177/PT-001, *Cadet Marksmanship Program Reference Manual* contains guidance on the organization of marksmanship activities.

Some regions or detachments may have additional orders which amplify or clarify directives found in national documents.

CONFIRMATION OF TEACHING POINT 3

QUESTIONS:

- Q1. Which documents contain a list of national policies that apply to the administration and training of cadets across the country?
- Q2. What document must be used when organizing an activity on the water?
- Q3. What type of information can be found in this document?

ANTICIPATED ANSWERS:

- A1. CATOs.
- A2. Water Safety Orders should be used when planning OTW activities.
- A3. Information on the activities and the various safety procedures to be followed can be found in those documents.

Teaching Point 4

Explain how to write a proposal.

Time: 5 min

Method: Interactive Lecture

A proposal should tell how, when, by whom, and for how much. It needs to contain enough information for the supervisor to either accept or refuse the project.

By writing a proposal, it becomes clear to supervisors what the project will produce and the resources needed to carry it out.



Distribute the Create a Proposal worksheet to the cadets.

The proposal should include the following information:

- project title (type of exercise),
- activities selected,
- objective(s) of each activity, and
- limitations, such as:
 - policies,
 - schedule / time,
 - personnel,
 - finance, and
 - equipment.



Distribute the Create a Proposal Aide-Mémoire to the cadets.

Once the proposal is complete, it is submitted to the appropriate authority for approval.

CONFIRMATION OF TEACHING POINT 4**QUESTIONS:**

- Q1. What information should be included in a proposal?
- Q2. What are examples of limitations?
- Q3. What needs to be done when the proposal is complete?

ANTICIPATED ANSWERS:

- A1. A proposal should include the following information:
- project title (type of exercise),
 - activities selected,
 - objective(s) of each activity, and
 - limitations.
- A2. Some examples of limitations include:
- policies,
 - schedule / time,
 - personnel,
 - finance, and
 - equipment.
- A3. Once the proposal is complete, it is submitted to the appropriate authority for approval.

END OF LESSON CONFIRMATION

The cadets' creation of a proposal will serve as the confirmation of this lesson.

CONCLUSION

HOMEWORK / READING / PRACTICE

Nil.

METHOD OF EVALUATION

This EO is evaluated IAW A-CR-CCP-805/PG-001, *Proficiency Level Five Qualification Standard and Plan*, Chapter 3, Annex B, 503 PC.

CLOSING STATEMENT

Creating a proposal is an important step to making a project happen. The more thought put into the proposal, the more defined your ideas are, the easier the rest of the stages of the project should be. Creating a proposal clarifies the scope of the project and how much of a commitment is needed to make it happen.

INSTRUCTOR NOTES / REMARKS

Cadets will be given the opportunity to create a proposal, as a member of a group, as part of their OJT.

REFERENCES

A0-003 Director Cadets. (2006). *Cadet administrative and training orders index*. Retrieved May 25, 2006, from <http://www.cadets.ca/support/cato-oaic/intro.aspx>

A0-107 Director Cadets. (2007). CATO 14-31, *Director Cadets and Junior Canadian Rangers General Safety Program*. Ottawa, ON: Department of National Defence.

A1-010 A-CR-CCP-030/PT-001 Director Cadets 4. (2008). *Water safety orders*. Ottawa, ON: Department of National Defence.

C0-249 (ISBN 0-7894-2890-3) Heller, R. (1998). *How to Delegate*. New York, NY: DK Publishing, Inc.

C0-272 Coleridge Education, College of St. Mark and St. John. (2002). *A Consultation of Supervision Provision and Training Requirements Across Connexions Partnerships in England*. Retrieved March 17, 2008 from <http://www.connexions.gov.uk/partnerships/publications/uploads/cp/Supervisory%20Skills%20Exec%20Sum.pdf>

C0-273 (ISBN 978-1-56414-363-1) Ladew, D. P. (1998). *How to Supervise People: Techniques for Getting Results Through Others*. Franklin Lakes, NJ: Career Press.

C0-274 (ISBN 1-4134-1294-7) Sargent, G. (2003). *The Little Black Book of Supervision*. USA: Xlibris Corporation.

C0-452 Universite de Montréal. (2009). *Le remue-méninges*. Retrieved October 29, 2009, from http://www.ebsi.umontreal.ca/jetrouve/projet/etape1/brain_1.htm

C3-252 ISBN 978-0-470-04923-5 Portny, S. E. (2007). *Project management for dummies*. Hoboken, NJ: Wiley Publishing.

CREATE A PROPOSAL

Group members: _____

Date: _____

PROJECT:			
Selected Activities	Objectives	Limitations (Resources Required)	Others (Specify)

Approximate time needed for planning and preparation: _____

THIS PAGE INTENTIONALLY LEFT BLANK

Create a Proposal Aide-Mémoire

Steps to follow to create a proposal

1. Choose the project.
2. Choose the activity or activities.
3. Determine the goal of each activity.
4. Determine the limitations of each activity.

Questions to help you create a proposal and make a plan

Here is a list of questions to keep in mind when planning an activity. Some apply to the proposal planning stage and some need to be taken into consideration later in the process. Either way, it is good to be aware of these questions throughout the entire process.

- Are there policies that apply to this activity (eg, supervision)?
- Are there specific safety procedures to follow?
 - fire regulations,
 - medical / emergency situations,
 - weather,
 - equipment, and
 - specialist instructor.
- What are the requirements (if applicable) for:
 - transportation,
 - facilities,
 - supervision,
 - equipment,
 - food and water,
 - time,
 - specialist instructors, and
 - hygiene maintenance?
- What are the costs associated with the activity?
- Is there the potential for a Plan B (eg, bad weather, insufficient number of instructors)?
- Are there particular requirements for the cadets:
 - for dress / clothing,
 - to bringing lunch, and
 - to have a specific level of fitness, knowledge, or ability?

THIS PAGE INTENTIONALLY LEFT BLANK



**COMMON TRAINING
PROFICIENCY LEVEL FIVE
INSTRUCTIONAL GUIDE**



SECTION 2

EO M503.02 – PREPARE AN EXERCISE

Total Time:

60 min

PREPARATION

PRE-LESSON INSTRUCTIONS

Resources needed for the delivery of this lesson are listed in the lesson specification located in A-CR-CCP-805/PG-001, *Proficiency Level Five Qualification Standard and Plan*, Chapter 4. Specific uses for said resources are identified throughout the instructional guide within the TP for which they are required.

Review the lesson content and become familiar with the material prior to delivering the lesson.

Make OHPs of Figures A-1 and A-2 located at Attachment A.

Photocopy Exercise Plan Example located at Attachment B for each cadet.

Photocopy Exercise Plan Template located at Attachment C for each cadet.

Photocopy the Guided Discussion Worksheet located at Attachment D.

PRE-LESSON ASSIGNMENT

Have the cadets bring their Aide-Mémoire of EO M503.01 (Create a Proposal) to the class.

APPROACH

An interactive lecture was chosen for TPs 1, 2 and 4 to orient the cadets to the planning and preparation of an exercise.

An in-class activity was chosen for TP 3 as it is an interactive way to provoke thought and stimulate interest about plan format.

A guided discussion was chosen for TP 5 as it allows the cadets to discuss sustaining motivation during a project by sharing opinions, knowledge and experience with the group. The instructor, through a series of guided and follow-up questions, is able to stimulate the cadet's interest in sustaining motivation during an activity. The guided discussion contributes to the cadets' listening skills and team development.

INTRODUCTION

REVIEW

QUESTIONS:

- Q1. What is project management?
- Q2. What are the three basic operations included in project management?
- Q3. What are the five phases of project management?

ANTICIPATED ANSWERS:

- A1. Project management is the process of guiding a project from its beginning to its end.
- A2. Project management includes three basic operations:
- planning;
 - organizing; and
 - controlling.
- A3. The five phases of a project are:
- conceive: coming up with the idea;
 - define: developing a plan;
 - start: forming a team;
 - perform: doing the work; and
 - close: ending the project.

OBJECTIVES

By the end of this lesson the cadet shall be expected to prepare an exercise.

IMPORTANCE

It is important for cadets to know how to prepare an exercise, as it is not only a transferable skill, but it also gives them the tool to take initiative in organizing various events that will benefit cadets in their squadron.

Teaching Point 1**Explain the concept of a project audience.**

Time: 5 min

Method: Interactive Lecture

A project audience is any person or group that supports, is affected by, or is interested in a project. A project audience can be inside or outside the organization.

Knowing your project's audience helps you to:

- plan whether, when and how to involve them; and
 - determine whether the scope of the project is bigger or smaller than you originally had thought.
-

ACTIVITY

Time: 4 min

OBJECTIVE

The objective of this activity is to have the cadets see the scope a project audience can take.

RESOURCES

- Paper, and
- Pen / Pencil.

ACTIVITY LAYOUT

Nil.

ACTIVITY INSTRUCTIONS

1. Have cadets take out a piece of paper and a pen / pencil.
2. Inform the cadets that you will read a question to which they will have two minutes to write as many answers as possible.
3. Read the following question: "The senior cadets from this squadron have decided to organize a sports competition between this squadron and two other squadrons in the area. They are hoping to hold the competition three months from now in a local school gym. The competition will start at 0800 hrs and end at 1600 hrs and lunch will be provided to the entire group (estimation 100 cadets). Who needs to be contacted or informed for this event to happen?"
4. Allow two minutes for cadets to write their answers.
5. Alternating, have each cadet share one answer from their list and why they believe that those people should be involved in or informed of the project.
6. Answers may include:
 - cadets from all squadrons,
 - officers from all squadrons,
 - parents from all squadrons,
 - squadron parents committee from all squadrons,

- school authorities,
- equipment related personnel (supply officer or equipment rental agency),
- restaurant personnel (if planning on ordering food for the group),
- cleaners, and
- cadet detachment.



The list is not exhaustive. Cadets may have provided other answers that are correct. If they can correctly justify why certain people are involved, then their answer should be accepted as correct.

SAFETY

Nil.

CONFIRMATION OF TEACHING POINT 1

The cadets' participation in the activity will serve as the confirmation of this TP.

Teaching Point 2

Time: 25 min

Explain defining the plan.

Method: Interactive Lecture

There are many steps that need to be taken when defining a plan. They are as follows:

1. developing a work-breakdown structure (WBS);
2. determining precedence;
3. developing a schedule;
4. determining team members' skills and knowledge;
5. defining team members' roles and responsibilities;
6. determining and planning non-personnel resources;
7. identifying risk;
8. preparing a tracking system; and
9. confirming team members' participation.

DEVELOPING A WORK BREAKDOWN STRUCTURE (WBS)

Psychologists say human brains can normally comprehend 7–9 items simultaneously. For that reason, a project with dozens or even thousands of tasks may often be overwhelming. Project managers can deal with such projects by organizing the numerous tasks into phases to make them more manageable.

The most important guideline when preparing an exercise is thinking in detail. Project managers often underestimate the time and resources they need because they do not recognize everything they have to do to complete their tasks.

The WBS is a representation of all the tasks that have to be completed. The WBS allows leaders to see all tasks in an organized manner.

Those representations may take various forms. They are often displayed in the form of a hierarchical tree, but they can also be in the form of a tabular list.

As examples, Figure 1 shows a WBS for a hypothetical banquet and Figure 2 shows a WBS for a report preparation.



Show the cadets the slide of Figure A-1 located at Attachment A.



Show the cadets the slide of Figure A-2 located at Attachment A.

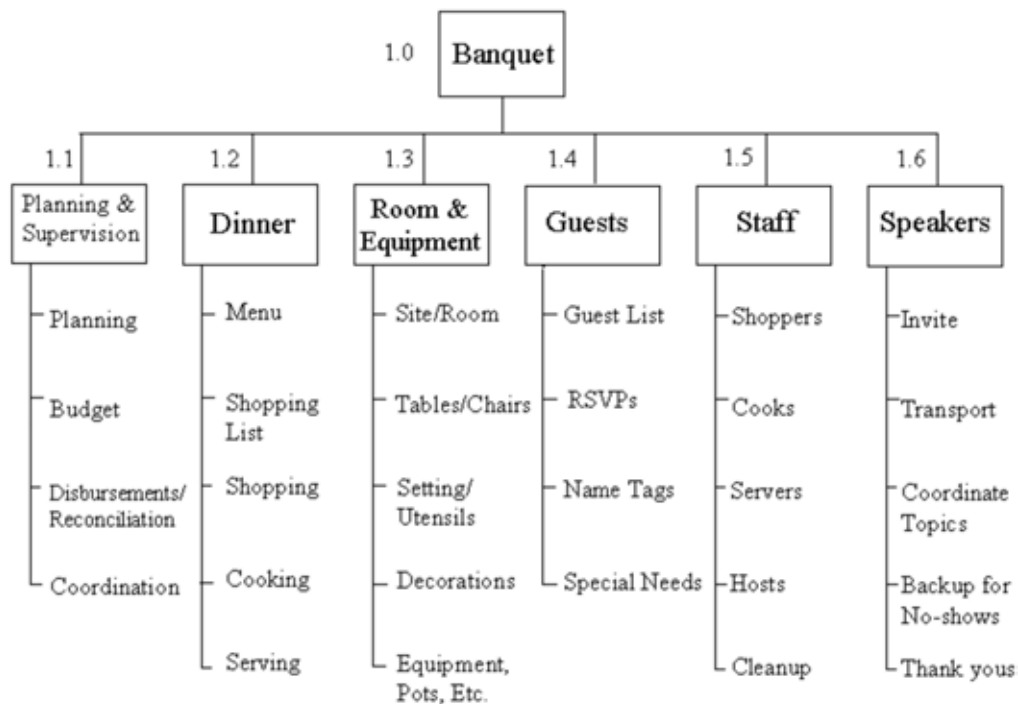

Figure 1 Banquet WBS

Note. From "Principle Based Project Management", 2007, *Work Breakdown Structure (WBS)*. Retrieved October 16, 2008, from http://www.hyperthot.com/pm_wbs.htm



Figure 2 Report Preparation WBS

Note. From *Project Management for Dummies* (p.76), by S. E. Portny, 2007, Hoboken, NJ: Wiley Publishing.

Here is how to develop a WBS:

1. Brainstorm all the necessary tasks for the exercise.
2. Group the tasks into a few major categories with common characteristics.
3. Within each category, group together the tasks that have the same characteristics.

To determine if the work has been broken into small enough pieces, answer these questions:

- Can the resources needed for the exercise be accurately estimated (personnel, equipment, raw materials, money, facilities, information, etc.)?
- Can the time requirements for each activity be accurately estimated?
- If some tasks were to be assigned to a stranger, would that person have sufficient detail to understand exactly what to do?



Here are some tips to improve the quality of the WBS:

- Involve the people who will be doing the work.
- Review information from previous similar projects.
- Make assumptions when there is uncertainty about a certain activity. Do not forget to update the WBS (or the plan) when that uncertainty is clarified.

The WBS does not take into consideration the chronological order in which each event should be done.

At this stage, it can be beneficial to identify obstacles that may be encountered throughout the project, in order to generate some contingency plan ideas.

DETERMINING PRECEDENCE

Once all the tasks have been outlined, it has to be determined in which order they have to be completed. Also, it has to be determined which events do not depend on others because they may be able to get accomplished concurrently with other tasks.

DEVELOPING A SCHEDULE

Once the precedence of tasks has been determined, the duration of each task has to be estimated. This step allows leaders to visualize how much time is needed prior to the conduct of the exercise, during the exercise and after the exercise.

The information could be displayed as follows:

	Activity	Required Time	Comments
1			
2			
3			
4			
5			
6			

Note. Created by Director Cadets 3, 2010, Ottawa, ON: Department of National Defence.

DETERMINING TEAM MEMBERS' SKILLS AND KNOWLEDGE

To accomplish the most with a minimum of time and resources, each task must be done in the correct order and each person must work at peak efficiency.

To ensure this happens, leaders should:

- determine which skills and knowledge they require to get the tasks done; and
- determine who is available and what skills they have to offer.

DEFINING TEAM MEMBERS' ROLES AND RESPONSIBILITIES

A leader may assign tasks for various reasons, such as:

- the assigned person is the most qualified or efficient at that task;
- the assigned person needs further practice at that task; or
- the assigned person has expressed an interest for that task.

No matter how the task is assigned, a leader's main focus should be to ensure the project is going to move along smoothly. If someone has been assigned a task in which they have little experience, then a leader should ensure the person receives sufficient support in accomplishing that task.

A leader may be able to delegate but that doesn't mean they have nothing to do with the task anymore. A leader may transfer the decision-making power to someone else, but they still need to ensure that the desired results are achieved.

Delegating is important for three reasons:

- to allow the leader to do other tasks;
- to have the most qualified person make decisions; and
- to develop subordinates' ability to handle additional assignments prudently and successfully.



Leaders should never assign other people tasks that they cannot clearly define themselves.

DETERMINING AND PLANNING NON-PERSONNEL RESOURCES

To determine and plan non-personnel resources, a leader should:

- look at every task outlined in the WBS and determine the requirements for each task; and
- determine how those requirements are going to be met.

IDENTIFYING RISK

The first step toward controlling risks is identifying them. Not all risks cause the same degree of concerns. Risk has to be managed throughout the duration of the project, from its beginning to its end.

Here is a list of possible risk factors that may arise during a project:

- insufficient time to prepare,
- missing parts to the plan (eg, wet weather plan),
- replacement of team member / leader, and
- a supporting activity (i.e. meals or transportation) has no assigned leader.

Leaders have to be aware of what may happen. In some cases, the risks are such that they create a requirement for a contingency plan (also referred to as Plan B).

PREPARING A TRACKING SYSTEM

Before the project starts, the desired results and the measures taken to ensure the desired results are achieved, have to be determined. Throughout the duration of the project, leaders need to maintain control, to ensure work is getting done. Monitoring performance makes it easier to detect problems.

Leaders should follow these procedures throughout a project's life:

- At the start of a project, reconfirm with people their commitments.
- At the start of a project, ensure people understand what is expected of them.
- Have people keep track of the work they perform.
- At agreed-upon intervals during the project, confirm with people the work they have completed.
- At intervals during the project, compare actual performance with planned performance, identify any problems, formulate, take corrective actions, and keep people informed.

CONFIRMING TEAM MEMBERS' PARTICIPATION

Starting a project off correctly is the key to ultimate success. As a project is about to start, here are things that should be done:

- Inform the people that the project is going to go ahead, that the plan is finalized.
- Confirm they are still available to support the project.
- Reconfirm the work expect from them.
- Advise them of the pre-exercise meeting. They should get a copy of the plan for review before the meeting. This will be when everyone becomes aware of what everyone's tasks are and that clarifications from the plan are made.



At this point, it is also important to start the groundwork for the post-project evaluation. Here are some guidelines to follow:

- Inform the team that there will be a post-exercise meeting at the end of the project.
- Encourage team members to record their problems, challenges, ideas and suggestions throughout the project.
- Clarify the criteria that define your project's success by reviewing the latest version of the project's objectives with team members.
- Maintain a own project log (project issues and occurrences) and encourage team members to do the same.



Before the pre-exercise meeting, leaders should meet with their supervisors to have the plan reviewed and approved. Leaders should be open minded to supervisors' feedback.

CONFIRMATION OF TEACHING POINT 2

QUESTIONS:

- Q1. What are the steps to defining a plan?
- Q2. What is a WBS?
- Q3. What are some procedures that can be followed to ensure the work is getting done?

ANTICIPATED ANSWERS:

- A1. The steps to defining a plan are:
1. developing a WBS;
 2. determining precedence;
 3. developing a schedule;
 4. determining team members' skills and knowledge;
 5. defining team members' roles and responsibilities;

6. determining and planning non-personnel resources;
 7. identifying risk;
 8. preparing a tracking system; and
 9. confirming team members' participation.
- A2. The WBS is a representation of all the tasks that have to be done. The WBS allows leaders to see all tasks in an organized manner.
- A3. Some procedures that can be followed to ensure the work is getting done are:
- At the start of a project, reconfirm with people their commitments.
 - At the start of a project, ensure people understand what is expected of them.
 - Have people keep track of the work they perform.
 - At agreed-upon intervals during the project, confirm with people the work they have completed.
 - At intervals during the project, compare actual performance with planned performance, identify any problems, formulate, take corrective actions, and keep people informed.

Teaching Point 3

Have the cadets create an exercise plan template.

Time: 20 min

Method: In-Class Activity

ACTIVITY

OBJECTIVE

The objective of this activity is to have the cadets create an exercise plan template.

RESOURCES

- Exercise Plan Example located at Attachment B,
- Exercise Plan Template located at Attachment C,
- Paper,
- Pen / Pencil,
- Flip Chart paper, and
- Markers.

ACTIVITY LAYOUT

Nil.

ACTIVITY INSTRUCTIONS

1. Divide the cadets in groups of no more than three.
2. Distribute paper, pen / pencil, flip chart paper and markers to each group.

- Tell the cadets they have to create a plan template that included all the information to be included in a plan. It has to be a template they could use.



Encourage the cadets to use their Create a Proposal Aide-Mémoire (EO M503.01 Create a Proposal), as it contains information that may help.

- Allow the cadets 10 minutes to work in groups.
- Allow a total of five minutes for all the groups to present their final work to the class.
- Distribute the Exercise Plan Example located at Attachment B and the Exercise Plan Template located at Attachment C and discuss elements that differ from the ones they have created.

SAFETY

Nil.

CONFIRMATION OF TEACHING POINT 3

The cadets' participation in the activity will serve as the confirmation of this TP.

Teaching Point 4

Explain starting the team.

Time: 20 min

Method: Interactive Lecture

It is important for people (especially cadets) to be informed at the appropriate time.



Review the concept of project audience.

Ask the cadets if they believe everyone in the project audience needs to be informed at the same time. Why or why not?

ANNOUNCING THE EXERCISE

The people affected by the exercise need to be informed at various times depending on the tasks or impact they have on the exercise.

Before announcing an exercise to cadets, leaders need to ask themselves if the time is appropriate to make an announcement. They can ask themselves questions, such as "Are we ready to make this announcement?" or, "Is this going to allow sufficient time for the cadets to prepare for the exercise?"

There are many ways to announce the exercise to the cadets, such as:

- email,
- a written announcement in the squadron's newsletter or monthly schedule,
- a verbal announcement at the end of a training session, or
- a formal meeting.

PLANNING A SUCCESSFUL PRE-EXERCISE MEETING

The information in a pre-exercise meeting must include:

- what has to be done;
- when it has to be done;
- how it has to be done;
- by whom it has to be done; and
- available resources.

To have a good meeting, there needs to be some preplanning. Here are some pointers:

Decide who needs to attend and why. People who have necessary information or the authority to make specific decisions should be in attendance.

Give plenty of notice of the meeting. This increases the chances that the people you want to attend will be available.

Let the people who should attend the meeting know its purpose. People are most likely to attend a meeting if they understand why their attendance is important.

Prepare a written agenda that includes topics and their allotted times. This document helps people see why attending the meeting is in their interests. It is also the guide to running the meeting.

Circulate the agenda and any necessary material (eg, plan) in advance. This gives everyone time to suggest changes to the agenda and to plan for the meeting.

Keep meetings to an hour or less. People can be forced to sit in a room for hours, but they cannot be forced to keep their minds on the activities and information. If necessary, several meetings of one hour or less to discuss complex issues or multiple topics can be scheduled.

Here are essentials for conducting a productive meeting:

Start on time, even if people are absent. When people see that a leader waits for latecomers, they have a tendency to show up late! When people see a leader that starts on time, they show up on time!

Assign a timekeeper. This person reminds the group when a topic has exceeded its allocated time.

Take detailed notes (minutes) of who attended, the items discussed, and the decisions and assignments the group made. This procedure allows people to review and clarify the information and serves as a reminder of actions to be taken after the meeting.

Keep a list of items that need further action (action list), and assign one person to be responsible for each item. This step helps ensure that when discussing these issues again, the right information and responsible people are present.

If you do not have the right information or the right people to resolve an issue, stop the discussion and put it on the action list. Discussing an item without having the necessary information or the right people present is just wasted time.

End on time. Meeting attendees may have other commitments that begin when the meeting is supposed to end. Not ending on time causes people to be late for their next commitments or to leave the meeting before it is over.

When a project runs over a long period of time, regularly scheduled meetings give members an opportunity to share progress and issues. Consulting with team members to develop a meeting schedule is a way to ensure meeting times are convenient for as many people as possible. For those meetings, it may be beneficial to create a progress report to give everyone a brief overview of how the project is coming together. That should be distributed beforehand with any other background information related to the topics on the agenda.

CONFIRMATION OF TEACHING POINT 4

QUESTIONS:

- Q1. What are some ways to announce an exercise?
- Q2. What information must be included a pre-exercise meeting?
- Q3. What is a meeting agenda? Why is it important?

ANTICIPATED ANSWERS:

- A1. There are many ways to announce an exercise, such as:
- email,
 - written announcement in the squadron's newsletter or monthly schedule,
 - verbal announcement at the end of a training session, or
 - formal meeting.
- A2. The information in a pre-exercise meeting must include:
- what has to be done;
 - when it has to be done;
 - how it has to be done;
 - by whom it has to be done; and
 - available resources.
- A3. A written agenda is a guide for running the meeting. It is important because it helps people see why attending the meeting is in their interests. Circulating it in advance gives everyone time to suggest changes to the agenda and to plan for the meeting.

Teaching Point 5

Have the cadets discuss sustaining motivation during a project.

Time: 10 min

Method: Guided Discussion



It is recommended that the facilitator review the instructional guide for EO M403.03 (Motivate Team Members) prior to conducting the guided discussion.

BACKGROUND KNOWLEDGE



The point of the guided discussion is to present the following information to the group using the tips for answering / facilitating discussion and the suggested questions provided.

The guided discussion is an instructional method where new material is presented to the group and specific learning objectives must be achieved. Unlike a group discussion, the group may not have any previous experience, opinion or training on the material.

The guided discussion focuses on the group determining the correct answers to specific questions through discussion as opposed to participating in a discussion to only voice an opinion or share an experience.

Facilitate the guided discussion and have an assistant record observations, comments and answers to focus on the discussion. The notes made by the assistant will then be used during the summary portion of the discussion to ensure that all learning objectives are met.

MOTIVATION

Even though motivation is a personal choice, leaders can create the opportunity for others to become motivated by giving them a sense of:

- desirability: giving value to achieving the goal;
- feasibility: having people believe the project can be done;
- progress: letting people know how they are doing; and
- recognition: recognizing work well done.

Desirability: Why should I want to do this project? How is this project beneficial to me?

When people feel a connection to the project, they are more inclined to work toward its accomplishment.

There are many ways for leaders to develop the notion that a project is personally beneficial. They can get team members to discuss:

- personal interests and goals and relating those to aspects of the project.
- past projects that they enjoyed and why they enjoyed them.
- some of the benefits that they hope to realize by working on the project and the value of those benefits.

Feasibility: Is this project even possible?

What seems impossible to one person can seem feasible to another. If a project does not seem possible, people are not going to give it their full effort.

The assessment of feasibility can become a self-fulfilling prophecy. If people think an assessment is feasible, they will work hard to complete it; if they encounter problems, they will try to work them out. However, if people really believe they have no chance of succeeding, they give up at the first sign of difficulty. Any problems just confirm what they already knew—the project was doomed from the start. Of course, as soon as they give up, they have no chance of succeeding, so their initial belief is that the project wasn't feasible has been confirmed. No matter how desirable people may feel a project is, they will give up more easily when they encounter any difficulties if they are convinced that nothing they do can cause it to succeed. People do not need a guarantee of success, but they must believe they have a chance.

To help people believe a project is feasible, leaders can:

- encourage members to identify potential concerns, so they can be addressed; or
- explain why they feel that targets and plans are feasible.

Progress: How I am doing so far?

People have to know how they are doing over time for various reasons, such as:

- achieving intermediate goals provides them personal satisfaction;
- recognizing their successes confirms they are on the right track; and
- successfully completing intermediate goals reinforces their beliefs that they can accomplish the final goals.



People tend to wait until the last minute when no other motivation comes their way.

To help keep people on track and excited about the project:

- establish meaningful and frequent intermediate goals;
- continually assess how people are doing;
- frequently share information with people about their performance; and
- continually reinforce the project's potential benefits.

Recognition: Am I being appreciated for all the hard work I have been doing?

People like to be recognized when they are working hard. However, leaders should be aware that there are guidelines to follow when formalizing that appreciation.

Rewards can take multiple forms, such as:

- talking with the person and expressing your appreciation;
- expressing appreciation in a written note or email;
- expressing appreciation in writing to the person's supervisor;
- issuing the person a certificate of appreciation; and
- taking the person out to lunch.

To make the rewards most effective:

- be sure that acknowledgment and appreciation is honest and sincere; and
- respect the person's personal style and preferences when giving the reward:
 - Some people enjoy receiving acknowledgments in front of their peers, while others prefer receiving them in private.
 - Some people appreciate receiving an individual award; others appreciate receiving an award presented to the entire team.

GUIDED DISCUSSION



TIPS FOR ANSWERING / FACILITATING DISCUSSION:

- Establish ground rules for discussion, eg, everyone should listen respectfully; don't interrupt; only one person speaks at a time; no one's ideas should be made fun of; you can disagree with ideas but not with the person; try to understand others as much as you hope they understand you; etc.
- Sit the group in a circle, making sure all cadets can be seen by everyone else.
- Ask questions that will provoke thought; in other words avoid questions with yes or no answers.
- Manage time by ensuring the cadets stay on topic.
- Listen and respond in a way that indicates you have heard and understood the cadet. This can be done by paraphrasing their ideas.
- Give the cadets time to respond to your questions.
- Ensure every cadet has an opportunity to participate. One option is to go around the group and have each cadet answer the question with a short answer.
- Additional questions should be prepared ahead of time.



Take time to introduce the material so the group is oriented for the discussion. The introduction can take the form of an introductory statement / paragraph or can be completed with an in-class activity or exercise prior to the guided discussion.

The introduction is only used to orient the group to the material and should not be used to issue control statements or set ground rules.



During the discussion, take notes on the Guided Discussion worksheet located at Attachment D.

INTRODUCTION

The aim of PO 503 is to provide the tools to take a project from its conception to its end, and that means through its execution. Since a project's success depends on the project manager's ability to organize, coordinate, and support a diverse team that is working toward a common goal, this lesson is going to allow discussing the execution of a plan, and specifically how to keep the members motivated throughout the duration of the project.



Develop other questions and answers throughout the guided discussion; however, it is important to use the prepared questions to ensure the learning objectives are met. Develop follow-up questions so knowledge can be confirmed or if time permits, deeper exploration of the topic can occur.



Reinforce those answers given and comments made during the guided discussion, ensuring each learning objective is achieved.

PREPARED QUESTION:

Q1. How is motivation created? Where does motivation come from?

ANTICIPATED ANSWER:

A1. Even though motivation is a personal choice, leaders can create the opportunity for others to become motivated by giving them a sense of:

- desirability: giving value to achieving the goal;
- feasibility: having people believe the project can be done;
- progress: letting people know how they are doing; and
- recognition: recognizing work well done.

Desirability

PREPARED QUESTION:

Q1. How do people react when they work on a project they believe is personally beneficial to them?

ANTICIPATED ANSWER:

A1. When people feel a connection to the project, they are more inclined to work toward its accomplishment.

Follow-Up Question if Required:

Q1. How can people develop the notion that a project is beneficial to them?

Follow-Up Answer if Required:

A1. There are many ways for leaders to develop the notion that a project is personally beneficial. They can get team members to discuss:

- personal interests and goals and relating those to aspects of the project.
- past projects that they enjoyed and why they enjoyed them.
- some of the benefits that they hope to realize by working on the project and the value of those benefits.

Feasibility

PREPARED QUESTIONS:

Q1. Do you believe feasibility is the same for everyone? How does it differ between individuals?

Q2. How does it affect the people's attitude towards a project? How do people react when they work on a project they believe is unfeasible in opposition to a project they believe is feasible?

ANTICIPATED ANSWERS:

- A1. Of course, feasibility is a subjective assessment. What seems impossible to one person can appear feasible to another.
- A2. Assessment of feasibility can become a self-fulfilling prophecy. If people think an assessment is feasible, they will work hard to complete it; if they encounter problems, they will try to work them out. However, if people really believe they have no chance of succeeding, they give up at the first sign of difficulty. Any problems just confirm what they already knew — the project was doomed from the start. Of course, as soon as they give up, they have no chance of succeeding, so their initial belief is that the project wasn't feasible has been confirmed. No matter how desirable people may feel a project is, they will give up more easily when they encounter any difficulties if they are convinced that nothing they do can cause it to succeed. People do not need a guarantee of success, but they must believe they have a chance.

Follow-Up Question if Required:

- Q1. How can people develop the notion that a project is feasible?

Follow-Up Answer if Required:

- A1. People can develop the notion that a project is feasible by:
- identifying potential concerns to the leader and getting them addressed; or
 - having the leader explain why they feel that targets and plans are feasible.

Progress

PREPARED QUESTION:

- Q1. Why should people be informed of how they are progressing?

ANTICIPATED ANSWER:

- A1. People have to know how they are doing over for various reasons, such as:
- achieving intermediate milestones provides personal satisfaction;
 - recognizing their successes confirms they are on the right track; and
 - successfully completing intermediate steps reinforces their beliefs that they can accomplish the final goals.

Follow-Up Questions if Required:

- Q1. How do you feel when someone takes some interest in the work you have done? That such and such an area needs improvement or that you have done a great job so far?
- Q2. Have you ever seen a three-month project where all the major milestones occur in the last 3–4 weeks? When do you think people get serious about the project?
- Q3. How could you have kept those people on track earlier in the process?

Follow-Up Answers if Required:

- A1. Answers will vary.
- A2. People tend to wait until the last minute, when no other motivation comes their way.

A3. Do the following to help keep people on track and excited about the project:

- establish meaningful and frequent intermediate milestones;
- continually assess how people are doing;
- frequently share information with people about their performance; and
- continually reinforce the project's potential benefits.

Recognition

PREPARED QUESTION:

Q1. What are forms of rewards that you can give people?

ANTICIPATED ANSWER:

A1. Rewards can take multiple forms, such as:

- talking with the person and expressing your appreciation;
- expressing appreciation in a written note or email;
- expressing appreciation in writing to the person's supervisor;
- issuing the person a certificate of appreciation; and
- taking the person out to lunch.

Follow-Up Question if Required:

Q1. What are ways to make those rewards most effective?

Follow-Up Answer if Required:

A1. To make the rewards most effective:

- be sure your acknowledgment and appreciation is honest and sincere.
- respect the person's personal style and preferences when giving the reward:
 - Some people enjoy receiving acknowledgments in front of their peers, while others prefer receiving them in private.
 - Some people appreciate receiving an individual award; others appreciate receiving an award presented to the entire team.



As a confirmation question, you can ask: "What are ways to encourage motivation?"
Answers should include:

- desirability: giving value to achieving the goal;
- feasibility: having people believe the project can be done;
- progress: letting people know how they are doing; and
- recognition: recognizing work well done.

SUMMARY



The summary is used to cover all comments, answers, and discussion that developed throughout the guided discussion. The summary is not used as a confirmation of the material discussed. Use the notes from the Guided Discussion Worksheet to prepare the summary emphasizing points that support the learning objectives of the guided discussion.



Reinforce those answers given and comments made during the group discussion, ensuring the teaching point has been covered.

CONFIRMATION OF TEACHING POINT 5

The cadets' participation in the guided discussion will serve as the confirmation of this TP.

END OF LESSON CONFIRMATION

The cadets' preparation of an activity will serve as the confirmation of this lesson.

CONCLUSION

HOMEWORK / READING / PRACTICE

Nil.

METHOD OF EVALUATION

This EO is evaluated IAW A-CR-CCP-805/PG-001, *Proficiency Level Five Qualification Standard and Plan*, Chapter 3, Annex B, 503 PC.

CLOSING STATEMENT

Preparation is the key to success. A well thought plan allows operations to go smoothly. Being able to plan and prepare is a skill that may be used in many life opportunities, and is therefore a very important transferable skill set.

INSTRUCTOR NOTES / REMARKS

Cadets shall be given the opportunity to prepare a cadet exercise, as a member of a group, as part of their OJT.

REFERENCES

A0-200 B-GL-303-002/FP-000 Canadian Forces. (1995). *Operational staff procedures : Staff duties in the field. (Volume 2)*. Ottawa, ON: Department of National Defence.

C0-453 Doc Stoc. (2009). *Format for activity plan*. Retrieved November 1, 2009, from <http://www.docstoc.com/docs/4977554/FORMAT-FOR-ACTIVITY-PLAN>

C3-252 ISBN 978-0-470-04923-5 Portny, S. E. (2007). *Project management for dummies*. Hoboken, NJ: Wiley Publishing.

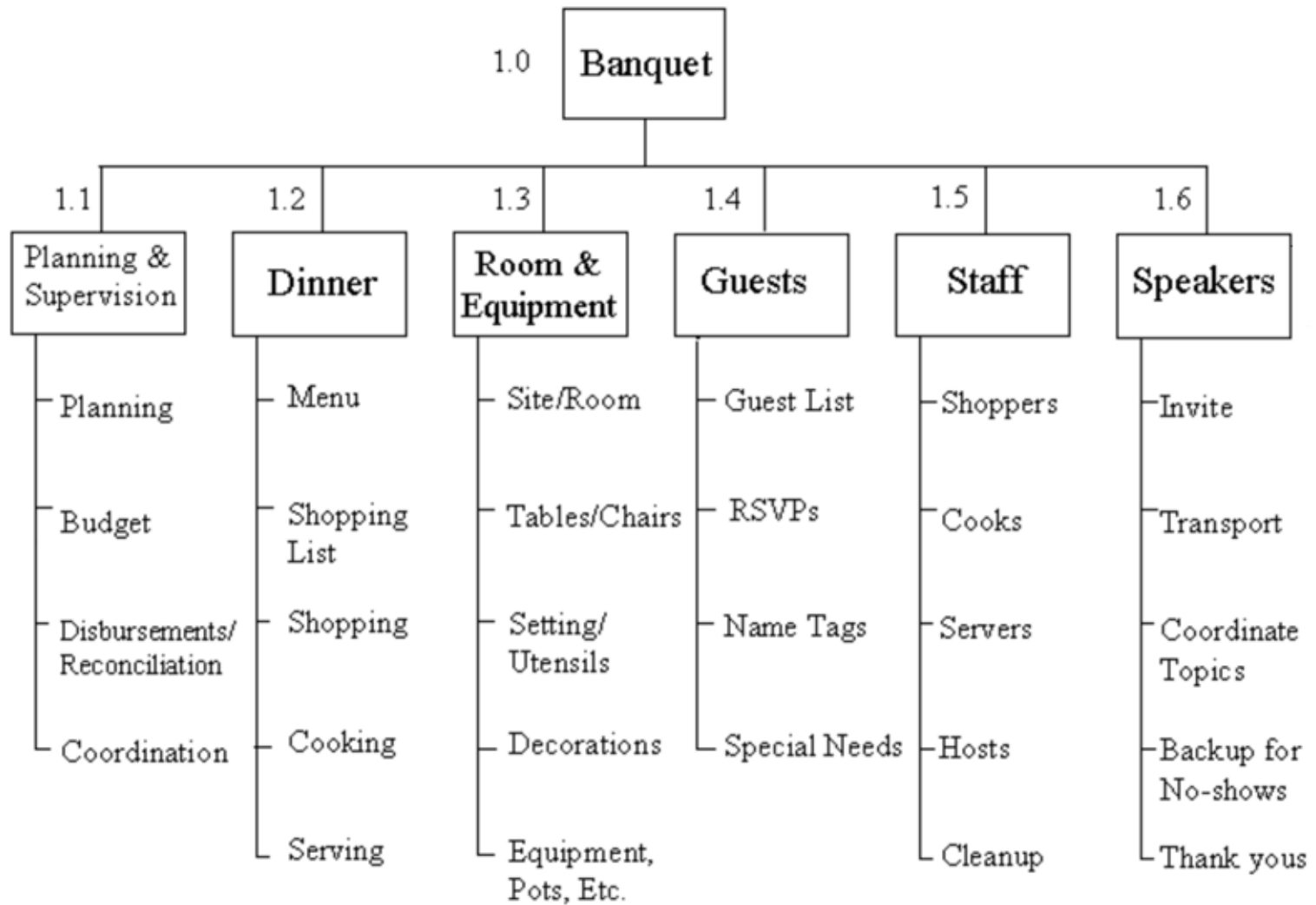

Figure A-1 Banquet WBS

Note. From "Principle Based Project Management", 2007, *Work Breakdown Structure (WBS)*. Retrieved October 16, 2008, from http://www.hyperhot.com/pm_wbs.html

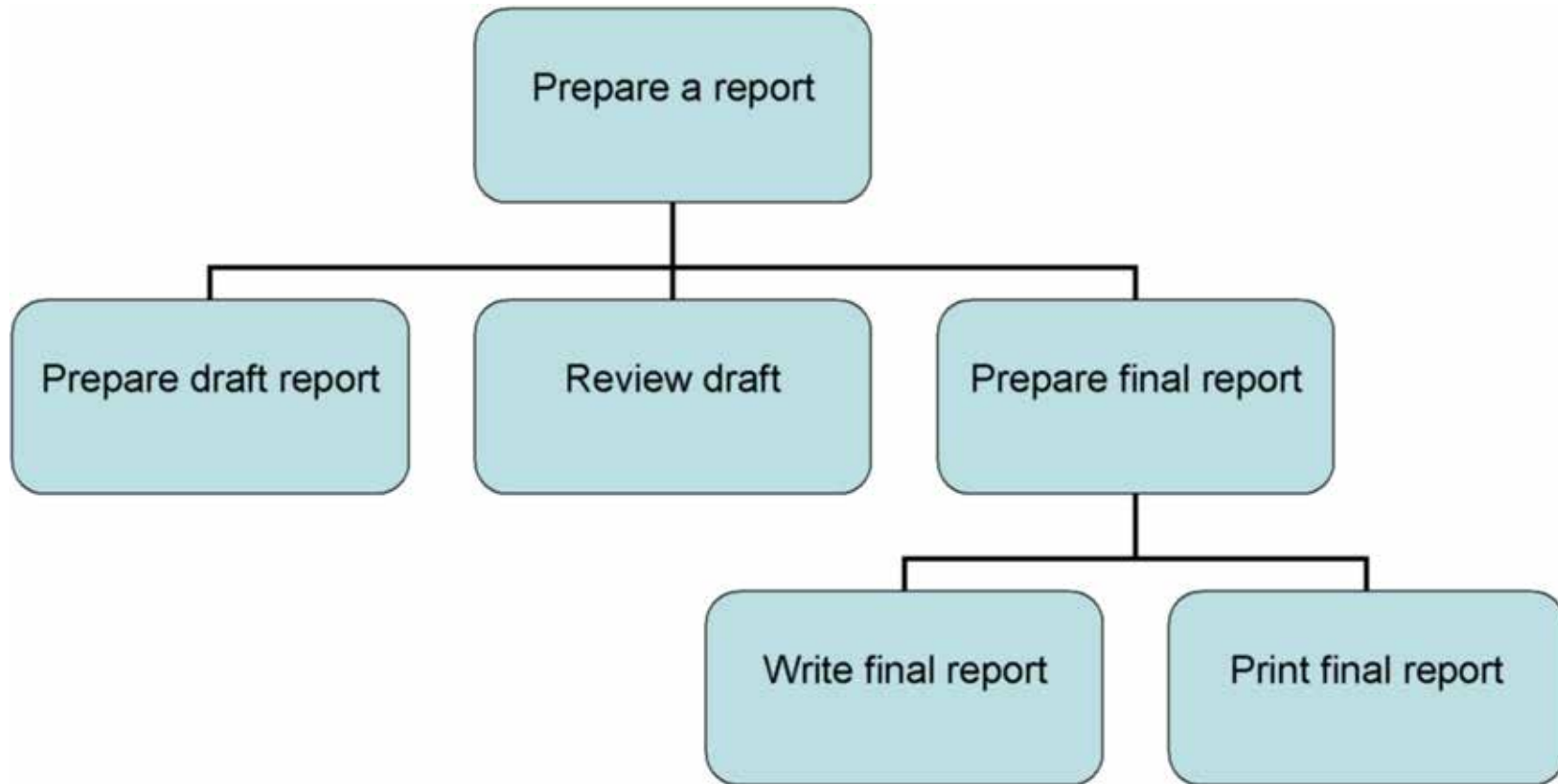

Figure A-2 Report Preparation WBS

Note. From *Project Management for Dummies* (p.76), by S. E. Portny, 2007, Hoboken, NJ: Wiley Publishing.

EXERCISE PLAN EXAMPLE

TITLE OF THE EXERCISE: SPORTS EVENT: OPERATION GET-YOUR-MOVE-ON

WHAT

Who is involved, what is going to happen, where and when?

Example: Unit 123 Moncton will participate in Operation GET-YOUR-MOVE-ON, a sports event to be conducted at the Moncton Everblue High School on 10 Mar 2012 from 0900 hrs–1600 hrs.

WHY

Why is this happening?

Example: Unit 123 Moncton will conduct the sports event to promote physical fitness amongst all cadets, to introduce them to various sports, and to develop leadership and refereeing skills in senior cadets. The event will take place over one day to allow the conduct of multiple sports.

HOW

A. General Outline

What are the main parts of the exercise?

Example: This exercise will be conducted in five phases:

1. Phase One – Administration

The pre-activity meeting will be conducted on 21 Feb 12 in the CO's office at 1730 hrs. All members will attend. Booking of facilities, administrative preparation and planning are being completed by the Training Officer.

2. Phase Two – Preparation of Facilities

Prior to the cadets' arrival, all sergeants are required to prepare the facilities. The equipment for all sports events is to be taken out of the supply room and placed in the appropriate area. Signs identifying bathrooms, water points, and safety points have to be put up. This should be completed NLT 0840 hrs.

3. Phase Three – Conduct of the Exercise

As per schedule. Will include safety briefing, warm-up, conduct of the sports, lunch, cool-down and activity debriefing. Cadets will be allowed to leave at 1600 hrs.

4. Phase Four – Return of Stores

Return of stores, clean-up of facilities.

5. Phase Five - Post-exercise meeting

Post-exercise meeting will be conducted on Monday 11 Mar 2012 at the CO's office from 1700 hrs to 1830 hrs. All senior cadets and officers will attend.

B. Groupings

Are there particular groups you need created?

Example: Cadets will be divided upon arrival into four different sports teams. WO1 Mackey will ensure this is done as soon as cadets are on ground.

C. Tasks

What are the tasks specific to each person?

WHO	TASKS
Capt Malloy	<ul style="list-style-type: none"> • Plan the sports event. • Book school facilities. • Deliver the safety briefing upon arrival. • Deliver the event's debriefing.
Lt Nixon	<ul style="list-style-type: none"> • Responsible for meal arrangements. • Responsible for all medical emergencies. First-aider for the event.
WO1 Mackey	<ul style="list-style-type: none"> • Responsible to ensure that equipment and signs are ready before 0840 hrs as per Annex C. • Responsible to ensure all activities are carried out safely and according to the timetable. • Responsible to have cadets divided into four sports teams.
WO2 Landry	<ul style="list-style-type: none"> • Responsible for the training and evaluation of all activity referees. • Offer feedback to activity referees. • Complete and submit an individual evaluation of all referees to the Training Officer.
FSgt Gagnon	<ul style="list-style-type: none"> • Responsible for the evaluation all activity referees. • Offer feedback to activity referees. • Complete and submit an individual evaluation of all referees to the Training Officer.
Sgt Penny	<ul style="list-style-type: none"> • Responsible for equipment set-up and tear-down • Become familiar with and referee soccer. • Become familiar with and referee volleyball.
Sgt Randell	<ul style="list-style-type: none"> • Responsible for equipment set-up and tear-down. • Become familiar with and referee soccer. • Become familiar with and referee volleyball.
Sgt Picard	<ul style="list-style-type: none"> • Responsible for equipment set-up and tear-down. • Become familiar with and referee ball hockey. • Become familiar with and referee badminton.
Sgt Clark	<ul style="list-style-type: none"> • Responsible for equipment set-up and tear-down. • Become familiar with and referee ball hockey. • Become familiar with and referee badminton.
Sgt Belliveau	<ul style="list-style-type: none"> • Responsible for set-up and tear-down. • Responsible to carry out the warm-up and the cool-down. • Responsible for the tug-of-war event.
All members	<ul style="list-style-type: none"> • All members are to look after safety. • Anything deemed unsafe should be stopped right away and rectified.

D. Timings

What are the timings of this event?

Example: See timetable in Annex A.

E. Dress

What should people wear to the event?

Example: Dress for the event will be suitable sports gear. No outdoor footwear shall be worn inside.

WITH WHAT - RESOURCES

What else do people need to know to put the plan into action?

Example:

Rations

Rations will be arranged by Lt Nixon.

Accommodations

Arrangements for the school are to be made by Capt Malloy.

Equipment

See Annex B for Equipment List.

See Annex C for Activity Layout.

Transport

Cadets are responsible for their own transportation to and from the school.

Emergency Procedures

All medical emergencies will be reported to Lt Nixon. First aid will be available on site, and will be given if necessary. Medical emergencies will be directed to 911.

Water

Water will be available at school fountains. All cadets are to bring a personal water bottle to have water on hand.

Hygiene

The school washrooms (toilets and showers) will be available.

CHAIN OF COMMAND

What is the chain of command in the event? Who is in charge of what?

Example:

Planning: Capt Malloy

Conduct: WO1 Mackey

Evaluation: WO2 Landry, FSgt Gagnon

Rations: Lt Nixon

First-Aider: Lt Nixon

Referees: Sgt Penny, Sgt Randell, Sgt Picard, Sgt Clark and Sgt Belliveau

Capt R. Malloy

TrgO

123 Moncton

Distribution List

Who needs to know about this plan?

Example:

CO

DCO

Capt Malloy

Lt Nixon

WO1Mackey

WO2 Landry

FSgtGagnon

Sgt Penny

Sgt Randell

Sgt Picard

Sgt Clark

Sgt Belliveau

List of Annexes

What annexes does your plan require?

Example:

Annex A - Timetable

Annex B - Equipment

Annex C - Exercise Layout

Annex A

TIMETABLE

Period	Time	What	Who	Comments
1	0810–0840 hrs	Set-up	All Sergeants	
2	0840–0900 hrs	Cadets arrival	All senior cdts	
3	0900–0910 hrs	Attendance		
4	0910–0920 hrs	Safety briefing	Capt Malloy	WO1 to divide teams at this time.
5	0920–0930 hrs	Warm up	Sgt Belliveau	
6	0940–1010 hrs	Game 1	Sgt Randell Sgt Penny	Soccer (Teams 1 vs 2) Volleyball (Teams 3 vs 4)
7	1010–1030 hrs	Break		
8	1030–1100 hrs	Game 2	Sgt Penny Sgt Randell	Soccer (Teams 1 vs 3) Volleyball (Teams 2 vs 4)
9	1100–1120 hrs	Break		
10	1120–1200 hrs	Game 3	TBD*	Soccer (Teams 3 vs 4) Volleyball (Teams 1 vs 2)
11	1200–1300 hrs	Lunch		
12	1300–1330 hrs	Game 4	Sgt Picard Sgt Clark	Hockey (Teams 1 vs 2) Badminton (Teams 3 and 4)
13	1330–1350 hrs	Break		
14	1350–1420 hrs	Game 5	Sgt Clark Sgt Picard	Hockey (Teams 3 vs 4) Badminton (Teams 1 and 2)
15	1420–1440 hrs	Break		
16	1440–1510 hrs	Game 6	TBD*	Hockey (Teams 1 vs 4) Badminton (Teams 2 and 3)
17	1510–1535 hrs	Tug of war	Sgt Belliveau	
18	1535–1545 hrs	Cool down	Sgt Belliveau	
19	1545–1600 hrs	Debriefing	Capt Malloy	
20	1600 hrs	Departure	All senior cdts	

* Based on previous experience of both sports, determine who may need more practice and assign as appropriate.

Annex B

EQUIPMENT LIST

- Hockey sticks x 20
- Hockey masks x 20
- Hockey gloves x 20
- Protective goggles x 20
- Hockey nets x 2
- Pucks x 2
- Badminton rackets x 20
- Badminton birds x 6
- Badminton sets (nets and poles) x 3
- Pinnies x 20 of each colour (2 colours)
- Volleyball set (nets and poles) x 1
- Volleyball ball x 2
- Large 18-m (60-foot) rope x 1
- First aid kit x 2

EXERCISE LAYOUT

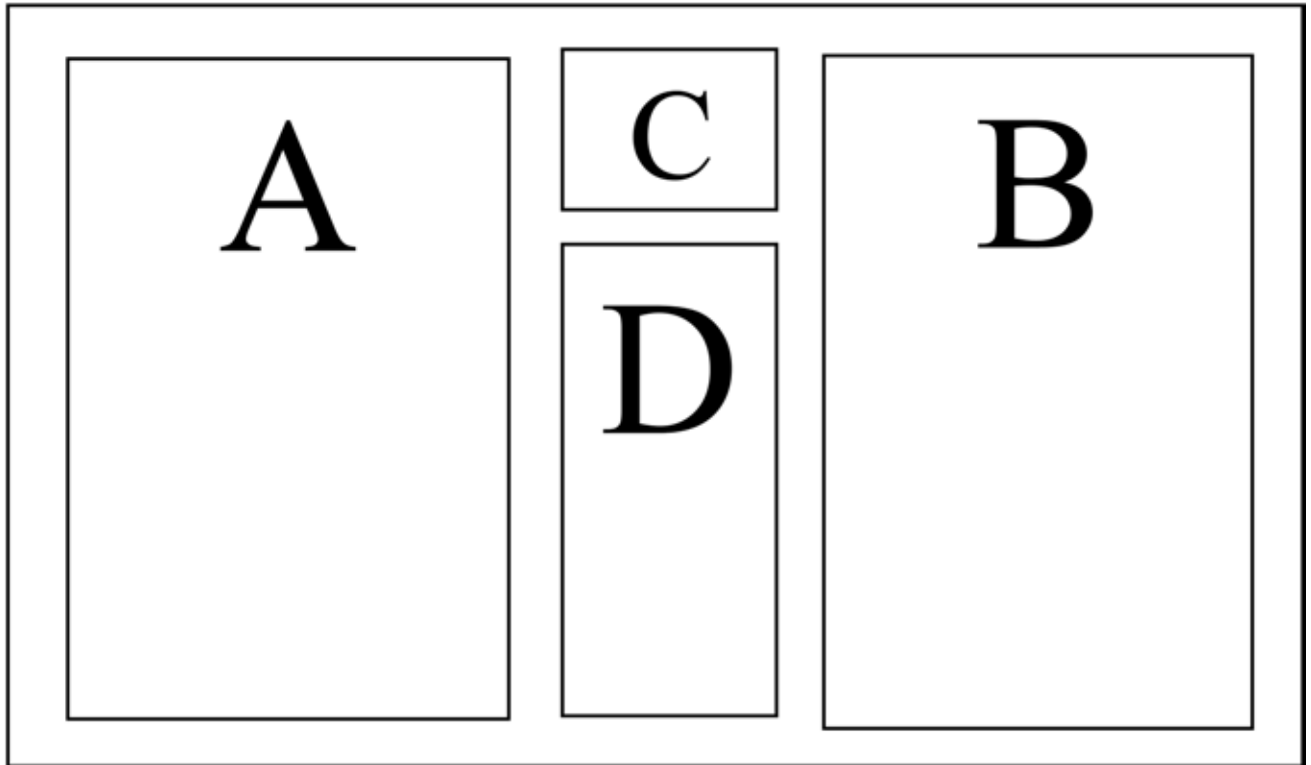

Legend:

A: Soccer / Hockey

B: Volleyball / Badminton

C: First Aid Station

D: Tug of War

THIS PAGE INTENTIONALLY LEFT BLANK

EXERCISE PLAN TEMPLATE

TITLE OF THE PROJECT: _____

WHAT

WHY

HOW

A. General Outline – Main Events

Phase ____ → _____

Phase ____ – _____

Phase ____ – _____

Phase ____ → _____

Phase ____ – _____

B. Groupings

C. Tasks

Who	Tasks	Comments

D. Timings

E. Dress

RESOURCES

1. _____

2. _____

3. _____

4. _____

5. _____

6. _____

7. _____

8. _____

9. _____

10. _____

11. _____

12. _____

CHAIN OF COMMAND

By: _____
Position: _____
Unit: _____

Distribution List

List of Annexes

Annex ___ - _____
Annex ___ - _____
Annex ___ - _____
Annex ___ - _____
Annex ___ - _____
Annex ___ - _____

GUIDED DISCUSSION WORKSHEET

TP 5: Discuss sustaining motivation during a project.

INTRODUCTION

The aim of PO 503 is to provide the tools to take a project from its conception to its end, and that means through its execution. Since a project's success depends on the project manager's ability to organize, coordinate, and support a diverse team that is working toward a common goal, this lesson is going to allow discussing the execution of a plan, and specifically how to keep the members motivated throughout the duration of the project.

GUIDED DISCUSSION

Prepared Content / Learning Objectives	Notes / Comments / Answers from the Guided Discussion for Summary
<p>Motivation</p> <hr/> <p>PREPARED QUESTION:</p> <p>Q1. How is motivation created? Where does motivation come from?</p> <hr/> <p>ANTICIPATED ANSWER:</p> <p>A1. Even though motivation is a personal choice, leaders can create the opportunity for others to become motivated by giving them a sense of:</p> <ul style="list-style-type: none"> • desirability: giving value to achieving the goal; • feasibility: having people believe the project can be done; • progress: letting people know how they are doing; and • recognition: recognizing work well done. 	
<p>Desirability</p> <hr/> <p>PREPARED QUESTION:</p> <p>Q1. How do people react when they work on a project they believe is personally beneficial to them?</p> <hr/> <p>ANTICIPATED ANSWER:</p> <p>A1. When people feel a connection to the project, they are more inclined to work toward its accomplishment.</p>	

Prepared Content / Learning Objectives	Notes / Comments / Answers from the Guided Discussion for Summary
<p>Follow-Up Question if Required:</p> <p>Q1. How can people develop the notion that a project is beneficial to them?</p>	
<p>Follow-Up Answer if Required:</p> <p>A1. There are many ways for leaders to develop the notion that a project is personally beneficial. They can get team members to discuss:</p> <ul style="list-style-type: none"> • personal interests and goals and relating those to aspects of the project. • past projects that they enjoyed and why they enjoyed them. • some of the benefits that they hope to realize by working on the project and the value of those benefits. 	
<p>Feasibility</p>	
<p>PREPARED QUESTIONS:</p> <p>Q1. Do you believe feasibility is the same for everyone? How does it differ between individuals?</p> <p>Q2. How does it affect the people's attitude towards a project? How do people react when they work on a project they believe is unfeasible in opposition to a project they believe is feasible?</p>	
<p>ANTICIPATED ANSWERS:</p> <p>A1. Of course, feasibility is a subjective assessment. What seems impossible to one person can appear feasible to another.</p> <p>A2. Assessment of feasibility can become a self-fulfilling prophecy. If people think an assessment is feasible, they will work hard to complete it; if they encounter problems, they will try to work them out. However, if people really believe they have no chance of succeeding, they give up at the first sign of difficulty. Any problems just confirm what they already knew — the project was doomed from the start. Of course, as soon as they give up, they have no chance of succeeding, so their initial belief is that the project wasn't feasible has been confirmed.</p>	

Prepared Content / Learning Objectives	Notes / Comments / Answers from the Guided Discussion for Summary
<p>No matter how desirable people may feel a project is, they will give up more easily when they encounter any difficulties if they are convinced that nothing they do can cause it to succeed. People do not need a guarantee of success, but they must believe they have a chance.</p>	
<p>Follow-Up Question if Required:</p> <p>Q1. How can people develop the notion that a project is feasible?</p>	
<p>Follow-Up Answer if Required:</p> <p>A1. People can develop the notion that a project is feasible by:</p> <ul style="list-style-type: none"> • identifying potential concerns to the leader and getting them addressed; or • having the leader explain why they feel that targets and plans are feasible. 	
<p>Progress</p>	
<p>PREPARED QUESTION:</p> <p>Q1. Why should people be informed of how they are progressing?</p>	
<p>ANTICIPATED ANSWER:</p> <p>A1. People have to know how they are doing over time for various reasons, such as:</p> <ul style="list-style-type: none"> • achieving intermediate milestones provides personal satisfaction; • recognizing their successes confirms they are on the right track; and • successfully completing intermediate steps reinforces their beliefs that they can accomplish the final goals. 	
<p>Follow-Up Questions if Required:</p> <p>Q1. How do you feel when someone takes some interest in the work you have done? That such and such an area needs improvement or that you have done a great job so far?</p> <p>Q2. Have you ever seen a three-month project where all the major milestones occur in the last 3–4 weeks? When do you think people get serious about the project?</p>	

Prepared Content / Learning Objectives	Notes / Comments / Answers from the Guided Discussion for Summary
<p>Q3. How could you have kept those people on track earlier in the process?</p> <p>Follow-Up Answers if Required:</p> <p>A1. Answers will vary.</p> <p>A2. People tend to wait until the last minute, when no other motivation comes their way.</p> <p>A3. Do the following to help keep people on track and excited about the project:</p> <ul style="list-style-type: none"> • establish meaningful and frequent intermediate milestones; • continually assess how people are doing; • frequently share information with people about their performance; and • continually reinforce the project's potential benefits. 	
<p>Recognition</p>	
<p>PREPARED QUESTION:</p> <p>Q1. What are forms of rewards that you can give people?</p>	
<p>ANTICIPATED ANSWER:</p> <p>A1. Rewards can take multiple forms, such as:</p> <ul style="list-style-type: none"> • talking with the person and expressing your appreciation; • expressing appreciation in a written note or email; • expressing appreciation in writing to the person's supervisor; • issuing the person a certificate of appreciation; and • taking the person out to lunch. 	
<p>Follow-Up Question if Required:</p> <p>Q1. What are ways to make those rewards most effective?</p>	
<p>Follow-Up Answers if Required:</p> <p>A1. To make the rewards most effective:</p> <ul style="list-style-type: none"> • be sure your acknowledgment and appreciation is honest and sincere. 	

Prepared Content / Learning Objectives	Notes / Comments / Answers from the Guided Discussion for Summary
<ul style="list-style-type: none">• respect the person's personal style and preferences when giving the reward:<ul style="list-style-type: none">○ Some people enjoy receiving acknowledgments in front of their peers, while others prefer receiving them in private.○ Some people appreciate receiving an individual award; others appreciate receiving an award presented to the entire team.	

THIS PAGE INTENTIONALLY LEFT BLANK



**COMMON TRAINING
PROFICIENCY LEVEL FIVE
INSTRUCTIONAL GUIDE**



SECTION 3

EO M503.03 – CONDUCT AN EXERCISE

Total Time:

60 min

PREPARATION

PRE-LESSON INSTRUCTIONS

Resources needed for the delivery of this lesson are listed in the lesson specification located in A-CR-CCP-805/PG-001, *Proficiency Level Five Qualification Standard and Plan*, Chapter 4. Specific uses for said resources are identified throughout the instructional guide within the TP for which they are required.

Review the lesson content and become familiar with the material prior to delivering the lesson.

PRE-LESSON ASSIGNMENT

Nil.

APPROACH

A group discussion was chosen for TPs 1 and 3 as it allows the cadets to interact with their peers and share their knowledge, experiences, and opinions about beginning and ending activities and supervision an activity.

An interactive lecture was chosen for TPs 2 and 4 to orient the cadets to how to begin and end an exercise and how to supervise an exercise.

INTRODUCTION

REVIEW

QUESTIONS:

- Q1. What is a project audience?
- Q2. What is the approach of dividing an item into its component parts to describe the details of a project?
- Q3. What is an important guideline to follow when assigning people tasks?
- Q4. What information needs to be included in a pre-exercise meeting?
- Q5. What are ways to encourage motivation?

ANTICIPATED ANSWERS:

- A1. A project audience is any person or group that supports, is affected by, or is interested in a project.
- A2. A work-breakdown-structure (WBS) is the approach of dividing an item into its component parts to describe the details of a project.
- A3. An important guideline to follow when assigning tasks is "Leaders should never assign other people tasks that they cannot clearly define themselves."
- A4. The information in a pre-activity meeting must include:
- what has to be done;
 - when it has to be done;
 - how it has to be done;
 - by whom it has to be done; and
 - available resources.
- A5. Motivation can be encouraged through:
- desirability,
 - feasibility,
 - progress, and
 - recognition.

OBJECTIVES

By the end of this lesson the cadet shall be expected to conduct an exercise.

IMPORTANCE

It is important for cadets to know how to conduct an exercise because monitoring and making changes as necessary are important steps in ensuring an exercise meets its goals. Also, announcing the activity at the appropriate time and holding a successful pre-exercise meeting allows people to prepare for the exercise.

Teaching Point 1**Have the cadets discuss how to begin and end an activity.**

Time: 10 min

Method: Group Discussion

BACKGROUND KNOWLEDGE

The point of the group discussion is to draw the following information from the group using the tips for answering / facilitating discussion and the suggested questions provided.

ELEMENTS OF AN INTRODUCTION

Always have the area set up, including placement of resources, prior to the arrival of participants. Ask the following questions before participants arrive:

- Are all the required resources in place?
- Does everyone involved in conducting the activity have a clear understanding of their responsibilities?
- Is there sufficient space?
- If applicable, can the weather be relied on? If not, is the backup plan ready and achievable?

Getting the team's attention. To introduce an activity, the leader first gets the attention of the team. The leader gets the team's attention before continuing to introduce the activity. If one cadet is not paying attention, they could miss an important point that could affect their participation in the activity or the activity's outcome.

Explaining the goal of the activity. The goal of the activity should be explained to the team in general terms of what will be learned or accomplished. The context of the activity should be explained so the cadets know why their participation is essential and why the activity is a part of the day's agenda. It is important not to give too much detail at this point, as the leader should draw some points on the purpose of the activity from the cadets after the activity's completion.

Explaining the activity. The activity must be explained to the team prior to participating in the activity. The rules of the activity must be clearly outlined and understood by all cadets prior to commencement. The leader should ensure the activity is clearly understood.

Assigning tasks as necessary. If any specific tasks need to be performed throughout the activity, the leader should assign cadets to these tasks during the introduction of the activity.

Setting time limits. The leader is to set a time limit for the cadets to participate in the activity. The leader must factor in time for debriefing the cadets after completion of the activity.

Relaying safety concerns as necessary. If there are any safety concerns, the leader must pass these on to the team prior to the start of the activity.

Motivating the team. Prior to the start of the activity, the leader must motivate the team. The leader should be enthusiastic and share this enthusiasm with the cadets. The goal of the activity is important and there is a reason the activity is being performed. The cadets should be informed of this reason and be motivated toward achieving the goal.

ELEMENTS OF A DEBRIEFING

Reviewing the goal. After the completion of an activity, it is important to review what the goal of that activity was with the cadets. Cadets always want to know why they had to participate in an activity or learn about a specific topic, so reinforce why the learning was important.

Providing feedback. The leader should first ask for feedback from the group on the activity. This can be done through some preset questions, specifically about the activity. It is important to find out how the cadets felt about the activity (eg, did they feel it was useful, did they learn anything from participating in the activity, etc). The leader gains valuable insight from the cadets on the activity itself (eg, if they would use it again, how it could be conducted differently, what elements of the activity they would not change if they did the activity again, etc). The most important information to elicit from the cadets is if they felt the activity was worthwhile. The leader must also give feedback to the cadets. Whether the goal was met is an important point to focus on during this stage. Why was the goal met or why not? Was the activity completed and did this have an effect on the goal being met? The leader should also give and get feedback on how the group interacted throughout the duration of the activity. The leader tells the cadets how they viewed the groups' interactions and ask how the cadets felt they interacted with each other.

Re-motivating the team. The final step in debriefing a group after an activity has been completed is to re-motivate the cadets.

GROUP DISCUSSION



TIPS FOR ANSWERING / FACILITATING DISCUSSION:

- Establish ground rules for discussion, eg, everyone should listen respectfully; don't interrupt; only one person speaks at a time; no one's ideas should be made fun of; you can disagree with ideas but not with the person; try to understand others as much as you hope they understand you; etc.
- Sit the group in a circle, making sure all cadets can be seen by everyone else.
- Ask questions that will provoke thought; in other words avoid questions with yes or no answers.
- Manage time by ensuring the cadets stay on topic.
- Listen and respond in a way that indicates you have heard and understood the cadet. This can be done by paraphrasing their ideas.
- Give the cadets time to respond to your questions.
- Ensure every cadet has an opportunity to participate. One option is to go around the group and have each cadet answer the question with a short answer. Cadets must also have the option to pass if they wish.
- Additional questions should be prepared ahead of time.

SUGGESTED QUESTIONS:

- Q1. What is the first thing you should do when starting an activity? Why?
- Q2. Should the goal of the activity be explained prior to commencing the activity? Why or why not? How will the activity be affected if the goal is not explained?
- Q3. What other considerations should be passed on during an introduction? Should safety concerns be passed on to the team or should they be left to figure them out as they proceed through the activity?
- Q4. What is the purpose of reviewing the goal of the activity after the completion of the activity?
- Q5. What feedback should be given from the group to the leader? How can this information be obtained? What feedback should the leader give to the group?



Other questions and answers will develop throughout the group discussion. The group discussion should not be limited to only those suggested.



Reinforce those answers given and comments made during the group discussion, ensuring the teaching point has been covered.

CONFIRMATION OF TEACHING POINT 1

The cadets' participation in the group discussion will serve as the confirmation of this TP.

Teaching Point 2

Explain how to begin and end an exercise.

Time: 5 min

Method: Interactive Lecture

Beginning and ending an exercise is very similar to beginning and ending an activity.



Ask the cadets to list actions that should be taken before cadets arrive.

Before cadets arrive, leaders should:

- inspect the exercise area for any damage or safety concerns;
- set up the exercise area; and
- ensure everyone involved has a clear understanding of their responsibilities.

When cadets arrive on grounds, leaders should hold an introductory meeting with the entire group to cover information that will be important throughout the exercise.



Ask the cadets to list information that should be included in an introductory meeting.

The introductory meeting should include information, such as:

- welcome to the participants,
- introduction of staff members,
- general outline of the exercise,
- safety concerns (eg, slippery floor, out-of bound areas, etc.),
- location of facilities (eg, washrooms, canteen, classes, gym, etc.),
- muster area in case of emergency, and
- first aid station.

At the end of the exercise, leaders should hold a conclusion meeting with the entire group to cover information that was relevant to the exercise.



Ask the cadets what information could be included in a conclusion meeting.

The conclusion meeting should include information, such as:

- conduct of the exercise (eg, competition winners);
- feedback from the instructors;
- feedback from the cadets; and
- recognition to individual or group contribution.



If leaders want more detailed feedback, they could get the cadets to write their feedback and submit it at the next training session.

After the cadets have left, leaders should:

- inspect the exercise area for any damage or safety concerns;
- tear down the exercise area;
- return stores.

Any damage to the exercise area or to the equipment need to be reported to the appropriate authority (eg, Training Officer, Commanding Officer, building management, Supply Officer, school administration, etc.).



One way to simplify the conclusion of an exercise is to include it in the WBS because it allows people to observe the importance of the final steps and maintain focus to the tasks that need to be carried out. It also ensures sufficient time and resources have been allocated for those activities to be performed.

CONFIRMATION OF TEACHING POINT 2

QUESTIONS:

- Q1. What are things that should be completed prior to the cadets' arrival?
- Q2. What information should be included in an introductory meeting?
- Q3. What information could be included in a conclusion meeting?

ANTICIPATED ANSWERS:

- A1. Prior to the cadets' arrival, leaders should:
- inspect the exercise area has for any damage or safety concerns;
 - set up the exercise area; and
 - ensure everyone involved has a clear understanding of their responsibilities.
- A2. The introductory meeting should include information, such as:
- welcome to the participants,
 - introduction of staff members,
 - general outline of the exercise,
 - safety concerns (eg, slippery floor, out-of bound areas, etc.),
 - location of facilities (eg, washrooms, canteen, classes, gym, etc.),
 - muster area in case of emergency, and
 - first aid station.
- A3. The conclusion meeting should include information, such as:
- conduct of the exercise (eg, competition winners);
 - feedback from the instructors;
 - feedback from the cadets; and
 - recognition to individual or group contribution.

Teaching Point 3**Have the cadets review supervising an activity.**

Time: 5 min

Method: Group Discussion

BACKGROUND KNOWLEDGE

The point of the group discussion is to draw the following information from the group using the tips for answering / facilitating discussion and the suggested questions provided.



Cadets should have previous knowledge on the subject as this was taught in EO M303.05 (Supervise Cadets).

THE PURPOSES OF SUPERVISION

There are three main purposes of supervision.

To provide protection. Supervision ensures the safety and well-being of personnel. Safety is the number one issue in every aspect of the Cadet Program. When situations are not safe, they are stopped immediately. CATO 14-31, *Director Cadets and Junior Canadian Rangers General Safety Program*, outlines the requirements for a general safety program that must be incorporated in every aspect of cadet activities.

To provide support. Supervision ensures that all members of the team are assisted, provided for and encouraged during tasks. If cadets are not practicing intrapersonal management, interpersonal management, teamwork and effective communication, the supervisor must act on the situation.

To provide quality assurance. Supervision ensures the outcomes of a task meet expectations for that task. If cadets are not meeting their responsibilities in completing the task, the supervisor must act on the situation. No one likes to be over-supervised. It is important not to micromanage the team.

HOW TO SUPERVISE

As leaders, cadets are expected to supervise others. Supervision takes place during the entire task, not just at the beginning or end of the task. Although each situation where supervision takes place is unique, there are some common responsibilities that must be fulfilled. Leaders shall meet these responsibilities by:

Ensuring safety. Ensuring that every situation in the Cadet Program is carried out in a safe manner is the primary concern of all members involved.

Ensuring the well-being of cadets. The welfare of cadets within the Cadet Program is a primary concern in the execution of all training and administrative tasks.

Encouraging cadets. Encourage cadets to produce satisfactory work because they want to. Inspiring results through praise creates a positive outcome.

Adjusting responsibilities as required. Being able to adjust a cadet's responsibilities during tasks is important. Cadets with experience may need less supervision and may be given extra responsibilities.

Maintaining control of cadets. Keep cadets on task while they are producing satisfactory work. An effective supervisor is able to keep cadets focused.

Correcting errors as required. If mistakes are made, effective supervisors communicate this. They revise what and how it needs to be done and remedy errors.

Reporting misconduct as required. When cadets behave in a manner that is inconsistent with the core leadership qualities of a cadet, these behaviours should be reported up the chain of command.

Ensuring completion of responsibilities assigned to cadets as required. When supervisors delegate or assign tasks to others, it is the supervisor's responsibility to ensure all delegated tasks are completed.



Successful supervisors are usually successful leaders.

GROUP DISCUSSION



TIPS FOR ANSWERING / FACILITATING DISCUSSION:

- Establish ground rules for discussion, eg, everyone should listen respectfully; don't interrupt; only one person speaks at a time; no one's ideas should be made fun of; you can disagree with ideas but not with the person; try to understand others as much as you hope they understand you; etc.
- Sit the group in a circle, making sure all cadets can be seen by everyone else.
- Ask questions that will provoke thought; in other words avoid questions with yes or no answers.
- Manage time by ensuring the cadets stay on topic.
- Listen and respond in a way that indicates you have heard and understood the cadet. This can be done by paraphrasing their ideas.
- Give the cadets time to respond to your questions.
- Ensure every cadet has an opportunity to participate. One option is to go around the group and have each cadet answer the question with a short answer. Cadets must also have the option to pass if they wish.
- Additional questions should be prepared ahead of time.

SUGGESTED QUESTIONS:

- Q1. What are the purposes of supervision? When does supervision take place?
- Q2. What do you think the responsibilities of an effective supervisor are?
- Q3. Which responsibility do you find the most important? Why?
- Q4. Which responsibility do you find the most difficult to apply? Why?
- Q5. List some examples where you have seen leaders use various responsibilities.



Other questions and answers will develop throughout the group discussion. The group discussion should not be limited to only those suggested.



Reinforce those answers given and comments made during the group discussion, ensuring the teaching point has been covered.

CONFIRMATION OF TEACHING POINT 3

The cadets' participation in the group discussion will serve as the confirmation of this TP.

Teaching Point 4

Explain how to supervise an exercise.

Time: 5 min

Method: Interactive Lecture

Supervising an exercise is very similar to supervising an activity.



Ask the cadets to list the three main purposes of supervision.

There are three main purposes to supervision:

- to provide protection;
- to provide support; and
- to provide quality assurance.

The same way cadets are supervised by activity leaders, activity leaders should be supervised by exercise leaders. When exercise leaders are supervising, they should:

- ensure completion of tasks;
- ensure the activity leaders are providing challenging, fun and safe training;
- stop an activity when it is deemed unsafe; and
- provide guidance to activity leaders.

PROVIDING FEEDBACK

Guidance should be provided to activity leaders at the appropriate time and in an appropriate manner.



Ask the cadets to list the principles of effective feedback. The material was taught in more details during EO M403.04 (Provide Feedback to Team Members).

Feedback may be given to the team as a whole or it may be given to individual team members. Giving feedback well is a skill. When giving feedback, it should be:

- frequent,
- accurate,
- specific,
- timely.



Ask cadets to list the ground rules for providing feedback. The material was taught in more details during EO M403.04 (Provide Feedback to Team Members).

The following ground rules for providing feedback may enable the team leader to give helpful, constructive feedback, without creating conflict or confrontational behaviour with team members.

The ground rules are:

- focusing on what is observed;
- focusing on behaviour;
- keeping it neutral;
- using it to inform;
- making it supportive; and
- keeping it simple.



Ask cadets to list the steps for providing feedback. The material was taught in more details during EO M403.04 (Provide Feedback to Team Members).

The purpose for providing feedback is to let team members know how they are doing and when they are not meeting expectations. Leaders should ensure that feedback is given when team members meet and / or exceed their commitments, as well as when team members do not meet their commitments. There are five steps for providing feedback:

- planning what to say;
- providing examples of behaviours;
- allowing time for feedback;

- motivating; and
- setting a timeline for action and follow-up.

CONFIRMATION OF TEACHING POINT 4

QUESTIONS:

- Q1. What are the three main purposes to supervision?
- Q2. What should exercise leaders do when supervising?
- Q3. What are the ground rules to providing feedback?

ANTICIPATED ANSWERS:

- A1. There are three main purposes to supervision:
- to provide protection;
 - to provide support; and
 - to provide quality assurance.
- A2. When exercise leaders are supervising, they should:
- ensure completion of tasks;
 - ensure the activity leaders are providing challenging, fun and safe training;
 - stop an activity when it is deemed unsafe; and
 - provide guidance to activity leaders.
- A3. The ground rules are:
- focusing on what is observed;
 - focusing on behaviour;
 - keeping it neutral;
 - using it to inform;
 - making it supportive; and
 - keeping it simple.

END OF LESSON CONFIRMATION

QUESTIONS:

- Q1. What elements should be included in an activity introduction?
- Q2. What are actions leaders should take prior to cadets' arrival on an exercise?
- Q3. What are the five steps for providing feedback?

ANTICIPATED ANSWERS:

A1. Elements that should be included in an activity introduction are:

- getting the team's attention;
- explaining the goal of the activity;
- explaining the activity;
- assigning tasks as necessary;
- setting time limits;
- relaying safety concerns as necessary; and
- motivating the team.

A2. Prior to cadets' arrival, leaders should:

- inspect the exercise area for any damage or safety concerns;
- set up the exercise area; and
- ensure everyone involved has a clear understanding of their responsibilities.

A3. The five steps for providing feedback are:

- planning what to say;
- providing examples of behaviours;
- allowing time for feedback;
- motivating; and
- setting a timeline for action and follow-up.

CONCLUSION

HOMEWORK / READING / PRACTICE

Nil.

METHOD OF EVALUATION

This EO is evaluated IAW A-CR-CCP-805/PG-001, *Proficiency Level Five Qualification Standard and Plan*, Chapter 3, Annex B, 503 PC.

CLOSING STATEMENT

Once an exercise begins, there may be changes that need to be made. It is important for cadets to recognize the importance of supervising the activity to ensure it reaches its goals, goes as planned, and if not, that the appropriate changes are made.

INSTRUCTOR NOTES / REMARKS

Cadets shall be given the opportunity to conduct an exercise, as a member of a group, as part of their OJT.

REFERENCES

Nil.



**COMMON TRAINING
PROFICIENCY LEVEL FIVE
INSTRUCTIONAL GUIDE**



SECTION 4

EO M503.04 – CONCLUDE AN EXERCISE

Total Time:

30 min

PREPARATION

PRE-LESSON INSTRUCTIONS

Resources needed for the delivery of this lesson are listed in the lesson specification located in A-CR-CCP-805/PG-001, *Proficiency Level Five Qualification Standard and Plan*, Chapter 4. Specific uses for said resources are identified throughout the instructional guide within the TP for which they are required.

Review the lesson content and become familiar with the material prior to delivering the lesson.

Make an OHP of Attachment A.

PRE-LESSON ASSIGNMENT

Nil.

APPROACH

An interactive lecture was chosen for TP 1 to orient the cadets to the conclusion of an exercise, the content of an after action report and the conduct of a debriefing.

An in-class activity was chosen for TP 2 as it is an interactive way to provoke thought and stimulate interest about after action report.

INTRODUCTION

REVIEW QUESTIONS:

- Q1. What are the elements in an activity debriefing?
- Q2. What actions have to be completed by exercise leaders after the cadets' departure?
- Q3. List the supervision responsibilities that a leader should meet.

ANTICIPATED ANSWERS:

- A1. The elements in an activity debriefing should include:
 - reviewing the goal;
 - providing feedback; and
 - re-motivating the team.

A2. After the cadets have left, leaders should:

- inspect the exercise area for any damage or safety concerns;
- tear down the exercise area;
- return stores.

A3. The supervision responsibilities that a leader should meet are:

- ensuring safety;
- ensuring the well-being of cadets;
- encouraging cadets;
- adjusting responsibilities as required;
- maintaining control of cadets;
- correcting errors as required;
- reporting misconduct as required; and
- ensuring completion of responsibilities assigned to cadets as required.

OBJECTIVES

By the end of this lesson the cadet shall be expected to conclude an exercise.

IMPORTANCE

It is important for cadets to conclude an exercise as it is an important step in project management. Recognizing areas for improvement and successes will allow people to take this knowledge into their next project and improve its chances for success.

Teaching Point 1**Explain the steps in the conclusion of an exercise.**

Time: 10 min

Method: Interactive Lecture

CONDUCTING A DEBRIEFING

Having a debriefing with the personnel involved in the exercise is a crucial step in identifying the practices to keep and the practices to avoid in future projects from the experience gained during the current project. The people involved in the project can, by sharing their experiences, observations and suggestions, help a leader recognize the achievements and areas for improvement encountered during the various planning and conducting stages of the exercise.

Like any meeting, the debriefing should be preceded by an agenda that may include:

- purpose of the debriefing,
- goals of the activity or activities,
- highlights, such as:
 - results, schedules, and resources,
 - tracking systems and procedures,
 - communications, and
 - practices and effectiveness;
- discussion and recognition of special achievements,
- review of reactions to the activity (cadets or supervisors),
- discussion of problems and issues, or
- discussion of how to reflect experiences from this project in future efforts.

During the debriefing, the following issues should be discussed:

- what was accomplished and individuals' contributions;
- techniques and approaches that worked to ensure they will be used in the future;
- techniques and approaches that did not work to ensure they are not used in the future, or they are used only following appropriate adjustments.

Here are a few things to keep in mind when planning a debriefing:

Invite the right people. Invite people that were involved. If the list is too long, decide to meet with the subgroups, then hold a general session where everyone reviews the results of the smaller meetings and where final comments and suggestions are made.

Ensure everyone understands the purpose of the meeting is to learn, not to blame. The post project evaluation is a means to examine what has been done to improve it.

If anyone starts to attack or criticize other participants, the discussion needs to be brought back to order. This can be done by asking questions, such as:

- What can you yourself do in the future to deal more effectively with such situations?
- What can we do in the future to prevent such situations from occurring?

It can also be done by having personnel:

- identify what others did well; or
- examine their own performance and see how they could have handled situations differently.



Be sure to assign a person to take notes during the debriefing. Those notes will be useful when writing the after action report (AAR).

CREATING AN AFTER ACTION REPORT (AAR)

As soon as possible after the debriefing, prepare and distribute an AAR based on notes from the briefing.

The AAR should include the following information:

- practices to incorporate in future projects,
- steps to take to encourage these practices,
- practices to avoid on future projects, and
- steps to be taken to avoid these practices.



After (and during if possible) the completion of a project, recognize the individuals or groups who helped "make it happen". Whether it be announcements or a thank you to who made it possible, recognizing those who worked hard is important.

CONFIRMATION OF TEACHING POINT 1

QUESTIONS:

- Q1. What has to be accomplished after the conduct of an exercise?
- Q2. What is the importance of the debriefing?
- Q3. What elements are found in an AAR?

ANTICIPATED ANSWERS:

- A1. After the conduct of an exercise, ensure the following tasks are completed:
 - a tear down of the area,
 - return of resources,

- debriefing, and
 - AAR.
- A2. Having a debriefing with the people involved in the exercise is a crucial step in identifying the practices to keep and the practices to avoid in future projects from the experience gained during the current project.
- A3. The following elements are found in an AAR:
- practices to incorporate in future projects,
 - steps to take to encourage these practices,
 - practices to avoid on future projects, and
 - steps to be taken to avoid these practices.

Teaching Point 2

Conduct an activity where the cadets develop an after action report format.

Time: 15 min

Method: In-Class Activity

ACTIVITY

Time: 15 min

OBJECTIVE

The objective of this activity is to have the cadets develop their own AAR format.

RESOURCES

- Flip chart paper, and
- Markers.

ACTIVITY LAYOUT

Nil.

ACTIVITY INSTRUCTIONS

1. Divide the class into two groups.
2. Distribute a flip chart paper and markers to each group.
3. Tell the cadets they have to create a template for an AAR that must contain all the necessary information.
4. Allow the cadets eight minutes to work on the assignment.
5. Allow each group two minutes to present their work.
6. Have the cadets reflect on which format they prefer.

SAFETY

Nil.



Show the cadets Attachment A for an example of an AAR format that could be used.

CONFIRMATION OF TEACHING POINT 2

The cadets' participation in the activity will serve as the confirmation of this TP.

END OF LESSON CONFIRMATION

The cadets' conclusion of an activity will serve as the confirmation of this lesson.

CONCLUSION

HOMEWORK / READING / PRACTICE

Nil.

METHOD OF EVALUATION

This EO is evaluated IAW A-CR-CCP-805/PG-001, *Proficiency Level Five Qualification Standard and Plan*, Chapter 3, Annex B, 503 PC.

CLOSING STATEMENT

It is important to properly close out an activity as the mistakes and success of an activity can be used when planning the next one. Leaders have to recognize the importance of taking a few moments to reflect on the learning experience from the activities they prepare and conduct.

INSTRUCTOR NOTES / REMARKS

Cadets shall be given the opportunity to conclude an exercise, as a member of a group, as part of their OJT.

REFERENCES

C3-252 ISBN 978-0-470-04923-5 Portny, S. E. (2007). *Project management for dummies*. Hoboken, NJ: Wiley Publishing.

AFTER ACTION REPORT

EVENT: _____

	SITUATION	SOLUTIONS & RECOMMENDATIONS
1. Training		
a. Time allocation	The time allocated for EO MXXX.XX was insufficient. Instructors did not have time to complete the class and had to leave out the last TP.	The class may be completed during a regular training night. Allow two periods for this class in next year's training schedule.
b.
2. Support		
a. Transportation
b. Facilities	The facilities were great. There was a sufficient number of classrooms for the number of lessons to be carried out. Having showers available was very useful. The fact that cadets had a chance to freshen up after the sports event was very appreciated by all.	Keep the same facilities for a similar event in the future.
3. Other		
a.
b.
c.
4. Other		
a.
b.

By: _____

THIS PAGE INTENTIONALLY LEFT BLANK



**COMMON TRAINING
PROFICIENCY LEVEL FIVE
INSTRUCTIONAL GUIDE**



SECTION 5

EO C503.01 – EXAMINE MEETING PROCEDURES

Total Time:

90 min

PREPARATION

PRE-LESSON INSTRUCTIONS

Resources needed for the delivery of this lesson are listed in the lesson specification located in A-CR-CCP-805/PG-001, *Proficiency Level Five Qualification Standard and Plan*, Chapter 4. Specific uses for said resources are identified throughout the self-study package within the section for which they are required.

Self-study packages are intended to be completed by the cadet independently. More information about self-study packages can be found in the foreword and preface.

Review the lesson content and become familiar with the material prior to facilitating this lesson.

Photocopy the self-study package located at Attachment A for the cadet.

Photocopy the answer key located at Attachment B but **do not** provide it to the cadet.

For the final exercise located at the end of the self-study package, obtain a copy of an actual exercise plan or operations order (ops order) used by the squadron or photocopy the sample exercise located at Attachment C for the cadet.

PRE-LESSON ASSIGNMENT

Nil.

APPROACH

A self study was chosen for this lesson as it allows the cadet to examine meeting procedures at their own learning pace. This encourages the cadet to become more self-reliant and independent by focusing on their own learning instead of learning directed by the instructor.

INTRODUCTION

REVIEW

Nil.

OBJECTIVES

By the end of this lesson the cadet shall have examined meeting procedures.

IMPORTANCE

It is important for cadets to examine meeting procedures as the squadron will be participating in meetings to create proposals and prepare / conduct / conclude exercises.

SELF-STUDY PACKAGE INSTRUCTIONS

OBJECTIVE

The objective of this self-study package is to have the cadet examine meeting procedures.

RESOURCES

- Self-study package, and
- Pen / pencil.

ACTIVITY LAYOUT

Provide the cadet with a classroom or training area suitable to complete the self-study package.

ACTIVITY INSTRUCTIONS

1. Provide the cadet with a copy of the self-study package located at Attachment A and a pen / pencil.
2. Allow the cadet 90 minutes to complete the self-study package.
3. Provide assistance as required to the cadet.
4. Collect the self-study package once the cadet has finished.
5. Correct the self-study package with the self-study package answer key located at Attachment B.
6. Provide feedback to the cadet and indicate whether or not they have completed the Enabling Objective (EO).
7. Return the completed self-study package to the cadet for their future reference.
8. Record the result in the cadet's logbook and Cadet Training Record.

SAFETY

Nil.

END OF LESSON CONFIRMATION

The cadet's completion of the self study package will serve as the confirmation of this lesson.

CONCLUSION

HOMEWORK / READING / PRACTICE

Nil.

METHOD OF EVALUATION

Nil.

CLOSING STATEMENT

By examining meeting procedures, you will have a better understanding of the benefits of meetings and on how to facilitate them to ensure their success.

INSTRUCTOR NOTES / REMARKS

This self study shall only be completed after the mandatory component of PO 503 (Lead Cadet Activities).

REFERENCES

A0-010 CATO 11-03 Director Cadets 2. (2006). *Cadet program mandate*. Ottawa, ON: Department of National Defence.

A0-201 United States Army Medical Department Battle Simulation Center (2003). *Military briefings*. Retrieved February 26, 2010 from http://www.cs.amedd.army.mil/simcenter/military_briefings.htm

C0-004 ISBN 1-58062-577-0 McClain, G., & Romaine, D. S. (2002). *The everything managing people book*. Avon, MA: Adams Media.

C0-021 ISBN 1-58062-513-4 Adams, B. (2001). *The everything leadership book*. Avon, MA: Adams Media.

C0-022 ISBN 0-02864-207-4 Cole, K. (2002). *The complete idiot's guide to clear communications*. USA: Pearson Education, Inc.

C0-112 ISBN 0-8407-6744-7 Maxwell, J. C. (1993). *Developing the leader within you*. Nashville, TN: Thomas Nelson Inc. Publishers.

C0-113 ISBN 1-882664-12-4 Karnes, F. A., & Bean, S. M. (1995). *Leadership for students: A practical guide for ages 8–18*. Waco, TX: Prufrock Press.

C0-114 ISBN 0-02-863656-2 Pell, A. R. (1999). *The complete idiot's guide to team building*. Indianapolis, IN: Alpha Books.

C0-115 ISBN 0-7879-4059-3 van Linden, J. A., & Fertman, C. I. (1998). *Youth leadership*. San Francisco, CA: Jossey-Bass Inc., Publishers.

C0-144 Colver, E., & Reid, M. (2001). *Peacebuilder 3: Peer helping participant resource guide*. Ottawa, ON: YouCAN.

C0-245 ISBN 1-58062-513-4 Adams, B. (2001). *The everything leadership book*. Avon, MA: Adams Media.

C0-256 ISBN 0-7894-4863-7 Heller, R. (1999). *Achieving excellence*. New York, NY: DK Publishing, Inc.

C0-270 Maslow, A. H. (1943). A theory of human motivation. *Psychological Review*, Vol. 50(4), 370–396.

C0-271 Farthing, D. (2001). *Peacebuilder 1: Conflict resolution youth reference guide*. Ottawa, ON: YouCAN.

C0-410 The ASPIRA Association. (2009). *Module #5: Defining leadership styles*. Retrieved on February 12, 2009, from http://www.aspira.org/files/documents/youthdev08/U_V_M_5_dls.pdf

C0-413 University of Arkansas, Division of Agriculture, Cooperative Extension Service. (2006). *4-H volunteer leaders' series: The enabler—A leadership style*. Retrieved February 18, 2009, from http://www.uaex.edu/other_areas/publications/PDF/4HCD2.pdf

C0-468 ISBN 0-06-091573-0 Hamlin, S. (1989). *How to talk so people listen*. New York, NY: Harper & Row Publishers.

C0-469 ISBN 1-57851-143-7 Argyris, C., Bartolomé, F., Bourgeois, L. J., III, Eisenhardt, K. M., Jay, A., Kahwajy, J. L., et al. (1999). *Harvard business review on effective communication*. Boston, MA: Harvard Business School Publishing.

C3-251 ISBN 978-0-306-81354-2 Robert, H. M., III, Evans, W. J., & Honemann, D. H. (2004). *Robert's rules of order: Newly revised in brief*. New York, NY: Perseus Books Group.

THIS PAGE INTENTIONALLY LEFT BLANK

Examine Meeting Procedures



SECTION: 1 IDENTIFY TYPES OF MEETINGS

SECTION: 2 EXAMINE HOW TO ORGANIZE MEETINGS

SECTION: 3 EXAMINE HOW TO FACILITATE MEETINGS

SECTION 1 IDENTIFY TYPES OF MEETINGS

TYPES OF MEETINGS

There are many types of meetings, such as two friends meeting over coffee or a session of the House of Commons. The two types of meetings that will be described here are the ones used most often within the Cadet Program: briefings and committee meetings.

BRIEFING

A briefing is a type of meeting used to convey what needs to be done during an exercise or to inform the participants of an activity and of the necessary details. There is little input from the group except asking clarifying questions.

Briefing. A meeting for delivering information or instructions.



As a cadet, a briefing is the most common type of meeting you would be expected to facilitate.

As a cadet, there are two types of briefings you may be asked to facilitate:

- **Information briefing.** The information briefing is intended to inform the listeners and to gain their understanding. The briefing deals primarily with facts. The briefer provides a brief introduction to define the subject and to orient the listener and then presents the information.
- **Staff briefing.** The staff briefing is intended to secure a coordinated or unified effort. This may involve the exchange of information, the making / announcement of decisions, the issuance of directives, or the presentation of guidance. The staff briefing may include characteristics of an information briefing.

Functions of a Briefing

A briefing needs to be clear, concise, and complete. It needs to be tailored to its audience; a briefing for the activity leaders of an exercise is different from the one you would give to the cadets participating in the exercise.

- **Communicating the overall plan.** Explain how the exercise will be carried out. Always include safety details that affect the whole exercise (eg, fire orders, muster points, first aid personnel, and boundaries). All team members should know what is involved. This may include identifying various stages and phases.
- **Communicating the tasks involved in the leadership appointment.** Explain the tasks involved within the exercise.
- **Assigning tasks to team members as applicable.** Assign team members tasks that must be completed within the scope of the exercise. Every team member should be actively engaged in a meaningful activity.
- **Ensuring the team members understand their tasks.** Confirm team members understand their tasks and ask the team members if they have any questions. The team leader should also ask questions of various team members to ensure comprehension. When team members are assigned specific tasks, it is important they understand what is expected of them.



Think about questions you could ask or actions you could take to ensure everyone has understood their tasks.

COMMITTEE MEETING

A committee meeting is used to plan and organize an exercise. Members' participation is necessary for this type of meeting to be successful.

Committee meeting. A group of people, nominally up to 12 members, headed by a chairperson, meeting for discussion and debate on subjects relevant to its members.



Now that you know that members' participation is necessary in a committee meeting, how would you ensure maximum participation in your meeting?

During your time in cadets, most of the meetings you have attended were briefings. Younger cadets have little input in the planning and organization of the activities in which they participate. As you have progressed through the Cadet Program, the tasks that you have been assigned to complete have progressed from leading a small group of cadets in setting up a classroom to leading a flight on parade.

Functions of a Committee Meeting

Meetings fulfill many functions for the team. The functions of a meeting include:

- defining the team;
- providing an opportunity where the team revises, updates, and adds to what it knows as a team;
- helping everyone to understand the collective aim of the team and the way in which their work contributes to the team's success;
- creating a commitment to the decisions it makes and the objectives it pursues; and
- creating an occasion where the team physically exists and works **as a group**, and the only time when the leader is the leader of the team and not just a person to whom individuals are responsible to.

Objective(s) of a Meeting

There are many reasons to have meetings. As part of Proficiency Level Five you will participate in meetings to create proposals and prepare / conduct / conclude exercises as part of PO 503 (Lead Cadet Activities). Here are some meeting objectives:

- **Legislative framework.** The objective of the meeting is to clarify the organizational makeup of the team; its rules, routines and procedures (eg, who is responsible to whom, how problems should be addressed, what tasks need to be completed) through which all action takes place.
- **Executive responsibilities.** The objective of the meeting is to determine who will be responsible for what tasks. Each member sees what others are doing and also understands how their roles / responsibilities fit into the whole project / exercise.
- **Constructive / originative.** The objective of the meeting is to guide a discussion where the knowledge, experience, judgment and ideas of the team are used to come up with or think through a proposal, project, exercise, etc.
- **Informative / digressive.** The objective of the meeting includes progress reports—to keep the team up-to-date on the current status of the tasks—and a review of the completed project to see what can be learned for the next time (eg, a meeting used to determine details of an After Action Report).

SECTION 2

EXAMINE HOW TO ORGANIZE MEETINGS

HOW TO ORGANIZE A BRIEFING

To organize your briefing, you will need the complete activity or exercise plan. It should state the who, what, where and when of the briefing.



Tell them what **they** need to know, **not** all **you** know!

Organizing a briefing requires four steps:

1. **Analyze the situation.** This includes analyzing the audience and the occasion by determining:
 - Who is to be briefed and why?
 - How much knowledge of the subject does the audience have?
 - What is expected of the briefer?
2. **Construct the briefing.** The construction of the briefing will vary with its type and purpose. The analysis provides the basis for this determination. The following are the major steps in preparing a briefing:
 - a. Know the subject thoroughly.
 - b. Isolate the key points.
 - c. Arrange the key points in logical order.
 - d. Select visual aids, if required.
 - e. Establish the wording.
 - f. Rehearse before a knowledgeable person who can critique the briefing.
3. **Deliver the briefing.** A successful briefing is dependent on how it is presented. A confident delivery, clearly enunciated and obviously based on full knowledge of the subject helps convince the audience. The briefer maintains a relaxed, but professional bearing using natural gestures and movement, but avoiding distracting mannerisms. The delivery is characterized by conciseness, objectivity, and accuracy. The briefer must be aware of the following:
 - The basic purpose is to present the subject as directed and to ensure that it is understood by the audience.
 - Brevity precludes a lengthy introduction or summary.
 - Interruptions and questions may occur at any point. If these interruptions occur, the briefer answers questions before proceeding or should indicate that questions will be answered later in the briefing. Do not permit questions to distract you from your planned briefing. If the question will be answered later in the briefing, the briefer should make specific reference to the earlier question when introducing that material. The briefer should anticipate possible questions and be prepared to answer them.
4. **Follow-up.** Ensure an understanding of the material. When the briefing is over, the briefer should elicit the opinion of a peer or superior for a critique.

HOW TO WRITE A BRIEFING

The following is a format used when writing an information briefing.

The Information Briefing

The information briefing should follow this format:

1. The introduction, to include:
 - a. greeting,
 - b. purpose and scope, to include:
 - (1) giving the big picture first; and
 - (2) explaining the purpose and scope of your briefing; and
 - c. outline or procedure, to include:
 - (1) summarizing the key points and your general approach; and
 - (2) explaining any special procedures (eg, demonstrations).
2. The body, to include:
 - a. arranging the main points in a logical sequence;
 - b. using visual aids to emphasize your main points;
 - c. planning effective transitions from one main point to the next; and
 - d. being prepared to answer questions at any time.
3. The closing, to include:
 - a. asking for questions;
 - b. summarizing the key points and making a concluding statement; and
 - c. announcing what will be happening next.

What to Consider When Writing a Staff Briefing

The staff briefing should include:

1. **General.** The staff briefing is an information briefing presented to the staff who are leading the activities or responsible for completing tasks for the exercise.
2. **Purposes of a staff briefing.** Give specific instructions, if required. The staff briefing serves to:
 - issue or elaborate on the exercise plan;
 - instil a general appreciation of the exercise;
 - review the key points of the exercise plan; and
 - ensure participants know the exercise's objective(s), problems that may arise, and ways to overcome them.
3. **Format.** A staff briefing is normally informal and has no set format.



Activate Your Brain #1:

What are the four steps when organizing a briefing?

HOW TO ORGANIZE A MEETING

During EO M503.02 (Prepare an Exercise), a basic procedure on how to plan a pre-exercise meeting was described. The following (more formal and detailed) procedures on how to organize and facilitate a meeting are from *Robert's Rules of Order: Newly Revised in Brief*, more commonly known as Robert's Rules of Order.



Did you know?

When Henry Martyn Robert (an officer in the United States Army) was asked to preside over a church meeting, he realized he did not know how. He tried anyway and his embarrassment was supreme. This event, which may seem familiar to many, left him determined never to attend another meeting until he knew something about parliamentary law. He studied the books that were available on the subject, but soon realized that every part of the United States had differing ideas of the correct procedure. To bring order to the chaos, he decided to write *Robert's Rules of Order* (first published in 1876) which quickly became the most commonly used procedures for facilitating meetings in the country.

Duties of the Chairperson

It is the responsibility of the chairperson for all planning for a meeting, which includes:

- setting the timings for the meeting;
- creating the agenda;
- running the meeting;
- supervising debate;
- conducting any voting; and
- creating the minutes.

Setting the Timings for the Meeting

Team members shall be notified of meetings as soon as possible to allow the meeting to be more productive and allow all members to express their concerns.

Creating the Agenda

Every meeting must first be convened. This process should begin with an agenda. The most critical priority for a meeting must always be to avoid wasting members' time. An effective agenda is the best tool for that purpose.

The agenda structures the order of business for a meeting and is a guide for attendees to follow. When setting the agenda, think of it as a set of rules for a good meeting.

The agenda must provide the organization's name, the date, time and place of the meeting. It should also give a finish time and, where possible, an approximate time for each item, so that the chairperson can keep an effective rein on the meeting by using the time framework.

Standard agenda items and their suggested order are:

1. confirmation of the minutes from the previous meeting;
2. matters arising from the previous minutes (any matter that was raised at the previous meeting which needed follow-up action on a carried motion);
3. correspondence in and out;
4. reports (these could be from the team's various departments); and
5. general business (brief background information on agenda topics as required).

The chairperson can vary the order of business at the meeting if the meeting members agree.



An agenda is more effective if given to the members before the meeting rather than at the meeting.

Running the Meeting

All business is brought before the assembly in the form of a motion. Before members can make a motion or address the assembly they must obtain the floor using the following protocol:

1. The members will raise their hand and wait to be recognized.
2. The chairperson is addressed by title, "Mr. Speaker" or "Madame Speaker".
3. The member introducing a motion has the first right to the floor.
4. Members who have not spoken to a motion shall have precedence over those who have.
5. The chairperson must recognize any member who seeks the floor while entitled to it.
6. Before a motion is open to debate it must (if required) be seconded and stated by the Speaker after which it is open to debate.
7. All important motions and amendments shall be in writing.
8. After the Speaker has stated a motion it is the property of the assembly and can only be withdrawn with unanimous consent or permission of the assembly.

Debate

Speeches shall conform to the following rules:

- Maximum speech length, as determined by assembly, will be respected.
- Decorum in debate will be maintained, to include:
 - remarks must be confined to the merits of the pending question;
 - attacks on a member's motives are not allowed;
 - all remarks must be addressed through the chairperson;

- the use of members' names will be avoided;
 - refrain from speaking against one's own motion;
 - stop speaking during an interruption by the chairperson; and
 - refrain from disturbing the assembly.
- The chairperson is not to take part in the debate.
 - When possible, the chairperson shall alternate the debate between those for and those against the motion.

Voting

Voting, if required, shall conform to the following rules:

- Procedures for voting shall be as the chairperson suggests.
- A member can change their vote until the time that the result is announced.
- A straw poll (an unofficial ballot taken as a test of opinion) is not in order for official purposes; a formal vote is required.



Did you know?

For a vote to be valid, a quorum must exist.

Quorum. The fixed minimum number of members that must be present to make the proceedings of an assembly, society, or meeting valid.

Creating the Minutes

Minutes. A brief summary of the proceedings of a meeting.

Minutes should be taken by someone other than the chairperson. This allows the chairperson to concentrate on facilitating the meeting. Minutes shall contain enough information to:

- maintain an accurate historical account of a meeting held; and
- allow for a clear understanding of the business that was conducted for those present and not present.

As a guideline, minutes should contain the following information:

- name of body, associated office, department or organization;
- date, time and location of the meeting;
- the list of attendees, guests and regrets (including the chairperson, and recording secretary);



Regrets. Expressing polite apologies for not being able to attend a meeting.

Members who cannot attend the meeting contact the chairperson with their reasons. The chairperson informs the recording secretary of those members who have sent regrets to distinguish them from members who did not contact the chairperson about their absence.

- a record of all motions that were presented;
- a clear distinction between open and closed sections of the meeting;
- consecutively numbered pages (use a header with meeting name, date, and page number);
- time of adjournment; and
- list of titles of any reports presented during the meeting.



Principles for effective minute-taking:

- **BEFORE** the meeting:
 - If possible, meet with the chairperson to set the agenda.
 - Learn what is expected to be included in the meeting minutes.
 - Use the agenda to make an outline for recording purposes.
 - Make sure there is a backup recording tool (eg, if taking minutes using a laptop computer, having pen and paper available if there are problems).
 - Make an extra copy of the agenda and / or materials to bring to the meeting.
 - Read and review all meeting materials.
 - Prepare an attendance sheet (know who is expected to attend and who sent regrets).
- **DURING** the meeting:
 - When possible, sit next to the meeting chairperson.
 - Follow the sequence of the meeting using the agenda.
 - Listen actively.
 - Focus on documenting the main ideas, processes and outcomes.
 - Record all motions and results (if not clear on the wording, ask for the motion to be repeated).
- **AFTER** the meeting, compose the minutes as follows:
 - If needed, ask the chairperson for clarification on any issues discussed.
 - Draft the minutes as soon as possible, while everything is still fresh.
 - Include only factual and concise statements about each issue discussed.
 - Omit unnecessary details.
 - Record in the past tense and in the third person.
 - Proofread, and then have the chairperson proofread.
 - Ensure the minutes, and amendments if required, are available for approval at the next meeting.



Activate Your Brain #2:

What are the duties of the chairperson?

SECTION 3

EXAMINE HOW TO FACILITATE MEETINGS

FACILITATING THE MEETING

Remember the objective of the meeting and stay on track. The two most important things for this to happen are the agenda (for dealing with the subject) and the actions of the chairperson (for dealing with the people).

Dealing With the Subject

When planning the agenda, the placement or order of items to be discussed can be very helpful for dealing with the subject of the meeting.

For example, you could:

- place smaller items first on the agenda to build up a sense of success before dealing with the main item;
- place the main item first to ensure it is discussed, leaving the smaller items to be decided after or at another meeting; or
- place a contentious item last so it can not potentially disrupt the entire meeting.

Dealing With the People

Dealing with people is an important skill, especially when you are in a position of leadership. Chairpersons need to build trust between themselves and their followers. There are six critical areas:

- **Communication.** Must always be a two-way street.
- **Support.** Being approachable, helpful, and concerned, especially when things are not going well.
- **Respect.** A question of delegating authority and listening to what subordinates have to say.
- **Fairness.** Giving credit and assessing blame where they are due.
- **Predictability.** Being dependable and keeping promises.
- **Competence.** Knowing your own job and doing it well.

Leadership is influence and influence is exercised through communication. Like any skill, competent communication must be learned and developed over a lifetime. Communication skills permit the flow of ideas from one individual to another or to a group, and vice versa. The process of communication can include both verbal and non-verbal messages. Understanding the three styles of communication aids you when facilitating a meeting by knowing who to watch out for (aggressive), who to draw out (passive) and who to support (assertive).

The ability of the team to work during a meeting is determined by their ability to work together. This is the primary task of the chairperson. Your conduct, both verbal and non-verbal, will set the tone for the meeting.

LEADERSHIP APPROACHES

There are three main leadership approaches discussed in the Cadet Program. They are:

- control,
- coach, and
- empower.

Each leadership approach is based on balancing the concern for the relationship with team members for the concern for accomplishing the goal(s) of the meeting.

All leadership approaches may be required when facilitating a meeting. You have to rely on your training and experience to help you decide which approach is best for a given situation.



As a chairperson, this can be the most difficult part in running a meeting. Often, getting everyone to participate can be a challenge.

MEETINGS: WHAT CAN GO WRONG AND WHY

When you have a group of people together at a meeting, anything can happen. A **poorly** facilitated meeting quickly reinforces the idea that meetings are a waste of time. The following definitions describe how members may act / feel during meetings.

Passivity. The members are only attending because they have to. They feel that they have little to no input into the overall plan.

Boring. Most of the meeting has nothing to do with most of the members, so why are they here? The only part of the meeting that interests the member is theirs!

People don't listen. Listening is a skill and many people are poor listeners. This is understandable as people think faster than they can talk, creating down time for their brain; when listening to others the brain "fills" this down time between the speaker's words with their own thoughts. Another reason people don't listen is the subject; other members' ideas are not as good as theirs so why listen?

Grandstanding. Sometimes one or two members seem to dominate the discussion. This grandstanding has the effect of overwhelming the younger, less experienced and less aggressive members.

The power of the leader. It's hard to disagree with the leader. If you, as the chairperson, are seen as favouring one idea, the members are less likely to challenge / disagree with it.

Foregone conclusions. Members feel that a meeting is a waste of time if it appears the chairperson has already made a decision.

Not useful. Members' past experiences of finishing a meeting left them not sure exactly what was decided and what they are to do next. This gives them the opinion that the meeting was a waste of time.

Fear of exposure. If members talk about their ideas or express opinions, they expose themselves to public criticism. This can be devastating to a young person, especially when such criticism is done by someone they respect.

Potential conflict. Most people prefer to get along with others. When you disagree with someone, there is the potential for conflict. Members who disagree may feel isolated or unpopular and opt instead for the safety of silence. Also, some people enjoy provoking conflict and these people need to be watched out for.

Prior relationships brought to the meeting. Members who associate together are seen by other members as a clique. Such cliques are seen as supporting their own members, even over the good of the team. If there is more than one clique, there is a potential for rivalry to overshadow the meeting.

Concern about consequences. What will be required of the members when an idea is accepted? Will some members have to do more than others? What are the consequences of not being able to do my part? This anxiety can make attending a meeting a very unpleasant experience for some members.



Have you experienced any of the situations described above? What is your opinion about attending a meeting?

MEETINGS: WHY THEY ARE IMPORTANT

With all these problems is it even worth the effort to have meetings? Before you can make this decision, here are some of the reasons why meetings are important.

Getting a sense of the whole. So much work is done by individuals or small groups that it becomes vital for the team to see the big picture. This gives everyone a sense that their work is part of the plan, helping build morale and esprit de corps.

Comparing notes. By comparing notes, problems affecting one member may be solved by another member who had a similar problem.

Sharing information. Learning what others have done, hearing ways similar problems were solved, and being able to share something learned all builds toward a positive outcome for the meeting and the team.

Being visible to each other. Much of the team's work is done by individuals or small groups, so it can be difficult to actually be a team. Being together in a meeting allows the energy of the members to synergize the members into a team. It also allows the leader to be seen as a leader and not just someone that you report to.

Comfort of hearing others' opinions openly. It can be very uncomfortable discussing ideas and opinions one-on-one with the leader. However, if this is done by everyone as a team, there is less anxiety due to the fact that everyone is in the same boat. Such openness also create a norm of acceptable discussion.

Looking for solutions jointly. The saying "two heads are better than one" emphasizes the concept that there is usually more than one way to do something. Sometimes members get so caught up in their own thoughts and ideas that they don't see all the ways something can be done.

Group self-critique. If problems are aired by self-critique (eg, you talk about problems **you** are having), and everyone is doing it, it is easier to discuss the problems in a non-conflictive manner. By bringing up your own problems, you are trusting in the team to help you solve them. This also builds morale and esprit de corps.

Developing consensus. If there is consensus, the team as a whole gains a sense of ownership to the exercise. If everyone is in agreement, conflicts are resolved through solving the problem, not attacking the one who saw the problem.

Stimulating ideas. The atmosphere of the team focusing on one idea brings the creative level up for all the members. Discussing possible solutions stimulates other members to add to the idea to make it better.



In your opinion, why are meetings important?

THINGS TO WATCH OUT FOR DURING THE MEETING

As you have read, facilitating a meeting draws heavily on leadership principles and skills. The following are things to watch out for during the meeting.

Control the talkative. Some people can take a very long time to say very little. Remember, your meeting needs to stay on track. First try non-verbal cues (eg, staring the speaker in the eye) and, if necessary, verbal ones (eg, taking over the conversation by moving the discussion on) to control the talkative speaker.

Draw out the silent. Everyone's input is important, otherwise why are they at the meeting? However, for various reasons, most people remain silent throughout a meeting. People who are included in the planning / preparation of the project will usually work to make it successful.



Activate Your Brain #3:

For the following phrases, which style of communication (aggressive / passive / assertive) do they most resemble?

Control the talkative

Draw out the silent

Protect the timid. The input of the younger / less experienced members of the group may provoke disagreement with their seniors, which is reasonable. However, if the disagreement escalates to personal attacks or suggestions that the younger / less experienced members should not contribute ideas, the morale of the team will quickly deteriorate. Successful participation in a productive meeting builds confidence for all, especially the younger / less experienced members.

Encourage the clash of ideas. If the goal is to have the best outcome, then all ideas need to be thoroughly discussed. However, this may become a clash of personalities (between those whose ideas are being discussed) instead of the ideas. As chairperson, you need to keep the tone of the discussion professional. Keep the discussion on the ideas, not the people promoting them.

Watch out for the suggestion-squashing reflex. If people feel that making a suggestion will provoke the negative reaction of being laughed at or squashed, they will soon stop suggesting ideas. This can be most destructive if it is done by the chairperson! Instead, take notice of all suggestions, especially if it is suggested by a younger / less experienced member of the team.

Come to the most senior people last. This serves several purposes. It allows the younger / less experienced members of the team the experience of participating in the discussion. It also allows these younger / less experienced members to present their ideas before hearing the ideas of the older / more experienced members.



Remember when you were the younger / less experienced member of a team? Did you experience anxiety when you were teamed with older / more experienced cadets?

Close on a note of achievement. Making a meeting worth the effort means ensuring that it is seen as a success. At the end of the meeting, make it a point of emphasizing all that was accomplished. Remember, as chairperson, it is your responsibility to ensure the meeting was a success!



Congratulations, you have completed your self-study package on EO C503.01 (Examine Meeting Procedures). Complete the following exercise and hand the completed package to the Training / Proficiency Level Officer and have them record the completion in your Proficiency Level Five Logbook.

**FINAL EXERCISE
PREPARE A BRIEFING**

Using the information briefing format, create a briefing for the provided exercise plan (Item #4 on the timetable).

Note. If there are more than five key points, use blank paper to complete.

INTRODUCTION

Greeting: _____

Purpose and Scope:

Give the big picture first. _____

Explain the purpose and scope of your briefing. _____

Outline or Procedure:

Briefly summarize the key points and your general approach. _____

Explain any special procedures (eg, demonstrations). _____

BODY

Point #1: _____

Visual Aid? No Yes Description: _____

Possible Questions: _____

Transition: _____

Point #2: _____

Visual Aid? No Yes Description: _____

Possible Questions: _____

Transition: _____

Point #3: _____

Visual Aid? No Yes Description: _____

Possible Questions: _____

Transition: _____

Point #4: _____

Visual Aid? No Yes Description: _____

Possible Questions: _____

Transition: _____

Point #5: _____

Visual Aid? No Yes Description: _____

Possible Questions: _____

Transition: _____

CLOSING

Ask for Questions

Briefly recap key points:

Point #1: _____

Point #2: _____

Point #3: _____

Point #4: _____

Point #5: _____

Make a Concluding Statement:

Announce What Will Be Happening Next:

THIS PAGE INTENTIONALLY LEFT BLANK

ACTIVATE YOUR BRAIN ANSWER KEY



Activate Your Brain #1:

What are the four steps when organizing a briefing?

Analyze the situation.

Construct the briefing.

Deliver the briefing.

Follow-up.



Activate Your Brain #2:

What are the duties of the chairperson?

- **setting the timings for the meeting**
- **creating the agenda**
- **running the meeting**
- **supervising debate**
- **conducting any voting**
- **creating the minutes**



Activate Your Brain #3:

For the following phrases, which style of communication (aggressive / passive / assertive) do they most resemble?

Control the talkative **aggressive**

Draw out the silent **passive**

GUIDELINES FOR MARKING THE FINAL EXERCISE

When marking the final exercise, the following points should be considered:

- Is it legible?
- Are all sections complete?
- Could another person use this briefing effectively?

INTRODUCTION

- Did the cadet state their name in the greeting?
- Is the purpose and scope of the briefing explained?

BODY

- Are all key points of the exercise plan covered?
- Are all points organized in a logical order?
- Are all points clear and concise?
- Are visual aids planned?
 - If no, should a visual aid(s) have been planned?
 - If yes, was it appropriate?
- Are possible questions prepared for?
 - If no, have the cadet explain why not?
 - If yes, are they appropriate?
- Are transitions planned between points?

CLOSING

- Are all points recapped?
- Is the concluding statement motivational?
- Is the happening next announcement correct?

EXERCISE PLAN EXAMPLE

TITLE OF THE EXERCISE: SPORTS EVENT: OPERATION GET-YOUR-MOVE-ON

WHAT

Unit 123 Moncton will participate in Operation GET-YOUR-MOVE-ON, a sports event to be conducted at the Moncton Everblue High School on Saturday, 10 Mar 2012 from 0900 hrs–1600 hrs.

WHY

Unit 123 Moncton will conduct the sports event to promote physical fitness amongst all cadets, to introduce them to various sports, and to develop leadership and refereeing skills in senior cadets. The event will take place over one day to allow the conduct of multiple sports.

HOW

A. General Outline

Example: This exercise will be conducted in five phases:

1. Phase One – Administration

The pre-activity meeting will be conducted on 21 Feb 12 in the CO's office at 1730 hrs. All members will attend. Booking of facilities, administrative preparation and planning are being completed by the Training Officer.

2. Phase Two – Preparation of Facilities

Prior to the cadets' arrival, all sergeants are required to prepare the facilities. The equipment for all sports events is to be taken out of the supply room and placed in the appropriate area. Signs identifying bathrooms, water points, and safety points have to be put up. This should be completed NLT 0840 hrs.

3. Phase Three – Conduct of the Exercise

As per schedule. Will include exercise / safety briefing, warm-up, conduct of the sports, lunch, cool-down and activity debriefing. Cadets will be allowed to leave at 1600 hrs.

4. Phase Four– Return of Stores

Return of stores, clean-up of facilities.

5. Phase Five - Post-exercise meeting

Post-exercise meeting will be conducted on Sunday 11 Mar 2012 at the CO's office from 1700 hrs to 1830 hrs. All senior cadets and officers will attend.

B. Groupings

Cadets will be divided upon arrival into four different sports teams. WO1 Mackey will ensure this is done as soon as cadets are on ground.

C. Tasks

WHO	TASKS
Capt Malloy	<ul style="list-style-type: none"> • Plan the sports event. • Book school facilities. • Deliver the safety briefing upon arrival. • Deliver the event's debriefing.
Lt Nixon	<ul style="list-style-type: none"> • Responsible for meal arrangements. • Responsible for all medical emergencies. First-aider for the event.
WO1 Mackey	<ul style="list-style-type: none"> • Responsible to ensure that equipment and signs are ready before 0840 hrs as per Annex C. • Responsible to ensure all activities are carried out safely and according to the timetable. • Responsible to have cadets divided into four sports teams.
WO2 Landry	<ul style="list-style-type: none"> • Responsible for the training and evaluation of all activity referees. • Offer feedback to activity referees. • Complete and submit an individual evaluation of all referees to the Training Officer.
FSgt Gagnon	<ul style="list-style-type: none"> • Responsible for the evaluation all activity referees. • Offer feedback to activity referees. • Complete and submit an individual evaluation of all referees to the Training Officer.
Sgt Penny	<ul style="list-style-type: none"> • Responsible for equipment set-up and tear-down • Become familiar with and referee soccer. • Become familiar with and referee volleyball.
Sgt Randell	<ul style="list-style-type: none"> • Responsible for equipment set-up and tear-down. • Become familiar with and referee soccer. • Become familiar with and referee volleyball.
Sgt Picard	<ul style="list-style-type: none"> • Responsible for equipment set-up and tear-down. • Become familiar with and referee ball hockey. • Become familiar with and referee badminton.
Sgt Clark	<ul style="list-style-type: none"> • Responsible for equipment set-up and tear-down. • Become familiar with and referee ball hockey. • Become familiar with and referee badminton.
Sgt Belliveau	<ul style="list-style-type: none"> • Responsible for set-up and tear-down. • Responsible to carry out the warm-up and the cool-down. • Responsible for the tug-of-war event.
All members	<ul style="list-style-type: none"> • All members are to look after safety. • Anything deemed unsafe should be stopped right away and rectified.

D. Timings

See timetable in Annex A.

E. Dress

Dress for the event will be suitable sports gear. No outdoor footwear shall be worn inside.

F. Rations

Rations will be arranged by Lt Nixon.

G. Accommodations

Arrangements for the school are to be made by Capt Malloy.

H. Equipment

See Annex B for Equipment List.

See Annex C for Activity Layout.

I. Transport

Cadets are responsible for their own transportation to and from the school.

J. Emergency Procedures

All medical emergencies will be reported to Lt Nixon. First aid will be available on site, and will be given if necessary. Medical emergencies will be directed to 911.

K. Water

Water will be available at school fountains. All cadets are to bring a personal water bottle to have water on hand.

L. Hygiene

The school washrooms (toilets and showers) will be available.

CHAIN OF COMMAND

Planning: Capt Malloy

Conduct: WO1 Mackey

Evaluation: WO2 Landry, FSgt Gagnon

Rations: Lt Nixon

First-Aider: Lt Nixon

Referees: Sgt Penny, Sgt Randell, Sgt Picard, Sgt Clark and Sgt Belliveau

Capt R Malloy

TrgO

123 Moncton

A-CR-CCP-805/PF-001
Attachment C to EO C503.01
Instructional Guide

Distribution List

CO
DCO
Capt Malloy
Lt Nixon
WO1 Mackey
WO2 Landry
FSgt Gagnon
Sgt Penny
Sgt Randell
Sgt Picard
Sgt Clark
Sgt Belliveau

List of Annexes

Annex A - Timetable
Annex B - Equipment
Annex C - Exercise Layout

Annex A

TIMETABLE

Period	Time	What	Who	Comments
1	0810–0840 hrs	Set-up	All Sergeants	
2	0840–0900 hrs	Cadets arrival	All senior cdt's	
3	0900–0905 hrs	Attendance		
4	0905–0920 hrs	Exercise briefing	**YOU**	WO1 to divide teams at this time.
5	0920–0930 hrs	Warm up	Sgt Belliveau	
6	0940–1010 hrs	Game 1	Sgt Randell Sgt Penny	Soccer (Teams 1 vs 2) Volleyball (Teams 3 vs 4)
7	1010–1030 hrs	Break		
8	1030–1100 hrs	Game 2	Sgt Penny Sgt Randell	Soccer (Teams 1 vs 3) Volleyball (Teams 2 vs 4)
9	1100–1120 hrs	Break		
10	1120–1200 hrs	Game 3	TBD*	Soccer (Teams 3 vs 4) Volleyball (Teams 1 vs 2)
11	1200–1300 hrs	Lunch		
12	1300–1330 hrs	Game 4	Sgt Picard Sgt Clark	Hockey (Teams 1 vs 2) Badminton (Teams 3 and 4)
13	1330–1350 hrs	Break		
14	1350–1420 hrs	Game 5	Sgt Clark Sgt Picard	Hockey (Teams 3 vs 4) Badminton (Teams 1 and 2)
15	1420–1440 hrs	Break		
16	1440–1510 hrs	Game 6	TBD*	Hockey (Teams 1 vs 4) Badminton (Teams 2 and 3)
17	1510–1535 hrs	Tug of war	Sgt Belliveau	
18	1535–1545 hrs	Cool down	Sgt Belliveau	
19	1545–1600 hrs	Debriefing	Capt Malloy	
20	1600 hrs	Departure	All senior cdt's	

* Based on previous experience of both sports, determine who may need more practice and assign as appropriate.

Annex B

EQUIPMENT LIST

- Hockey sticks x 20
- Hockey masks x 20
- Hockey gloves x 20
- Protective goggles x 20
- Hockey nets x 2
- Pucks x 2
- Badminton rackets x 20
- Badminton birds x 6
- Badminton sets (nets and poles) x 3
- Pinnies x 20 of each colour (2 colours)
- Volleyball set (nets and poles) x 1
- Volleyball ball x 2
- Large 18-m (60-foot) rope x 1
- First aid kit x 2

Annex C

EXERCISE LAYOUT

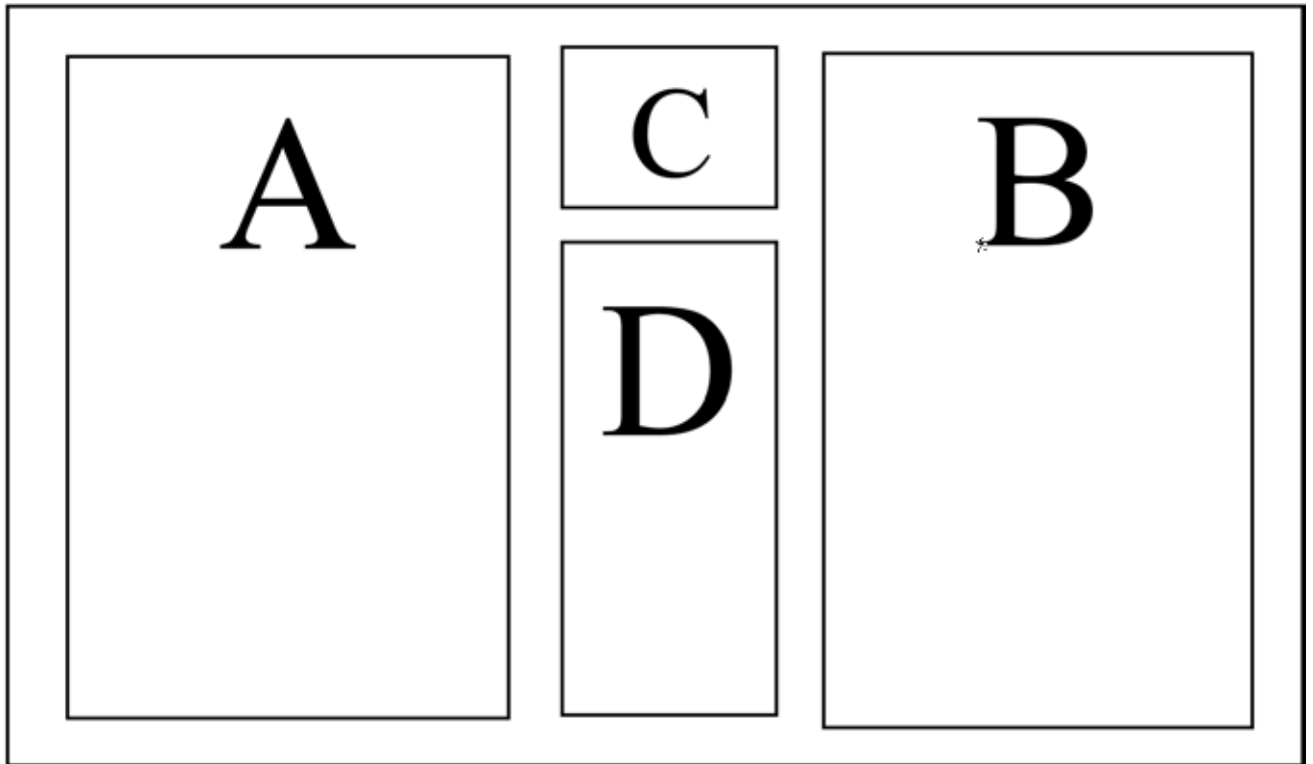

Legend:

A: Soccer / Hockey

B: Volleyball / Badminton

C: First Aid Station

D: Tug of War

THIS PAGE INTENTIONALLY LEFT BLANK



**COMMON TRAINING
PROFICIENCY LEVEL FIVE
INSTRUCTIONAL GUIDE**



SECTION 1

**EO M504.01 – PARTICIPATE IN THE CADET FITNESS ASSESSMENT AND
IDENTIFY STRATEGIES FOR IMPROVING PERSONAL PHYSICAL FITNESS**

Total Time:

One session (3 periods) = 90 min

PREPARATION

PRE-LESSON INSTRUCTIONS

This IG supports EO M504.01 (Participate in the Cadet Fitness Assessment and Identify Strategies for Improving Personal Physical Fitness) located in A-CR-CCP-805/PG-001, *Royal Canadian Air Cadets Proficiency Level Five Qualification Standard and Plan*, Chapter 4.

Review CATO 14-18, *Cadet Fitness Assessment and Incentive Program* and become familiar with the material prior to delivering the lesson.

Photocopy the *Individual Score Sheet for the 20-m Shuttle Run Test* located at CATO 14-18, Annex A, Appendix 1 for each cadet.

Photocopy the *Cadet Fitness Assessment and Incentive Level Results* located at CATO 14-18, Annex B, Appendix 3 for each cadet.

Photocopy the Strategies to Improve my Personal Physical Fitness handout located at Annex A for each cadet.

Photocopy Annex B for each assistant instructor.

Refer to the warm-up and the cool-down located at Annexes A and B of EO MX04.01 (Participate in 60 Minutes of Moderate- to Vigorous-Intensity Physical Activity and Track Participation in Physical Activities) for TP 1.

Gather cadets' previous CFA results for use in TP 2.

PRE-LESSON ASSIGNMENT

Nil.

APPROACH

A practical activity was chosen for this lesson as it allows the cadets to participate in the CFA in a safe and controlled environment.

INTRODUCTION

REVIEW

Nil.

OBJECTIVES

By the end of this lesson the cadet shall have participated in the CFA, identified which component of fitness needs the most improvement, identified strategies to improve that component of physical fitness, and set a SMART goal to help improve their personal physical fitness.

IMPORTANCE

It is important for the cadets to participate in the Cadet Fitness Assessment to measure their personal fitness as this will allow them to identify their strengths and their weaknesses. That information will allow cadets to identify strategies and set goals that will guide them towards a healthier lifestyle.

Teaching Point 1**Supervise while the cadets participate in the Cadet Fitness Assessment.**

Time: 60 min

Method: Practical Activity



If cadets have not already received their Physical Activity Tracker, distribute one copy to each cadet and explain the requirements for Proficiency Level Five: achieve a minimum of 60 minutes of MVPA daily for at least 24 days over four consecutive weeks.

ACTIVITY

The Cadet Fitness Assessment shall be conducted IAW CATO 14-18, *Cadet Fitness Assessment and Incentive Program*.

OBJECTIVE

The objective of this activity is to have the cadets participate in the Cadet Fitness Assessment.

RESOURCES

- CATO 14-18, *Cadet Fitness Assessment and Incentive Program*,
- Leger 20-m Shuttle Run Test CD,
- Measuring tape,
- CD player,
- Pylons,
- Gym mats,
- 12-cm measuring strips,
- Stopwatches,
- Paper,
- Pens / pencils,
- Metre sticks,
- *Back-saver sit and reach* test apparatuses, and
- *Individual Score Sheet for the 20-m Shuttle Run Test*.

ACTIVITY LAYOUT

Set up the activity IAW CATO 14-18.

ACTIVITY INSTRUCTIONS

1. Have the cadets participate in a warm-up session as per Annex A of EO MX04.01 (Participate in 60 Minutes of Moderate- to Vigorous-Intensity Physical Activity and Track Participation in Physical Activities).
2. Have the cadets perform and score the Cadet Fitness Assessment IAW CATO 14-18.



Have the cadets complete the Cadet Fitness Assessment in pairs. Conduct the 20-m Shuttle Run Test first; conduct the remaining stations as a circuit.

3. Have the cadets participate in a cool-down session as per Annex B of EO MX04.01 (Participate in 60 Minutes of Moderate- to Vigorous-Intensity Physical Activity and Track Participation in Physical Activities).

SAFETY

- Ensure a designated first-aider and first aid kit are available.
- Ensure water is available for the cadets throughout this activity.

CONFIRMATION OF TEACHING POINT 1

The cadets' participation in the Cadet Fitness Assessment will serve as the confirmation of this TP.

Teaching Point 2

Conduct an activity where the cadets identify how to improve their personal physical fitness.

Time: 30 min

Method: Practical Activity

ACTIVITY

OBJECTIVE

The objective of this activity is to have the cadets identify how to improve their personal physical fitness.

RESOURCES

- Cadet Fitness Assessment and Incentive Level Results from EO MX04.02 (Identify Strategies to Improve Participation in Physical Activities and Participate in the CFA), and
- Strategies to Improve My Personal Fitness handout located at Annex A.

ACTIVITY LAYOUT

Nil.

ACTIVITY INSTRUCTIONS

1. Distribute the Strategies to Improve My Personal Fitness handout located at Annex A to each cadet.
2. Have each cadet review their Cadet Fitness Assessment and Incentive Level Results and complete the Strategies to Improve My Personal Fitness handout.

3. With the help of assistant instructors, discuss each cadet's individual results with them and assist them with completing the handout.



A list of example physical activities cadets can do to improve their personal fitness is located at Annex B.

SAFETY

Nil.

CONFIRMATION OF TEACHING POINT 2

The cadets' participation in the activity will serve as the confirmation of this TP.

END OF LESSON CONFIRMATION

The cadets' participation in the activity will serve as the confirmation of this lesson.

CONCLUSION

HOMEWORK / READING / PRACTICE

Nil.

METHOD OF EVALUATION

Nil.

CLOSING STATEMENT

The Cadet Fitness Assessment is a great tool that can help you determine how physically fit you are in the three components of physical fitness (cardiovascular endurance, muscular strength, and muscular flexibility). Knowing where you need to improve will help you target your efforts.

INSTRUCTOR NOTES / REMARKS

The purpose of the Cadet Fitness Assessment is to have cadets measure their personal fitness to help them set individual goals for improvement. Each of the three components of fitness (cardiovascular, muscular strength, and muscular flexibility) are measured, and cadets are assessed using criterion-referenced standards as to whether they are in the healthy fitness zone (HFZ) within each of these components.

The HFZ is the level of fitness needed for good health. Cadets who do not fall within the HFZ for certain components should be coached and encouraged to set goals that will help them improve towards achieving the HFZ in the future.

The Cadet Fitness Assessment shall be set up prior to conducting this EO.

Assistant instructors will be required for this lesson.

The Cadet Fitness Assessment shall be conducted IAW CATO 14-18.

REFERENCES

CATO 14-18 Director Cadets 3. (2010). *Cadet fitness assessment and incentive program*. Ottawa, ON: Department of National Defence.

Meredith, M., & Welk, G. (Eds.). (2005). *Fitnessgram / activitygram: Test administration manual (3rd ed.)*. Windsor, ON: Human Kinetics.

The Cooper Institute. (n.d.). *Fitnessgram / activitygram test administration kit: Fitnessgram 8.0 stand-alone test kit*. Windsor, ON: Human Kinetics.



STRATEGIES TO IMPROVE MY PERSONAL PHYSICAL FITNESS

1. Based on CFA results, which component of fitness do I need to improve the most?

Cardiovascular Endurance?

Muscular Strength?

Muscular Flexibility?

2. What physical activities could I do on a regular basis to help me improve that component of fitness?

3. Set a SMART goal to help improve that component of fitness.

THIS PAGE INTENTIONALLY LEFT BLANK

PHYSICAL ACTIVITIES CADETS CAN DO TO IMPROVE THEIR PERSONAL FITNESS

Examples of physical activities that can help to improve the **cardiovascular endurance component**:

- aerobics,
- basketball,
- cross-country skiing,
- dancing,
- floor hockey,
- hiking,
- ice skating,
- lacrosse,
- orienteering,
- ringette,
- rollerblading,
- running,
- skipping rope,
- snowshoeing,
- soccer, and
- ultimate Frisbee.

Examples of physical activities that can help improve the **muscular strength component**:

- balance ball exercises,
- Pilates,
- resistance exercises using bands,
- resistance exercises using the body,
- weighted ball exercises,
- weighted bar exercises, and
- yoga.

Examples of physical activities that can help improve the **muscular flexibility component**:

- stretching,
- tai chi, and
- yoga.

THIS PAGE INTENTIONALLY LEFT BLANK



**COMMON TRAINING
PROFICIENCY LEVEL FIVE
INSTRUCTIONAL GUIDE**



SECTION 1

EO C504.01 – REFLECT ON PERSONAL FITNESS AND HEALTHY LIVING

Total Time:

One session (3 periods) = 90 min

PREPARATION

PRE-LESSON INSTRUCTIONS

This self-study package supports EO C504.01 (Reflect on Personal Fitness and Healthy Living) located in A-CR-CCP-805/PG-001, *Royal Canadian Air Cadets Proficiency Level Five Qualification Standard and Plan*, Chapter 4.

Self-study packages are intended to be completed by the cadet independently. More information about self-study packages can be found in the forward and preface.

Photocopy the self-study package located at Annex A for the cadet.

Photocopy the answer key located at Annex B but **do not** provide it to the cadet.

PRE-LESSON ASSIGNMENT

Nil.

APPROACH

A self study was chosen for this lesson as it allows the cadet to reflect on and examine in greater detail the key concepts related to physical fitness and healthy living, at their own learning pace. This encourages the cadet to become more self-reliant and independent by focusing on their own learning instead of learning directed by the instructor.

INTRODUCTION

REVIEW

Nil.

OBJECTIVES

By the end of this lesson the cadet shall have reflected on and examined in greater detail the key concepts related to physical fitness and healthy living.

IMPORTANCE

It is important for cadets to have a solid understanding of the components of healthy living as they move into further life stages.

SELF-STUDY PACKAGE INSTRUCTIONS

OBJECTIVE

The objective of this self-study package is to have the cadet reflect on and examine in greater detail the key concepts of physical fitness and healthy living.

RESOURCES

- Self-study package, and
- Pen / pencil.

ACTIVITY LAYOUT

Provide the cadet with a classroom or training area suitable to complete the self-study package.

ACTIVITY INSTRUCTIONS

1. Provide the cadet with a copy of the self-study package located at Annex A, the results of their Cadet Fitness Assessments (CFA) from Years 1 to current, and a pen / pencil.
2. Allow the cadet 90 minutes to complete the self-study package.
3. Provide assistance as required to the cadet.
4. Collect the self-study package once the cadet has finished.
5. Correct the self-study package with the self-study package answer key located at Annex B.
6. Provide feedback to the cadet and indicate whether or not they have completed the Enabling Objective (EO).
7. Return the completed self-study package to the cadet for their future reference.
8. Record the result in the cadet's logbook and Cadet Training Record.

SAFETY

Nil.

END OF LESSON CONFIRMATION

The cadet's participation in reflecting on and examining in greater detail the key concepts of physical fitness and healthy living will serve as the confirmation of this lesson.

CONCLUSION

HOMEWORK / READING / PRACTICE

Nil.

METHOD OF EVALUATION

Nil.

CLOSING STATEMENT

As cadets move from organized activities provided by cadet training to future education / work, the awareness of and actions related to healthy lifestyles become the individual's responsibility. With the greater examination of key concepts related to physical fitness and healthy living reviewed in the self-study package, cadets can be better prepared to pursue life-long habits of healthy living.

INSTRUCTOR NOTES / REMARKS

Nil.

REFERENCES

Canadian Mental Health Association (2013). *Your mental health*. Retrieved from <http://www.cmha.ca/mental-health/your-mental-health/>

Dieticians of Canada (2013). *Eat right Ontario: physical activity*. Retrieved from <http://www.eatrightontario.ca/en/Articles/Physical-Activity/>

Health-and-Fitness Source.com. (2012) *3 Ways your body is burning calories*. Retrieved March 15, 2013 from <http://www.health-and-fitness-source.com/burning-calories.html>

Health Canada (2011). *Estimated energy requirements*. Retrieved from http://hc-sc.gc.ca/fn-an/food-guide-aliment/basics-base/1_1_1-eng.php

Larson, Christian (2007). *Your forces and how to use them: The promise*. Retrieved from <http://www.goodreads.com/work/quotes/2208816-your-forces-and-how-to-use-them>

Mobile & Peruasive. (2008). *A brief survey of physical activity monitoring devices*. Retrieved from <http://www.icta.ufl.edu/projects/publications/chao08a.pdf>

Public Health Agency of Canada (2011). *Obesity in Canada. Determinants and contributing factors*. Retrieved from <http://www.phac-aspc.gc.ca/hp-ps/hl-mvs/oic-oac/determ-eng.php>

United States Department of Agriculture. (2011). *How many calories does physical activity use?* Retrieved from http://www.choosemyplate.gov/food-groups/physicalactivity_calories_used_table.html

World Health Organization. (2013). *Physical activity and adults*. Retrieved from http://www.who.int/dietphysicalactivity/factsheet_adults/en/index.html

THIS PAGE INTENTIONALLY LEFT BLANK



***REFLECT ON PERSONAL
FITNESS AND HEALTHY LIVING***

Section 1: Physical Fitness
Section 2: Nutritional Fitness
Section 3: Mental Fitness

SECTION 1 PHYSICAL FITNESS

According to CATO 11-03, *Cadet Program Mandate*, the Cadet Program aims to promote physical well-being. Cadets develop an understanding of the benefits of fitness and a healthy lifestyle. This understanding combined with on-going participation in fitness activities, aids in the development of positive attitudes and behaviours that build resiliency within cadets and enables them to meet challenges.

Throughout your participation in the Cadet Program, you have regularly participated in the Cadet Fitness Assessment (CFA), which has provided you with feedback on your level of fitness, allowing you to set goals to improve your fitness levels based on the results. In setting your goals, you used the SMART principles:

S	Specific	What specific activity can you do to help you reach your goal?
M	Measureable	How often will you do this? How much will you do? What will you track and how?
A	Achievable	What behaviour will you change and is the goal related to it achievable? What might hinder you as you progress towards the goal?
R	Relevant	What will you get out of this?
T	Timed	How long will it take you to reach your goal?

Example Goal: To be more active.	This goal will be hard to measure (what do you mean by “more”?) and needs a time frame (when will you start and finish?).
SMART Goal: To do vigorous physical activity for 60 minutes, 3 times a week for the next month.	This goal is specific, measureable and has a specific timeframe. This will help determine if you have reached your goal.

You have also used physical activity trackers for periods of time, to determine if you were meeting the *Canadian Physical Activity Guidelines* and the *Canadian Sedentary Behaviour Guidelines*.

You will recall that vigorous-intensity physical activities will cause teens to sweat and be ‘out of breath’. (eg, activities like running and rollerblading), while moderate-intensity physical activities will cause teens to sweat a little and to breathe harder (eg, activities like skating and bike riding).

Sedentary behaviour is time when you are doing very little movement. Some examples include: sitting for long periods, using motorized transportation, watching television, playing passive video games, and playing on the computer.

COMPONENTS OF PHYSICAL FITNESS

You have learned that there are 3 components of physical fitness, and that being physically fit requires you to include activities in each of the components on a regular basis. The three components of physical fitness are:

- cardiovascular endurance,
- muscular strength, and
- muscular flexibility.



Review your Cadet Fitness Assessments, from the first one to the current one. Based on your results, what changes can you observe in each of the 3 components of fitness?

Component	Decrease	No Change	Some Improvement	Substantial Improvement
Cardiovascular endurance				
Muscular strength				
Muscular flexibility				



List the physical activities you currently participate in under the correct component of physical fitness.

Cardiovascular Endurance	Muscular Strength	Muscular Flexibility

Are you participating in activities involving each of the components of physical fitness?

If your answer is YES – keep up the involvement!

If your answer is NO – what can you do to balance your physical activity?

ACTIVITY GUIDELINES FOR YOUTH

Examine the *Canadian Physical Activity Guidelines* and *Canadian Sedentary Behaviour Guidelines* located at Appendix 1 to answer the following questions:



Q1. What are the physical activity guidelines for Youth ages 12–17years?



List the physical activities you participated in to meet this guideline requirement, indicating (✓) if they were moderate or vigorous intensity activities.

Activity	Moderate	Vogorous



Q2. What are the sedentary behaviour guidelines for youth ages 12–17 years?



List the sedentary activities you have reduced in order to meet these guidelines.

Remember that being active for at least 60 minutes daily can help teens:

- Improve their health
- Do better in school
- Improve their fitness
- Grow stronger
- Have fun playing with friends
- Feel happier
- Maintain a healthy body weight
- Improve their self-confidence
- Learn new skills

ACTIVITY GUIDELINE CHANGES FROM YOUTH TO ADULT

Overall, strong evidence demonstrates that compared to less active adult men and women, individuals who are more active:

- have lower rates of all-cause mortality, coronary heart disease, high blood pressure, stroke, type 2 diabetes, metabolic syndrome, colon and breast cancer, and depression;
- are likely to have less risk of a hip or vertebral fracture;
- exhibit a higher level of cardio respiratory and muscular fitness; and
- are more likely to achieve weight maintenance, have a healthier body mass and composition.



The World Health Organization publishes interesting research and documents that can provide you with facts and statistics: <http://www.who.int>

The Mayo Clinic is an excellent source for many of the questions you may have related to exercise and adulthood: <http://www.mayoclinic.com>

There are many changes and challenges that you can look forward to as you move into your adult life. Such things as education, living conditions, relationships, children, finances, and career will all affect your ability to maintain your level of physical fitness.

Use the *Canadian Physical Activity Guidelines* and *Canadian Sedentary Behaviour Guidelines* to answer the following question:



Q3. What are the physical activity requirements for adults (18–64 years)?

Compare this answer to your answer for Question 1 (Youth guidelines).

In adults aged 18–64, physical activity includes leisure time physical activity (eg, walking, dancing, gardening, hiking, swimming), transportation (eg, walking or cycling), occupational (eg, work), household chores, play, games, sports or planned exercise, in the context of daily, family, and community activities. Keep in mind that levels of intensity (moderate to vigorous) are still important components to consider as an adult.



List activities in which you would like to participate to meet the requirements of the adult category, indicating (✓) if they would be moderate- or vigorous-intensity activities.

Activity	Moderate	Vigorous

CHALLENGES TO YOUR FUTURE PHYSICAL ACTIVITY OPPORTUNITIES

Information and available data from the Public Health Agency of Canada show that many Canadians get less than the recommended amount of physical activity for their age group. It is suggested that, in addition to an obesity epidemic, there is also an epidemic of lack of cardio-respiratory fitness.



Did you know?

The Canadian Health Measures Survey of 2007–2009 showed that the proportion of adults whose aerobic fitness was categorized as “fair” or “in need of improvement” increased with age, from 32% of males and 20% of females aged 15 to 19 years to 59% of males and 92% of females aged 60 to 69 years.

There are several reasons why the activities you participate in to achieve the recommended guidelines may change as you get older. These include, but are not limited to, such things as:

- finishing high school where team sports are readily available;
- your focus on new living arrangements depending on your post high school pursuits (college, university, employment);
- the financial costs of joining clubs, teams, fitness facilities;
- your ability to manage your time; or
- your motivation level.

Getting and staying in shape doesn't need to be expensive. You don't need a gym or special equipment for an aerobic workout. Even such activities as taking a brisk walk every day or making a full workout of using stairs can become part of your fitness routine. Don't get caught up in gym memberships or equipment purchases

you can't afford. Instead, concentrate on your fitness goals and brainstorm ways you can meet them without breaking your budget. Here are a few ideas:

- check out your local recreation department;
- consider where you can buy used equipment (eg, dumbbells, exercise DVDs and apps, fitness balls, jump ropes, resistance tubing, hoola hoops); and
- share costs with a friend.



What challenges do you think you may face to meet the activity guidelines in the future?



List strategies that would help you overcome the challenges you have identified?

Practice setting a SMART goal by completing the following activity.



Q4. Set a SMART goal for one of the strategies you have listed above.

SELECTING YOUR PHYSICAL ACTIVITIES



Did you know?

High caloric intake and low physical activity are recognized as key contributors of obesity, diabetes and other chronic health conditions.

In selecting your method of physical activity, being aware that different activities result in different expenditures of energy will help you make better choices when you are managing your time.

For example: A 69 kg man (who is 177 cm tall) will use up about the number of calories listed doing each activity below. Generally, those who weigh more will use more calories, and those who weigh less will use fewer. The calorie values listed include both calories used by the activity and the calories used for normal body functioning.

Approximate calories used by a 69 Kg man	
Moderate physical activities:	In 1 hour
Hiking	370
Light gardening/yard work	330
Dancing	330
Golf (walking and carrying clubs)	330
Bicycling (less than 16 kms per hour)	290
Walking (5.6 kms per hour)	280
Weight training (general light workout)	220
Stretching	180
Vigorous physical activities:	In 1 hour
Running/jogging (8 kms per hour)	590
Bicycling (more than 16 kms per hour)	590
Swimming (slow freestyle laps)	510
Aerobics	480
Walking (7.2 kms per hour)	460
Heavy yard work (chopping wood)	440
Weight lifting (vigorous effort)	440
Basketball (vigorous)	440

Figure A-1 Calories Used by a 69 Kg Man During Physical Activity



Q5. Based on the example above, if the time frame available for an activity was 60 minutes, and if this person's goal was to exercise at a vigorous intensity by bicycling, how fast would he have to bicycle? Circle the correct answer.

- a. Less than 16 kms per hour
- b. More than 16 kms per hour
- c. 8 kms per hour
- d. 7.2 kms per hour



Use the chart below to determine approximately how much energy (calories) you use up with your favourite activity.

Type of Exercise	Calories/hour
Housework	160
Golf	240
Gardening	250
Walking, 4.8kph	280
Tennis	350
Swimming	400
Rollerblading/Skating	420
Aerobic Dance	420
Aerobics	450
Bicycling	450
Jogging, 8kph	500
Swimming	500
Cross Country skiing	500
Hiking	500
Step Aerobics	550
Rowing	550
Power Walking	600
Stationary Bike	650
Jumping Rope	700
Running	700

Figure A-2 Energy expenditure of different exercises



There are energy values for over 500 different activities available at your fingertips simply by doing a google.com search or by visiting <http://www.health-and-fitness-source.com/burning-calories.html>

SELECTING YOUR EXERCISE EQUIPMENT

While moderate- to vigorous-intensity physical activity can be readily practiced without the use of extra equipment (eg, walking, running, etc), there are alternate activities involving equipment for indoor use in the form of full-size machines. To intensify the workout, most of these machines come with electronic controls and built-in exercise programs that vary speed and intensity during a workout.

Treadmill	<ul style="list-style-type: none"> • Most natural form of exercise as it allows you to walk or run at your own pace. • Provides low to intense workouts. • More versatile for home gyms as some can be folded for storage.
Elliptical trainer	<ul style="list-style-type: none"> • Provides exercise workouts similar to combining biking, stair-climbing and cross-country skiing workouts. • Provides moderate to intense low-impact workouts for your legs and to a lesser degree, your arms. • If the machine has reverse motion, you then exercise your buttock muscles.

Exercise bike	<ul style="list-style-type: none"> • Popular form of exercise as they are simple to operate. • Comes with preprogrammed biking routines to provide various workouts. • Some bikes can be plugged into televisions and video games to let you interactively pedal through the visual courses.
Rowing machine	<ul style="list-style-type: none"> • Machine allows you to burn calories in a low-impact workout. • Areas exercised include arms, legs, and torso. • Can have a built-in PC interface to support software accessories.

 For calorie-burning workouts, the treadmill and elliptical trainer are your best choices.

SELECTING PERSONAL DEVICES

Personal devices can be small, such as pedometers, accelerometers and multi-sensor activity tracking devices.

Basic Pedometer	<ul style="list-style-type: none"> • Used to count steps while an individual walks or runs. • Works by pendulum movement as the balanced weight activates to vertical motion which records steps and shows a digital record. • Most are clipped to the belt for use during low-impact exercise (eg, walking).
Pedometer Watches	<ul style="list-style-type: none"> • Come in three different varieties (separate sensor, GPS, watch sensor)
Accelerometer	<ul style="list-style-type: none"> • Use a precision motion sensor to measure calories burned during activity. • Provides a quantitative measurement which counts steps and the force of a person's stride.

 Advanced pedometers and accelerometers have been incorporated into modern cellular telephones and everyday devices including watches. These require you to stream the data to other sources.

SELECTING YOUR MONITORING METHOD

To support and encourage continuous fitness activity, you may want to continue using a form of tracker, journal or log book. Technology also provides numerous avenues to record and monitor physical activity. Multi-sensor tracking devices such as arm bands and heart rate monitors record different physiological measurements and provide a record of physical activities.

Whether you use paper and pencil, physical activity devices, or online monitoring tools that promote physical fitness, each has benefits to assist the user to achieve and maintain a level of fitness.

The exercise heart rate belt is used for an active individual to monitor the heart rate during exercise. The belt has a sensor but is not a stand-alone device. The wireless transmitter sends information to a receiver plugged into the interface box on the machine being used.

The opportunity for personal fitness training continues to grow with the development of more apps for the personal devices and DVDs. With continued development, the consumer options and needs provide more choices.



It is important to collect activity data over multiple days and even weeks to get an accurate record of your exercise program and results.



If you are planning to document and analyze your daily physical activity, first check the device you are using for online support or software compatibility with your PC.

Most equipment can be linked to online or software programs which allow you to monitor your exercise program on a PC. The end result of the exercise program depends on the program you are using. The programs come in various workouts for all fitness levels and goals including:

- cardio,
- strength training,
- circuit training,
- fitness journals, and
- activity calorie calculators.



Fitness music programs can be obtained from online suppliers such as iTunes® or cadencerevolution.com. Other sources can be found online.



Visit www.cadencerevolution.com/index.php/2009/11/weekly-workout-142/ to see a cycling workout with music.

Numerous programs are available online. Whether you want to store the information with the organization or get assistance with your fitness activity, this information is found online. Online services include:

- workout training,
- fitness training,
- weight loss training,
- calories burned training,
- fitness calculator, and
- diet tracker.



The program you want to use may vary from those discussed here. Review fitness apps online and choose the program best suited for your requirements. Some workouts are free and some require you to purchase the program.



More devices and apps are being created to allow people to exercise and record their progress on electronic devices. List devices or apps that you know of that you might be interested in using in the future.

SECTION 2
NUTRITIONAL FITNESS

CALORIES NEEDED FOR OPTIMAL HEALTH

Healthy eating is important for overall health. Your body needs a certain amount of calories (food energy) every day for optimal health and to function without gaining weight. Weight control and healthy eating is a balancing act. A lot depends on your activity level, body metabolism (the way your body converts food to energy), body size and body composition. Along with physical activity, diet is the most well-studied behavioural factor influencing body weight, and overweight and obesity risk.



Activity levels are described by Health Canada as follows:

1. Sedentary: Your typical daily routine requires little physical movement (eg, sitting for long periods, using a computer, relying primarily on motorized transportation) and you accumulate little physical activity in your leisure time.
2. Low Active: Your typical daily routine involves some physical activity (eg, walking to the bus, mowing the lawn, shoveling snow) and you accumulate some additional physical activity in your leisure time.
3. Active: Your typical daily tasks involve some physical activity and you accumulate at least 2 ½ hours of moderate- to vigorous-intensity aerobic physical activity each week. Moderate- to vigorous- physical activity will make you breathe harder and your heart beat faster.

The values in the table below are approximations calculated using Canadian median heights and weights that were derived from the median normal Basic Metabolic Index for different levels of physical activity. Your individual values may be different.

Estimated Energy Requirements						
Males (calories per day)			Age	Females (calories per day)		
Sedentary	Low Active	Active		Sedentary	Low Active	Active
1900	2250	2600	12-13 y	1700	2000	2250
2300	2700	3100	14-16 y	1750	2100	2350
2450	2900	3300	17-18 y	1750	2100	2400
2500	2700	3000	19-30 y	1900	2100	2350
2350	2600	2900	31-50 y	1800	2000	2250
2150	2350	2650	51-70 y	1650	1850	2100
2000	2200	2500	71 y +	1550	1750	2000

Figure A-3 Estimated Energy Requirements



Using the chart above, determine the estimated energy requirement for your current age and for 15 years from now, in each of the activity categories. What is the difference?

Current age		15 years from now
	Sedentary	
	Low active	
	Active	

QUALITY CALORIES

You obtain the calories (energy) that you require for optimal health from the food that you eat. Canada's Food Guide recommends the number of food guide servings per day, based on your age, in each of the following categories:

- vegetables and fruit,
- grain products,
- milk and alternatives, and
- meat and alternatives.



Review *Eating Well with Canada's Food Guide* located at Appendix 2 and complete the following table based on your food intake yesterday.

Category	Number of servings required	My servings yesterday
Vegetables & fruit		
Grain products		
Milk and alternatives		
Meat and alternatives		



How did you do yesterday compared to the Food Guide's recommendation? Do you need to change any of your eating habits to meet the requirements?

MAKING WISE FOOD CHOICES

While the amount of energy (calories) that your body requires for optimal health changes as you age, the quality of the calories you consume to nourish your body remains high. With proper knowledge, you can make wise choices in your food selections. Making healthy food choices can help reduce your risk of nutrition-related chronic diseases such as cancer, diabetes, heart disease and stroke.

Nutrition Facts. This table, found on food products, includes calories and 13 nutrients: fat, saturated fat, trans fat, cholesterol, sodium, carbohydrate, fibre, sugars, protein, Vitamins A and C, calcium and iron. You can use the Nutrition Facts to:

- compare products more easily;
- determine the nutritional value of foods;
- better manage special diets; and
- increase or decrease your intake of a particular nutrient.



All the information in the Nutrition Facts table is based on a specific amount of food. Be sure to compare this amount to the amount you eat.

If the Nutrition Facts table has information based on a piece of meat the size of your hand and you eat a piece of meat twice the size of your hand, then you will need to double the calories and the amount of nutrients listed in order to calculate what your intake would actually be.

% Daily Value. This is included in the Nutrition Facts table and is a benchmark for evaluating the nutrient content of foods quickly and easily. It is based on recommendations for a healthy diet and is also used to determine whether there is a lot or a little of a nutrient in a specific amount of food.



Q6. Use the Nutrition Facts table below to circle the correct answer.

1. What is the serving size of the bread?	1 slice	2 slices	3 slices
2. How many calories are there in one slice of bread?	64	70	140
3. What is the % of sodium in the serving size?	12%	6%	24%
4. How many grams of sugar is in each slice of bread?	1g	2g	4g

Whole Wheat Bread Nutrition Facts Per 2 slices (64 g)			
Amount	% Daily Value		
Calories 140			
Fat 1.5 g	2 %		
Saturated 0.3 g + Trans 0.5 g	4 %		
Cholesterol 0 mg			
Sodium 290 mg	12 %		
Carbohydrate 26 g	9 %		
Fibre 3 g	12 %		
Sugars 2 g			
Protein 5 g			
Vitamin A	0 %	Vitamin C	0 %
Calcium	4 %	Iron	10 %

Figure A-4 Whole Wheat Bread Nutrition Facts



Use the Nutrition Facts tables below to compare a sirloin burger and a chicken burger, then check (✓) the correct answer.

	Higher in the sirloin burger	Higher in the chicken burger	Same in both
1. The specific amount of food is			
2. The % Daily Value of iron is			
3. The sugar content is			
4. The % Daily Value of fat is			
5. The % Daily Value of salt is			

Sirloin Burger Nutrition Facts Per 1 burger (130 g)				Chicken Burger Nutrition Facts Per 1 burger (130 g)			
Amount		% Daily Value		Amount		% Daily Value	
Calories 340				Calories 200			
Fat 27 g		42 %		Fat 9 g		14 %	
Saturated 12 g + Trans 2 g		70 %		Saturated 2 g + Trans 1 g		15 %	
Cholesterol 70 mg				Cholesterol 70 mg			
Sodium 330 mg		14 %		Sodium 800 mg		33 %	
Carbohydrate 3 g		1%		Carbohydrate 4 g		1 %	
Fibre 0 g		0 %		Fibre 0 g		0 %	
Sugars 3 g				Sugars 0 g			
Protein 24 g				Protein 25 g			
Vitamin A	0 %	Vitamin C	0 %	Vitamin A	0 %	Vitamin C	0 %
Calcium	2 %	Iron	30 %	Calcium	4 %	Iron	2 %

Figure A-5 Nutrition Facts Table



The % Daily Value is best used as a comparative benchmark when deciding between two food products.

Nutrition Claims. The Government has rules in place that must be met before a nutrition claim can be made on a label or advertisement. The rules for nutrition claims apply to all foods, prepackaged and not prepackaged, no matter where they are sold. There is no current requirement to include nutrition claims on the label or in advertisements, and many nutrition claims highlight a feature of interest to try to get consumers to purchase the product.

In the chart below, there are several examples of Nutrition Claims and what the claim means related to the amount of food specified in the Nutrition Facts table on the food packaging.

Nutrition Claim	What it means
Source of fibre	The food contains at least 2 grams of dietary fibre.
Low fat	The food contains no more than 3 grams of fat.
Cholesterol-free	The product has a negligible amount (less than 2 mg) of cholesterol and it is also low in saturated fat and trans fat.
Sodium-free	Contains less than 5 mg of sodium.
Reduced in calories	Has at least 25% less energy (calories) than the food it is being compared to.
Light	Only allowed on foods that are either reduced in fat or reduced in energy (calories). Can also be used to describe sensory characteristics of a food, provided that the characteristic is clearly identified with the claim (eg, light tasting, light coloured).



Did you know?

- Most Canadians get more salt than they need. It's best to limit your sodium intake.
- Most sodium comes from sodium chloride better known as table salt or sea salt.
- Salt is a common ingredient in processed and prepared foods, such as canned soups and processed meats.
- Sodium, without chloride, may also be added to foods through additives such as disodium phosphate, sodium nitrate, or sodium gluconate.

Health Canada's recommendation for people aged 14 and over is to not eat more than 2300 mg sodium per day. If you want to know more about sodium intake, visit: <http://www.hc-sc.gc.ca/fn-an/nutrition/sodium/index-eng.php>

The next time you are in the grocery store, challenge yourself to see how many different kinds of canned soup you can find, where the sodium content is less than 15% of the recommended daily value of sodium.



Now that you know what Nutrition Claims are, write down 2 reasons why you think food manufacturers would want to put claims on their food labels.

1. _____
2. _____

List of Ingredients – this is a mandatory list on food product packages. All the ingredients have to be listed in descending order by weight, with the greatest amount in a product listed first.



Q7. In the example given below, which ingredient is present in the greatest amount?

Bran cereal: Ingredients: Whole wheat, wheat bran, sugar / glucose-fructose, salt, malt (corn flour, malted barley), vitamins (thiamine hydrochloride, pyridoxine hydrochloride, folic acid, d-calcium pantothenate), minerals (iron, zinc oxide).



Did you know?

To pick the healthiest breakfast cereals, you need to look at the sugar, fiber, sodium and fat content on the box.

Next time you are at the store, check out the breakfast cereals to see which one has the lowest sugar content.



For more information about Food and Nutrition, check out Health Canada www.hc-sc.gc.ca/fn-an/index-eng.php

THE BALANCING ACT

Eating too much and not getting enough physical activity will result in weight gain. Likewise, eating too little and being very physically active will result in a poorly nourished body and the potential for weight loss. Setting SMART goals related to nutrition is a very positive way to develop and maintain good eating habits throughout your life.

Goal: To start eating more fruit.	This goal would be hard to measure (what do you mean by “more” fruit?) and needs a time frame (when will you start and finish?).
SMART Goal: To eat 1 fruit with lunch 4 times this week.	This goal is specific, measureable and has a specific timeframe. You will be able to determine if you have reached your goal.



Q8. Fill in the box to make the following nutritional goal a SMART nutritional goal.

Goal: To balance my food intake.	SMART Goal: _____ _____
--	--------------------------------------

BUDGET SHOPPING FOR FOOD



Budget Shopping for Food

There are steps that you can take to stay within your budget when you are shopping for groceries.

- Buy only what you need – plan a menu first then make a shopping list.
- Keep a list in your kitchen – jot down items as you need them.
- Pay with cash if you can – spend only the money you have allocated.
- Try not to shop when hungry – it helps keep you from buying food you don't need.
- Buy fewer convenience foods.
- Buy fewer prepared foods – these items usually cost more and are higher in sugar, salt and fat.
- Look for best buys – check store flyers, use coupons, buy store or no-name brands.
- Look at the top and bottom of shelves – higher priced items are usually placed at eye level.
- Compare unit prices – to compare similar foods of different sizes.

COMPARING RECIPES

A great way to fuel your body with higher quality food is to check out the differences in recipe ingredients and select the most nutrient-dense foods. Using the same principles as when you were looking at Nutrition Fact Tables, you would analyze recipes and make informed decisions.



There are many great resources available online to help you plan menus, compare recipes and track your food and activity patterns. Check out provincial and federal government resources.

SECTION 3 MENTAL FITNESS

Mental fitness is an important component of a healthy lifestyle. Just as physical and nutritional fitness helps your body to stay strong, mental fitness helps you achieve and sustain a state of good mental health. Being mentally healthy means striking a healthy balance in all areas of your life:

- social,
- physical,
- spiritual,
- economic, and
- mental.

The benefits of being mentally fit include:

- enjoyment of life, the environment and people in it;
- being creative, learn, try new things and take risks;
- better able to cope with difficult times in your personal and professional life; and
- able to feel strong emotions (sadness, anger) and then get on with and enjoy life once again.

Reaching a balance is a learning process that comes with experience and lots of practice. Sometimes you may tip the balance in one direction more than another and you will need to rebalance yourself. At times you may be able to rebalance on your own while at other times you may need to ask for assistance in getting yourself back on track. Good mental health helps you enjoy life and cope with problems. You have to work to keep your mind healthy.

Stress and how you respond to it will be one of the biggest factors contributing to your mental fitness balancing abilities. It comes from both the good (positive) and bad (negative) things that happen to you and becomes a problem when you are not sure how to handle a situation or are unable to. That's when worry steps in and makes you feel stressed. Stress that is not dealt with properly may result in anxiety, depression or panic attacks.

Along with pressures for you to succeed at school, at home and in social circumstances, there may be many new challenges coming up for you such as:

- leaving home,
- employment,
- education,
- balancing work or school with healthy relationships,
- eating properly, or

- ill family members.



Write down challenges that you think you could face in the future.

Good mental health depends on several things:

- the food you eat – can have a direct effect on your energy level, physical health and mood;
- regular physical activity – your body makes certain chemicals before and after you work out, called endorphins, which relieve stress and improve your mood;
- sleep – your body needs time every day to rest and heal; and
- mental health tools – ways and means that you have to cope with difficult times, stress and challenges.

SELF-ESTEEM



Self-esteem is the value you place on yourself. It is the feeling that you have about all the things you see yourself to be. It is the knowledge that you are loveable, you are capable and you are unique.

Good self-esteem means:

- having a healthy view of yourself;
- having a quiet sense of self worth;
- having a positive outlook;
- feeling satisfied with yourself most of the time; and
- setting realistic goals.

Your self-esteem can be affected by others around you who are feeling down, negative and dissatisfied with school, relationships or life in general. Being aware of conditions or behaviours affecting mental fitness can be of significant help to you or to a friend in need.

	What is it?	Warning Signs	What can you do?
Self-injury	<p>Also known as self-harm and self-abuse it refers to deliberate acts that cause harm to one's body or spirit.</p> <p>Person may be troubled by frequent intense, painful emotions.</p> <p>Missing ways to cope with handling emotions</p>	<p>Unexplained frequent injuries, such as cuts and burns; hair pulling; scratching or picking scabs preventing wounds from healing.</p> <p>Wearing long pants and long sleeved shirts in warm weather.</p>	<p>If it's yourself – begin talking to someone you trust; your doctor may be able to recommend a therapist or psychologist who can help; look for a support group in your area.</p> <p>If it's someone else – listen; offer support without judging</p>

	What is it?	Warning Signs	What can you do?
	effectively. This bottleneck of emotions is released by cutting, burning or otherwise hurting themselves. Short term solution with serious consequences.	Low self esteem. Problems handling emotions. Problems with relationships.	or criticizing; try not to blame or react as though their behaviour is impossible to understand. In both instances, treatment by a mental health professional is recommended.
Psychosis	A treatable medical condition that affects the brain and can result in some loss of contact with reality. Ongoing changes in behaviour, personality and day to day functioning. Affects 3% of the population at some point in their lives.	Early on - withdrawn; sullen; won't get out of bed, get dressed or showered; lashes out for no apparent reason; walks around showing no emotion. Person may appear anxious, suspicious, disorientated. If not treated, more serious symptoms develop.	If it's yourself - be aware of the early symptoms; don't ignore the warning signs or take a wait and see attitude; talk to someone you trust. If it's someone else – be aware of the symptoms; be supportive; encourage the person to seek professional help.
Suicide	The intentional taking of one's own life.	Sudden change in behaviour (positive or negative). Apathy, withdrawal, change in eating patterns Unusual preoccupation with death and dying. Giving away valued personal possessions Signs of depression, moodiness, hopelessness. One or more previous suicide attempts. Suicidal thoughts.	If it's you – talk to someone you trust and who can help (parent, teacher, residence supervisor). Call a crisis centre hotline. If it's someone else – talking calmly about suicide, without showing fear or making judgments, can bring relief to someone who is feeling terribly isolated. Don't promise not to tell. Tell someone in a position to help (teacher, parent, a residence supervisor). Encourage the person to call a crisis centre hotline.
Depression	It's common to experience depressed moods or "the blues" at some point in life. Depression is when feelings persist and result in significant distress or dysfunction in daily activities.	Depressed mood. Marked loss of interest or pleasure in things that used to give pleasure. Significant weight loss or gain, or pain. Difficulty falling asleep or staying asleep or sleeping too much.	If it's yourself – talk to someone you trust and who can help; seek professional help; take good care of yourself through positive lifestyle choices; find time to socialize; manage your stress. If it's someone else – be supportive; suggest they

	What is it?	Warning Signs	What can you do?
		Feelings of apathy or agitation. Loss of energy. Feelings of worthlessness or guilt. Inability to concentrate or make decisions.	seek professional help; listen; support.
Alcohol Poisoning	A serious, potential consequence of binge drinking. Binge drinking is considered to be five drinks or more in a row for a man and four drinks or more for a woman – having a six pack or a bottle of wine in one session.	Confusion Vomiting Problems breathing Clammy skin and low body temperature Loss of bladder control Unconsciousness	If it's you – get help. Drinking isn't necessary to fit in with your peers; select positive ways to reduce stress and anxiety. If it's someone else –get help. If there isn't a trusted adult nearby, call 911 or emergency services immediately.



The Canadian Public Health Association has a good site with more information, including an interesting scenario: <http://www.cpha.ca/en/portals/substance/article02.aspx>

HOW TO PRACTICE MENTAL FITNESS

There are many ways for you to practice mental fitness. You can develop your own tools and practices to ensure that your responses to stress, challenges and difficult situations result in a strong, positive outcome.



Beside each of the following suggestions for practicing mental fitness, check off any of the items you think you could do or incorporate into your lifestyle in the future.

	Which activity can you do to practice mental fitness?	√
1	Wake up each day and be grateful for another lovely day.	
2	TTSP – This Too Shall Pass – with experience, you will come to know that rough times will pass. When something sad or negative happens, remind yourself that you will feel better soon and that will help you get through those difficult first days.	
3	Participate in some form of exercise early in the day, to get you going for the rest of the day.	
4	Sit back, take a few deep breaths and watch the clouds go by.	
5	Join a local league or college group of some sort (hockey, badminton, walking, book club, etc) to keep yourself active and socially connected.	
6	Curl up with a good book.	
7	Take a dog for a walk and watch how they love to run and play.	
8	Listen to your favorite music and sing your heart out.	
9	Spend some time enjoying the great outdoors – enjoy the sunshine; splash in some puddles; hike your favorite trail.	
10	Use motivational quotes – post your favorite motivational quote where you can see it daily.	
11	Take a short break from what you are doing (studying, cleaning, etc), to do the things you enjoy doing. You'll come back refreshed and ready to carry on.	
12	Meditation practice – helps develop perspective, have realistic expectations of others and develop strategies to reduce stress.	
13	Get together with friends for coffee dates, potlucks or gab sessions.	
14	Do something creative like knitting, painting, drawing, carving, or music lessons.	
15	Bring humor into your life by engaging in funny activities, laughing uncontrollably, telling a funny joke, watching your favorite comedy show, playing a funny joke on a friend.	
16	Practice Pilates or yoga with a group or on your own.	
17	Cook or bake - this can be soothing, creative and productive, plus you get something yummy to eat!	
18	Do something just for you – this can bring much needed balance in your life.	
19	Go for a massage.	
20	Take a power nap.	

How many √ marks do you have? _____

You may be surprised to see that there are many activities that you have identified that you can use to promote your mental fitness.



Q9. True or False? Self-esteem means:

1	Having a healthy view of yourself	
2	Having a quiet sense of self worth	
3	Having a negative outlook	
4	Feeling dissatisfied with yourself most of the time	
5	Setting realistic goals	



For more information on mental health tips, go to the Canadian Mental Health Association
http://www.cmha.ca/mental_health/mental-fitness-tips/

MOTIVATIONAL QUOTES

One of the mental fitness activities above (#10) involves the use of motivational quotes. Your outlook can be inspired and charged by having your favorite quote(s) available at your fingertips as positive reminders of goals you have set for yourself.



Read the following motivational quotes and highlight the ones that you like.

<p>“Act as if what you do makes a difference. It does.” William James</p>	<p>“I can therefore I am.” Simone Weil</p>
<p>Life can only be understood backwards; but it must be lived forwards.” Soren Kierkegaard</p>	<p>“Experience is not what happens to you; it’s what you do with what happens to you.” Aldous Huxley</p>
<p>“Optimism is the faith that leads to achievement. Nothing can be done without hope and confidence.” Helen Keller</p>	<p>“If you want to conquer your fear, don’t sit home and think about it. Go out and get busy.” Dale Carnegie</p>
<p>“Problems are not stop signs, they are guidelines.” Robert h. Schuller</p>	<p>“I’d rather do something great and fail than attempt to do nothing and succeed.” Robert H. Schuller</p>
<p>“The person who has lived the most is not the one with the most years but the one with the richest experiences.” Jean-Jacques Rousseau</p>	<p>“What you get by achieving your goals is not as important as what you become by achieving your goals.” Henry David Thoreau</p>

<p>“I think everything is possible if you put your mind to it and you put the work and time into it. I think your mind really controls everything.” Michael Phelps</p>	<p>“I don’t measure a man’s success by how high he climbs but by how high he bounces when he hits the bottom.” George S. Patton</p>
<p>“Life is a journey not a destination.” Ralph Waldo Emerson</p>	<p>“If you can dream it, you can do it.” Walt Disney</p>
<p>“Even if you fall on your face, you’re still moving forward.” Victor Kiam</p>	<p>“Don’t cry because it’s over, smile because it happened.” Dr. Seuss</p>
<p>“You are never too old to set a new goal, or to dream a new dream.” C.S. Lewis</p>	<p>“In order to succeed, we must first believe that we can.” Nikos Kazantzakis</p>



Write your favourite motivational quote on a large piece of paper and post it at your corps/squadron. Select from the ones above or use another one that really motivates you.



Promise Yourself

To be so strong that nothing
can disturb your peace of mind.

To talk health, happiness, and prosperity
to every person you meet.

To make all your friends feel
that there is something in them

To look at the sunny side of everything
and make your optimism come true.

To think only the best, to work only for the best,
and to expect only the best.

To be just as enthusiastic about the success of others
as you are about your own.

To forget the mistakes of the past
and press on to the greater achievements of the future.

To wear a cheerful countenance at all times
and give every living creature you meet a smile.

To give so much time to the improvement of yourself
that you have no time to criticize others.

To be too large for worry, too noble for anger, too strong for fear,
and too happy to permit the presence of trouble.

To think well of yourself and to proclaim this fact to the world,
not in loud words but great deeds.

To live in faith that the whole world is on your side
so long as you are true to the best that is in you.”

Figure A-6 The Promise, by Christian Larson

CONCLUSION

As you move to future education / work from organized activities provided by cadet training, the planning and scheduling of leisure time for physical fitness, nutritional and mental fitness activities becomes your responsibility. The information, challenges and strategies reviewed in this self-study package have provided you the resources to continue to sustain a healthy lifestyle.

Whether you use exercise equipment, small devices, online programs, individual or group support, it is your responsibility to participate in and adopt a healthy lifestyle. A plethora of resources may be used to address physical, nutritional and mental fitness.

As you progress into future training and education, the benefits of physical, nutritional and mental fitness will help you maintain a healthy lifestyle.



Congratulations, you have completed your self-study package on EO C504.01 (Reflect on Personal Fitness and Healthy Living). Hand your completed package to the Training Officer / Course Officer who will record its completion in your Proficiency Level Five logbook.

Canadian Physical Activity Guidelines

FOR YOUTH - 12 – 17 YEARS

Guidelines



For health benefits, youth aged 12-17 years should accumulate at least 60 minutes of moderate- to vigorous-intensity physical activity daily. This should include:



Vigorous-intensity activities at least 3 days per week.



Activities that strengthen muscle and bone at least 3 days per week.



More daily physical activity provides greater health benefits.

Let's Talk Intensity!

Moderate-intensity physical activities will cause teens to sweat a little and to breathe harder. Activities like:

- Skating
- Bike riding

Vigorous-intensity physical activities will cause teens to sweat and be 'out of breath'. Activities like:

- Running
- Rollerblading

Being active for at least 60 minutes daily can help teens:

- Improve their health
- Do better in school
- Improve their fitness
- Grow stronger
- Have fun playing with friends
- Feel happier
- Maintain a healthy body weight
- Improve their self-confidence
- Learn new skills

Parents and caregivers can help to plan their teen's daily activity. Teens can:

- Walk, bike, rollerblade or skateboard to school.
- Go to a gym on the weekend.
- Do a fitness class after school.
- Get the neighbours together for a game of pick-up basketball, or hockey after dinner.
- Play a sport such as basketball, hockey, soccer, martial arts, swimming, tennis, golf, skiing, snowboarding...

**Now is the time. 60 minutes
a day can make a difference.**



Canadian Sedentary Behaviour Guidelines

FOR YOUTH - 12 – 17 YEARS

Guidelines

For health benefits, youth aged 12–17 years should minimize the time they spend being sedentary each day. This may be achieved by



Limiting recreational screen time to no more than 2 hours per day; lower levels are associated with additional health benefits.



Limiting sedentary (motorized) transport, extended sitting and time spent indoors throughout the day.

The lowdown on the slowdown: what counts as being sedentary?

Sedentary behaviour is time when teens are doing very little physical movement. Some examples are:

- Sitting for long periods
- Using motorized transportation (such as a bus or a car)
- Watching television
- Playing passive video games
- Playing on the computer

Spending less time being sedentary can help teens:

- Maintain a healthy body weight
- Improve their self-confidence
- Do better in school
- Improve their fitness
- Have more fun with their friends
- Have more time to learn new skills

Cutting down on sitting down. Help teens swap sedentary time with active time!



Now is the time for teens to get up and get moving!



Canadian Physical Activity Guidelines

FOR ADULTS - 18 – 64 YEARS

Guidelines



To achieve health benefits, adults aged 18-64 years should accumulate at least 150 minutes of moderate- to vigorous-intensity aerobic physical activity per week, in bouts of 10 minutes or more.



It is also beneficial to add muscle and bone strengthening activities using major muscle groups, at least 2 days per week.



More physical activity provides greater health benefits.

Let's Talk Intensity!

Moderate-intensity physical activities will cause adults to sweat a little and to breathe harder. Activities like:

- Brisk walking
- Bike riding

Vigorous-intensity physical activities will cause adults to sweat and be 'out of breath'. Activities like:

- Jogging
- Cross-country skiing

Being active for at least 150 minutes per week can help reduce the risk of:

- Premature death
- Heart disease
- Stroke
- High blood pressure
- Certain types of cancer
- Type 2 diabetes
- Osteoporosis
- Overweight and obesity

And can lead to improved:

- Fitness
- Strength
- Mental health (morale and self-esteem)

Pick a time. Pick a place. Make a plan and move more!

- Join a weekday community running or walking group.
- Go for a brisk walk around the block after dinner.
- Take a dance class after work.
- Bike or walk to work every day.
- Rake the lawn, and then offer to do the same for a neighbour.
- Train for and participate in a run or walk for charity!
- Take up a favourite sport again or try a new sport.
- Be active with the family on the weekend!

**Now is the time. Walk, run,
or wheel, and embrace life.**



THIS PAGE INTENTIONALLY LEFT BLANK



Health Canada Santé Canada

Your health and safety... our priority.

Votre santé et votre sécurité... notre priorité.

Eating Well with Canada's Food Guide

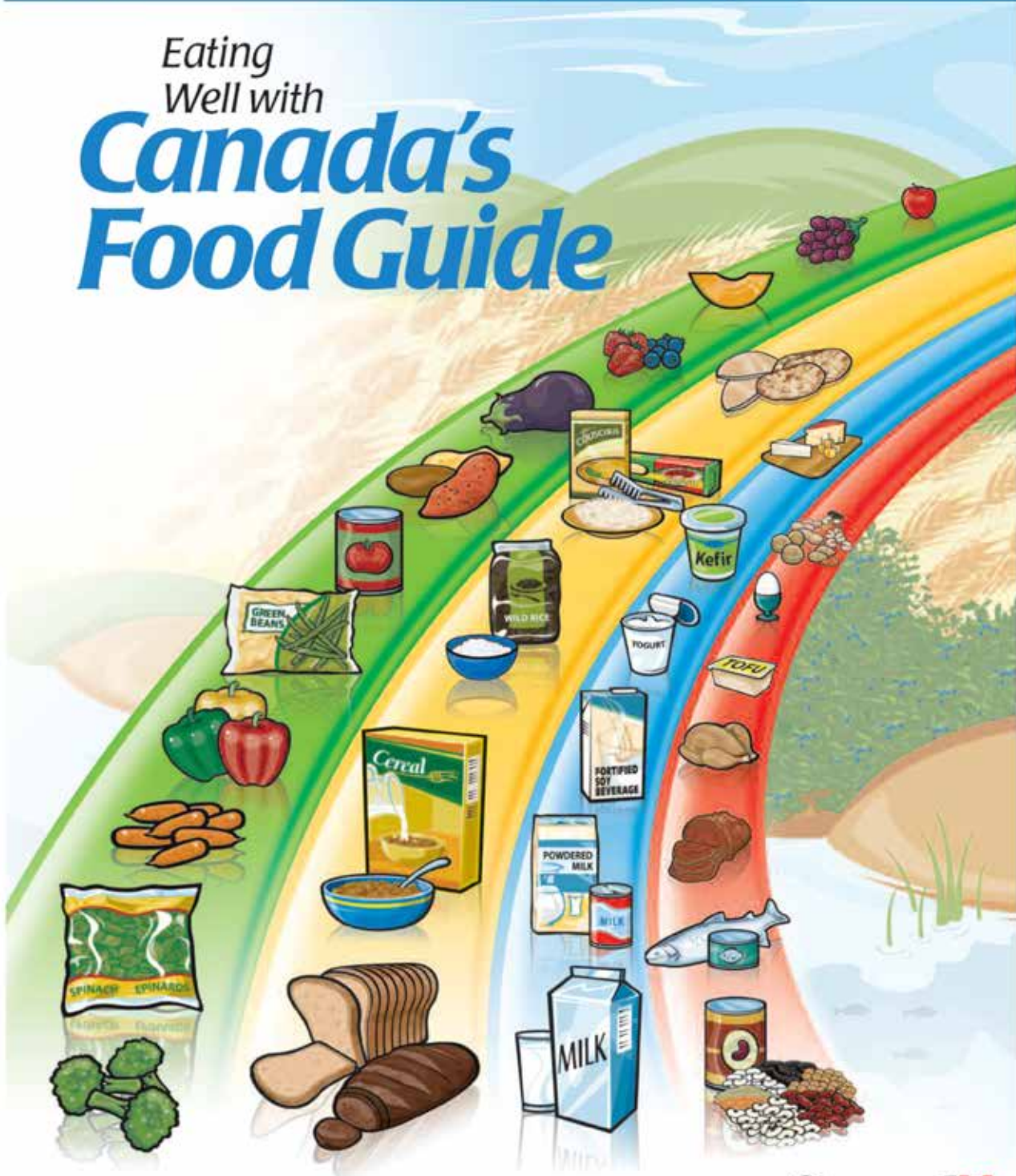

Canada

Recommended Number of Food Guide Servings per Day





Age in Years Sex	Children			Teens		Adults			
	2-3	4-8	9-13	14-18		19-50		51+	
	Girls and Boys			Females	Males	Females	Males	Females	Males
Vegetables and Fruit	4	5	6	7	8	7-8	8-10	7	7
Grain Products	3	4	6	6	7	6-7	8	6	7
Milk and Alternatives	2	2	3-4	3-4	3-4	2	2	3	3
Meat and Alternatives	1	1	1-2	2	3	2	3	2	3

The chart above shows how many Food Guide Servings you need from each of the four food groups every day.

Having the amount and type of food recommended and following the tips in *Canada's Food Guide* will help:

- Meet your needs for vitamins, minerals and other nutrients.
- Reduce your risk of obesity, type 2 diabetes, heart disease, certain types of cancer and osteoporosis.
- Contribute to your overall health and vitality.

What is One Food Guide Serving?
 Look at the examples below.

 <p>Fresh, frozen or canned vegetables 125 mL (½ cup)</p>		 <p>Leafy vegetables Cooked: 125 mL (½ cup) Raw: 250 mL (1 cup)</p>		 <p>Fresh, frozen or canned fruits 1 fruit or 125 mL (½ cup)</p>		 <p>100% Juice 125 mL (½ cup)</p>					
 <p>Bread 1 slice (35 g)</p>		 <p>Bagel ½ bagel (45 g)</p>		 <p>Flat breads ½ pita or ½ tortilla (35 g)</p>		 <p>Cooked rice, bulgur or quinoa 125 mL (½ cup)</p>		 <p>Cereal Cold: 30 g Hot: 175 mL (¾ cup)</p>		 <p>Cooked pasta or couscous 125 mL (½ cup)</p>	
 <p>Milk or powdered milk (reconstituted) 250 mL (1 cup)</p>		 <p>Canned milk (evaporated) 125 mL (½ cup)</p>		 <p>Fortified soy beverage 250 mL (1 cup)</p>		 <p>Yogurt 175 g (¾ cup)</p>		 <p>Kefir 175 g (¾ cup)</p>		 <p>Cheese 50 g (1 ½ oz.)</p>	
 <p>Cooked fish, shellfish, poultry, lean meat 75 g (2 ½ oz.)/125 mL (½ cup)</p>		 <p>Cooked legumes 175 mL (¾ cup)</p>		 <p>Tofu 150 g or 175 mL (¾ cup)</p>		 <p>Eggs 2 eggs</p>		 <p>Peanut or nut butters 30 mL (2 Tbsp)</p>		 <p>Shelled nuts and seeds 60 mL (¼ cup)</p>	



Oils and Fats

- Include a small amount – 30 to 45 mL (2 to 3 Tbsp) – of unsaturated fat each day. This includes oil used for cooking, salad dressings, margarine and mayonnaise.
- Use vegetable oils such as canola, olive and soybean.
- Choose soft margarines that are low in saturated and trans fats.
- Limit butter, hard margarine, lard and shortening.



THIS PAGE INTENTIONALLY LEFT BLANK

SOLUTIONS



Q1. What are the physical activity guidelines for youth ages 12–17 years?

A1. At least 60 minutes of moderate to vigorous activity daily. This should include: vigorous intensity activities at least 3 days per week and activities that strengthen muscle and bone at least 3 days per week.



Q2. What are the sedentary behaviour guidelines for youth ages 12–17 years?

A2. Minimize the time they spend being sedentary each day. This may be achieved by limiting recreational screen time to no more than 2 hours per day; limit sedentary (motorized) transport, extended sitting time and time spent indoors throughout the day.



Q3. What are the physical activity requirements for adults (18–64 years)?

Compare this answer to your answer for Question 1 (Youth Guidelines).

A3. Accumulate at least 150 minutes of moderate-to-vigorous-intensity aerobic physical activity per week, in bouts of 10 minutes or more. Add muscle and bone strengthening activities using major muscle groups, at least 2 days per week. The moderate-to-vigorous activity requirements are less for adults, the sessions shorter, strengthening activities go from 3 days to 2 days.



Q4. Set a SMART goal for one of the strategies you have listed above.

A4. Answers will vary. Goal should include SMART principles.



Q5. Based on the example above, if the time frame available for an activity was 60 minutes, and if this person's goal was to exercise at a vigorous intensity by bicycling, how fast would he have to bicycle? Circle the correct answer.

- a. Less than 16 kms per hour
- b. **More than 16 kms per hour**
- c. 8 kms per hour
- d. 7.2 kms per hour



Q6. Use the Nutrition Facts table below to circle the correct answer.

1. What is the serving size of the bread?	1 slice	2 slices	3 slices
2. How many calories are there in one slice of bread?	64	70	140
3. What is the % of sodium in the serving size?	12%	6%	24%
4. How many grams of sugar is in each slice of bread?	1g	2g	4g



Q7. In the example given below, which ingredient is present in the greatest amount?

A7. Whole wheat.



Q8. Fill in the box to make the following nutritional goal a SMART nutritional goal.

Goal:

To balance my food intake.

SMART Goal:

Answers will vary but should meet SMART goal principles.



Q9. True or False? Self-esteem means:

1	Having a healthy view of yourself	True
2	Having a quiet sense of self worth	True
3	Having a negative outlook	False
4	Feeling dissatisfied with yourself most of the time	False
5	Setting realistic goals	True



**COMMON TRAINING
PROFICIENCY LEVEL FIVE
INSTRUCTIONAL GUIDE**



SECTION 1

EO M507.01 – DEVELOP A PERSONALIZED SCHEDULE

Total Time:

90 min

PREPARATION

PRE-LESSON INSTRUCTIONS

Resources needed for the delivery of this lesson are listed in the lesson specification located in A-CR-CCP-805/PG-001, *Proficiency Level Five Qualification Standard and Plan*, Chapter 4. Specific uses for said resources are identified throughout the instructional guide within the TP for which they are required.

Review the lesson content and become familiar with the material prior to delivering the lesson.

Review year four CSTC training opportunities found at CATO 51-01 *Air Cadet Program Outline*, as the prerequisites for training may change.

Review CSTC advanced training - staff cadet opportunities found at CATO 13-28, *Advanced Training–Staff Cadets*, as the prerequisites for positions may change.

Photocopy Attachment A for each cadet.

PRE-LESSON ASSIGNMENT

Nil

APPROACH

An interactive lecture was chosen for TPs 1, 2 and 5 to orient the cadets to and generate interest in Proficiency Level Five mandatory and complementary training opportunities as well as the On-the-Job Practical Requirements (OJPR) and OJPR Logbook.

A group discussion was chosen for TPs 3 and 4 as it allows the cadets to interact with their peers and share their knowledge, experiences, opinions, and feelings about summer training opportunities, leadership assignments and leadership appointments at the squadron.

An in-class activity was chosen for TP 6 as it is an interactive way to provoke thought and stimulate interest among the cadets as they develop a personalized schedule.

INTRODUCTION

REVIEW

Nil.

OBJECTIVES

By the end of this lesson the cadet shall have identified the training opportunities in Proficiency Level Five and have developed a personalized schedule for the training year(s).

IMPORTANCE

It is important for cadets to know what training will be conducted during Proficiency Level Five to give them an overview of what the training year(s) will entail. This lesson will help generate interest in the topics and provide a basis on which the cadet will balance school, work, personal and cadet commitments to establish a personalized schedule.

Teaching Point 1**Identify Proficiency Level Five mandatory training common to the sea, army and air elements of the CCO.**

Time: 10 min

Method: Interactive Lecture

OVERVIEW

The training program is broken into performance objectives (POs), which are the overall subjects, and enabling objectives (EOs), which are the topics within each PO. Training is conducted as mandatory and complementary components. Proficiency Level Five also sees the addition of two new topic areas, Professional Development and Personal Development.

MANDATORY TRAINING

Mandatory training encompasses the EOs that all cadets must complete throughout the training year(s). Proficiency Level Five mandatory training is common for sea, army and air cadets. The number of periods allocated for mandatory training is minimal, to allow cadets more free time to tailor their training year(s) to suit their individual circumstances.

Community Service – PO 502 (Perform Community Service)

The aim of Proficiency Level Five community service is to encourage the cadet to be an active citizen through participation in local community service activities. Cadet are expected to complete a prescribed number of hours of community service, with at least one of those activities completed with the community service learning model, to meet the requirements of this PO.

Leadership – PO 503 (Lead Cadet Activities)

The aim of Proficiency Level Five leadership is to provide the cadet with knowledge and skills to practice leadership during naturally occurring leadership assignments, structured leadership appointments, and a team leadership project. The cadet, as a member of a team, will:

- propose an exercise;
- plan an exercise;
- conduct an exercise; and
- conclude an exercise.

Personal Fitness and Healthy Living – PO 504 (Adopt an Active Lifestyle)

The aim of Proficiency Level Five personal fitness and healthy living is to encourage the cadet to set and pursue fitness goals that contribute to an active lifestyle. Cadets are expected to complete the Cadet Fitness Assessment as well as a prescribed number of hours of physical fitness to satisfy the requirements of this PO.

General Cadet Knowledge – PO 507 (Serve in an Air Cadet Squadron)

The aim of Proficiency Level Five general cadet knowledge is to provide the cadet with information on the opportunities inherent in the Air Cadet Program and prepare the cadet for Proficiency Level Five assessment of learning requirements. Cadets will identify the training opportunities available in Proficiency Level Five.

Instructional Techniques – PO 509 (Instruct Cadets)

The aim of Proficiency Level Five instructional techniques is to refine the cadet's skills in instructing a 30-minute lesson. Cadets are required to be successful on at least one assessment of their instructional skills during Proficiency Level Five. Since Proficiency Level Five cadets will normally be the primary instructors at the local

squadron, many opportunities exist for them to develop their skills. Lessons can also be delivered at other locations, such as at Cadet Summer Training Centres (CSTCs), gliding centres, etc.

Professional Development – PO 513 (Attend a Workshop)

The aim of PO 513 (Attend a Workshop) is to provide the cadet with professional development to enhance common training skills. Workshops are intended to be tri-service and provide the opportunity for cadets to participate in consolidated training with peers from different corps and squadrons on a variety of topics related primarily to leadership and instructional techniques. Proficiency Level Five cadets are expected to complete two days of workshops to successfully complete this PO.

Personal Development – PO 514 (Pursue Individual Learning)

The aim of PO 514 (Pursue Individual Learning) is to provide the cadet an opportunity to pursue an Air Cadet Program topic area using a personal learning plan to develop specialist skills. The participation and / or performance requirements are defined through an individual learning plan (ILP) that outlines a series of objectives to be met within the cadet's area of interest. The ILP is developed by the cadet in consultation with the Proficiency Level Officer and Squadron Training Officer and approved by the Commanding Officer (CO). The provision of a goal setting opportunity allows the cadet to pursue an area of personal interest related to the CP.

CONFIRMATION OF TEACHING POINT 1

QUESTIONS:

- Q1. What is the aim of Proficiency Level Five citizenship training?
- Q2. What is a cadet expected to complete to satisfy the requirements of PO 504?
- Q3. Will workshops be elemental or tri-service?

ANTICIPATED ANSWERS:

- A1. The aim of Proficiency Level Five citizenship is to introduce the cadet to their roles and responsibilities as a citizen in a globalized world.
- A2. Cadets are expected to complete the Cadet Fitness Assessment as well as a prescribed number of hours of physical fitness to satisfy the requirements of PO 504.
- A3. Workshops are intended to be tri-service and provide the opportunity for cadets to participate in consolidated training with peers from different corps / squadrons on a variety of topics related primarily to leadership and instructional techniques.

Teaching Point 2**Identify Proficiency Level Five complementary training opportunities.**

Time: 10 min

Method: Interactive Lecture

PROFICIENCY LEVEL FIVE COMPLEMENTARY TRAINING

Proficiency Level Five complementary training has been designed to be self-directed, self study and three periods (90 minutes) in length. The cadet will complete a minimum of three complementary packages. While the packages are self study, they are not intended to be treated as take home assignments. Instead, cadets shall be given time during a regular training session or day to complete the packages (eg, on a parade night when the cadet is not scheduled to instruct or lead an activity). There is nothing precluding a cadet from completing additional self-study packages at any time, should they choose to do so.

COMMON COMPLEMENTARY TRAINING

Common complementary training self study packages are available in four topic areas.

Citizenship – PO 501 (Explain Global Citizenship)

C501.01 (Reflect Upon What It Means To Be a Good Canadian Citizen) examines what it means to be Canadian and how to become an active and responsible citizen;

C501.02 (Reflect Upon Individual Global Citizenship) provides the cadet an opportunity to reflect upon how globalization affects daily choices in all aspects of life; and

C501.03 (Analyze a Global Issue) provides the cadet with an opportunity to develop their critical thinking / reading skills.

Personal Fitness and Healthy Living – PO 504 (Adopt an Active Lifestyle)

C504.01 (Reflect on Personal Fitness and Healthy Living) allows the cadets to reflect on and examine in greater detail the key concepts related to physical fitness and healthy living.

General Cadet Knowledge – PO 507 (Serve in an Air Cadet Squadron)

C507.01 (Identify Service Opportunities as a Cadet Instructors Cadre [CIC] Officer) examines the choices available to a senior cadet who, upon leaving the CP, chooses to enroll as a member of the CIC. Service opportunities range from local corps / squadron participation to supervising national activities.

C507.02 (Identify Volunteer Opportunities with the Air Cadet League League of Canada [ACLC]) examines the options available to a senior cadet who, upon leaving the CP, chooses to support it by volunteering with the ACLC. This option may suit youth who cannot or do not wish to enrol in the CIC. This self study package includes the opportunity to meet with a member of the squadron's sponsoring committee.

C507.03 (Reflect on the Cadet Experience) provides the tools for a cadet to discover the skills and experience the CP has provided them. It also examines the need to set goals, both short and long term and how to achieve them using an action plan.

Instructional Techniques – PO 509 (Instruct Cadets)

C509.01 (Monitor Instruction) provides cadets with the knowledge and tools to evaluate instruction. This is accomplished through self study and the practical observation of a class.

ELEMENTAL COMPLEMENTARY TRAINING

Elemental training self-study packages are available in four topic areas.

Airmanship – PO 530 (Fly a Cross-Country Flight Using a Flight Simulator)

C530.01 (Fly a Cross-Country Flight Using a Flight Simulator) provides cadets with an opportunity to fly a cross-country flight using a flight simulator. Within this activity, cadets will plot a visual flight rules (VFR) flight on a VNC and determine aircraft speed.

Aerospace – PO 540 (Reflect on Canada's Contribution to Aerospace Technology)

C540.01 (Reflect on Canada's Contribution to Aerospace Technology) provides cadets with an opportunity to learn about Canada's aerospace technology accomplishments up to the cancellation of the Avro Canada CF-105 Arrow Project and examine the achievements of Avro Canada Limited personnel. Additionally, cadets will reflect on Canada's contribution to the space program and aircraft development.

Aerodrome Operations – PO 560 (Participate in an Aerodrome Operations Activity)

C560.01 (Examine Aspects of Flight Safety [FS]) provides cadets with an opportunity to learn about the role of the Flight Safety Officer (FSO) in the Air Cadet Flying Program (ACFP) and to examine the reporting process and investigation procedures.

C560.02 (Examine the Canadian Bush Pilot Industry) provides cadets with an opportunity to examine the origin and development of bush flying in Canada and to compare aircraft flown.

Aircraft Manufacturing and Maintenance – PO 570 (Examine Aspects of Aircraft Manufacturing and Maintenance Through the Development of Aerobatic Aircraft)

C570.01 (Examine Aspects of Aircraft Manufacturing and Maintenance Through the Development of Aerobatic Aircraft) provides cadets with an opportunity to examine the origin of acrobatic flight, aircraft development, modern aerobatic displays and Canadian aerobatic teams.

Aircrew Survival – PO 590 (Analyze an Aircrew Survival Case Study)

C590.01 (Analyze an Aircrew Survival Case Study) provides cadets with an opportunity to, using a case study of a real incident, analyze the cause of the accident, examine the survival situation, investigate the actions of the crew and analyze the outcome.

CONFIRMATION OF TEACHING POINT 2

QUESTIONS:

- Q1. How is Proficiency Level Five complementary training designed?
- Q2. Describe C507.01 (Identify Service Opportunities as a Cadet Instructors Cadre [CIC] Officer).
- Q3. Describe C560.02 (Examine the Canadian Bush Pilot Industry).

ANTICIPATED ANSWERS:

- A1. Proficiency Level Five complementary training has been designed to be self-directed, self study and three periods (90 minutes) in length.
- A2. C507.01 (Identify Service Opportunities as a Cadet Instructors Cadre [CIC] Officer) examines the choices available to a senior cadet who, upon leaving the CP, chooses to enrol as a member of the CIC. Service opportunities range from local corps / squadron participation to supervising national activities.

- A3. C560.02 (Examine the Canadian Bush Pilot Industry) provides cadets with an opportunity to examine the origin and development of bush flying in Canada and to compare aircraft flown.

Teaching Point 3

Review summer training opportunities.

Time: 5 min

Method: Group Discussion

BACKGROUND KNOWLEDGE



The point of the group discussion is to review summer training opportunities using the tips for answering / facilitating discussion and the suggested questions provided.

STAFF CADET ADVANCED TRAINING



The information below provides a brief introduction of what advanced training - staff cadet is and the types of opportunities exist. To obtain more detailed and up-to-date information, CATO 13-28, *Advanced Training—Staff Cadets* should be consulted prior to conducting this lesson.

CATO 13-28, *Advanced Training—Staff Cadets*, defines staff cadets as follows:

- Staff cadets are appointed to such rank as is authorized by the CO of a CSTC established to conduct summer training.
- On the authority of the CO of the CSTC, staff cadets may be requested to participate in advanced training, including instructional, supervisory or administrative functions that are approved by the Regional Cadet Support Unit (RCSU) CO for that training centre.
- Staff cadets may not be less than 16 years of age as of the first day of January of the year of advanced training.
- Staff cadets are not employees. Participation by the staff cadet during authorized CSTC summer training constitutes advanced training.



While staff cadets are not considered employees, they do receive pay during their time at a CSTC. Each position has a designated rank that corresponds to a pay incentive. For more details see Annexes B and E of CATO 13-28, *Advanced Training—Staff Cadets*.

Staff cadet classifications are divided into two distinct categories:

- Type 1—Training (eg, flight staff, instructor), and
- Type 2—Training Support (eg, administration clerk, supply clerk, accommodation, canteen).



Prerequisites are outlined in CATO 13-28, *Advanced Training—Staff Cadets* for each individual position.



A cadet who has attended one of these courses could be asked to speak about their experience during this TP.

CADET SUMMER TRAINING CENTRE (CSTC) COURSES

COMMON COURSES



Common courses are available to air, army, and sea cadets.



Refer to CATO 51-01, *Air Cadet Program Outline* for prerequisites.

Military Band–Advanced Musician. The aim of this course is to improve the cadets' music knowledge and skills and to prepare the cadets to assist in the delivery of music training for military band.

Pipe Band–Advanced Musician. The aim of this course is to improve the cadets' music knowledge and skills and to prepare the cadets to assist in the delivery of music training for pipe band.

ELEMENTAL COURSES

Power Pilot Scholarship. The Power Pilot Scholarship is a seven-week course of ground and flying training designed to qualify air cadets for a Transport Canada Private Pilot Licence in accordance with Canadian Air Regulations. Training is conducted by member flying schools or clubs of either the Air Transport Association of Canada or l'Association québécoise des transporteurs aériens.

International Air Cadet Exchange. The purpose of the exchange is to promote friendship and goodwill among air cadets of the participating countries, to encourage participants to develop an interest in international affairs and to reward those air cadets who have rendered outstanding service to their squadrons over a period of years. It is intended only for senior cadets who will represent Canada with distinction.

GROUP DISCUSSION



TIPS FOR ANSWERING / FACILITATING DISCUSSION:

- Establish ground rules for discussion, eg, everyone should listen respectfully; don't interrupt; only one person speaks at a time; no one's ideas should be made fun of; you can disagree with ideas but not with the person; try to understand others as much as you hope they understand you; etc.
- Sit the group in a circle, making sure all cadets can be seen by everyone else.
- Ask questions that will provoke thought; in other words avoid questions with yes or no answers.
- Manage time by ensuring the cadets stay on topic.
- Listen and respond in a way that indicates you have heard and understood the cadet. This can be done by paraphrasing their ideas.
- Give the cadets time to respond to your questions.
- Ensure every cadet has an opportunity to participate. One option is to go around the group and have each cadet answer the question with a short answer. Cadets must also have the option to pass if they wish.
- Additional questions should be prepared ahead of time.

SUGGESTED QUESTIONS:

- Q1. What is the age requirement for advanced training – staff cadet?
- Q2. What common CSTC courses are available to Proficiency Level Five cadets?



Other questions and answers will develop throughout the group discussion. The group discussion should not be limited to only those suggested.



Reinforce those answers given and comments made during the group discussion, ensuring the teaching point has been covered.

CONFIRMATION OF TEACHING POINT 3

The cadets' participation in the group discussion will serve as the confirmation for this TP.

Teaching Point 4**Review leadership assignment and leadership appointment opportunities at the squadron.**

Time: 5 min

Method: Group Discussion

BACKGROUND KNOWLEDGE

The point of the group discussion is to review leadership assignment and appointment opportunities in the squadron using the tips for answering / facilitating discussion and the suggested questions provided.

LEADERSHIP ASSIGNMENT

A leadership assignment is a specific, short or long-term practical leadership opportunity. The team leader must apply their leadership skills. The team leader will have temporary team members either within or outside their peer group. The team will accomplish a single minor duty or task.



Leadership assignments in Proficiency Level Five may be the same as Proficiency Level Three or of longer duration / complexity. Each cadet should have already completed at least three leadership assignments during Proficiency Level Three and Proficiency Level Four.

LEADERSHIP APPOINTMENT

A leadership appointment is a long-term practical leadership opportunity. The team leader must apply their leadership knowledge and skills and display the core leadership qualities of a cadet. The team leader will have an assigned, established team of cadets outside their peer group. These may be organizational appointments (eg, Flight Commander), training appointments (eg, Proficiency Level Instructor) or supplementary appointments (eg, Drill Team Commander). These appointments must be based on the frequency and duration of the major duties or tasks. The team leader must meet with their team on a number of occasions. Leadership appointments may be held by a single Proficiency Level Five cadet (eg, Drill Team Commander) or cadets may rotate through a position (eg, canteen clerk).

The team leader must supervise team members, communicate with team members and solve problems, strive to meet the needs and expectations of team members, motivate team members, and provide feedback to team members. The team leader must attempt to develop the skills and knowledge of their team members.

Direction for the leadership appointment must be given by a superior usually an activity leader or activity manager.



During Proficiency Level Five training, each cadet will be assessed at least once on a leadership assignment and once while fulfilling a leadership appointment.



Ensure a list of leadership appointments has been developed by the Training Officer before instructing this class. Below is a sample list of leadership appointments

SAMPLE PROFICIENCY LEVEL FIVE LEADERSHIP APPOINTMENTS

Organizational Appointments include:

- Flight Sergeant,
- Flight Commander,
- Squadron Commander,
- Drum Major, and
- Flag Party Commander.

Training Appointments include:

- Proficiency Level Instructor,
- Fitness and Sports Instructor,
- Drill and Ceremonial Instructor,
- Aviation Instructor, and
- Aircrew Survival Instructor.

Supplementary Appointments include:

- Drum Major,
- Band Section Leader,
- Canteen Steward,
- Drill Team Commander,
- Marksmanship Team Captain,
- Range Assistant,
- First Aid Team Captain,
- Biathlon Team Captain, and
- Sports Team Captain.



Proficiency Level Five cadets will typically be assigned the leadership appointments of Squadron Warrant Officer or supplementary appointments. As required, Proficiency Level Five cadets may be assigned various other organizational and training appointments.



For the purposes of PO 503 (Lead Cadets), Proficiency Level Five cadets will be required to fulfill a leadership appointment that meets the criteria defined above. This requires that the appointment involves an assigned, established team of cadets outside the Proficiency Level Five Cadet's peer group. In some circumstances, some of the examples given may not meet these criteria (eg, a smaller squadron that only have one cadet assigned to Supply).

GROUP DISCUSSION



TIPS FOR ANSWERING / FACILITATING DISCUSSION:

- Establish ground rules for discussion, eg, everyone should listen respectfully; don't interrupt; only one person speaks at a time; no one's ideas should be made fun of; you can disagree with ideas but not with the person; try to understand others as much as you hope they understand you; etc.
- Sit the group in a circle, making sure all cadets can be seen by everyone else.
- Ask questions that will provoke thought; in other words avoid questions with yes or no answers.
- Manage time by ensuring the cadets stay on topic.
- Listen and respond in a way that indicates you have heard and understood the cadet. This can be done by paraphrasing their ideas.
- Give the cadets time to respond to your questions.
- Ensure every cadet has an opportunity to participate. One option is to go around the group and have each cadet answer the question with a short answer. Cadets must also have the option to pass if they wish.
- Additional questions should be prepared ahead of time.

SUGGESTED QUESTIONS

- Q1. What is the difference between a leadership assignment and a leadership appointment?
- Q2. What leadership appointments are available at the squadron?
- Q3. Do you have any concerns knowing that you will fill a leadership appointment during this training year?



Other questions and answers will develop throughout the group discussion. The group discussion should not be limited to only those suggested.



Reinforce those answers given and comments made during the group discussion, ensuring the teaching point has been covered.

CONFIRMATION OF TEACHING POINT 4

The cadets' participation in the group discussion will serve as the confirmation of this TP.

Teaching Point 5**Explain the OJPR and Proficiency Level Five Logbook.**

Time: 20 min

Method: Interactive Lecture

On-the-Job Training (OJT)

To provide a suitably flexible and dynamic structure to OJT, the traditional period allocation and scheduling employed in previous levels of the CP does not apply. The cadet participates in authorized sessions and training days / weekends with the squadron. Within the 30 sessions and 10-day construct of the Squadron Program, all time beyond that required to complete mandatory and complementary training is allocated to OJT and completion of the different components of the Assessment of Learning Plan.

Under the supervision of the Proficiency Level Officer, or designated representative, the cadet completing OJT is responsible for performing a variety of leadership appointments, leadership assignments, leadership projects and instructional responsibilities. Cadets may also be assigned general administrative, support and supervision roles and responsibilities. While the unique nature of each squadron dictates the exact OJT experience a cadet will have, at a minimum the cadet shall be provided with suitable assessment for learning and assessment of learning opportunities as outlined in the Assessment of Learning Plan.

On-the-Job Practical Requirements (OJPR)

OJPR are the set of practical requirements needed to satisfy the assessment of learning plan. Practical requirements are a component of the following POs.

PO 502 (Perform Community Service)

The cadet is required to develop a community service plan describing how they will perform community service over the training year(s). The assessment of learning requires that cadets complete at least 45 hours of community service to complete this practical requirement without difficulty. If cadets complete 70 hours or more of community service, they have exceeded the standard.

PO 503 (Lead Cadet Activities)

The cadet is required to complete at least one leadership assignment, leadership appointment and leadership project during the training year(s). The assessment of learning provides details on how each task is evaluated. In addition to the three formal assessments, cadets are provided additional leadership assignments, appointments and projects through the course of their normal duties at the squadron.

PO 504 (Adopt an Active Lifestyle)

The cadet is required to complete a minimum of 60 minutes of moderate-to vigorous-intensity physical activity (MVPA) daily for 24 days over four consecutive weeks. If cadets complete a minimum of 60 minutes of MVPA daily for 28 days over four consecutive weeks, they have exceeded the standard.

PO 509 (Instruct Cadets)

The cadet is required to complete at least one formally assessed period of instruction during Proficiency Level Five. The assessment of learning provides details on evaluation. In addition to this formal assessment, cadets will be provided many additional opportunities to instruct through the course of their normal duties at the squadron.

PO 513 (Attend a Workshop)

The cadet will complete 18 periods of regionally facilitated workshops conducted during two full days, four half days or other equivalent combination of training.

PO 514 (Pursue Individual Learning)

The cadet is required to complete a minimum of one ILP over the course of the training year(s). The assessment of learning provides details on evaluation. The cadet's ILP must meet the criteria set out within the assessment activity instructions by identifying learning needs, learning activities, target dates, learning resources, measures of success and a final report description.

OJPR Logbook

A-CR-CCP-805/PW-001, *Royal Canadian Air Cadets Proficiency Level Five Logbook*, is provided to the cadet as a tool to help guide and track their progress. This tool serves as both an aide-memoire and personal log. The content of the Proficiency Level Five Logbook consists of a summary of pertinent information regarding OJT, OJPR, and requirements of the Assessment of Learning Plan and Assessment Instruments. It is intended that Proficiency Level Five cadets keep their logbook updated and seek guidance from their supervisor(s) to obtain the required signatures. Once completed, the Proficiency Level Five Logbook is retained by the cadet to record future service.

CONFIRMATION OF TEACHING POINT 5

QUESTIONS:

- Q1. Is Proficiency Level Five training scheduled in the same manner as previous years?
- Q2. What are the OJPR for PO 502 (Perform Community Service)?
- Q3. What will cadets do with their Proficiency Level Five Logbook upon completion of Proficiency Level Five?

ANTICIPATED ANSWERS:

- A1. No, to provide a suitably flexible and dynamic structure to OJT, the traditional period allocation and scheduling employed in previous levels of the cadet program do not apply.
- A2. The cadet is required to develop a community service plan describing how they will perform community service over the training year(s). The assessment of learning requires that cadets complete at least 45 hours of community service to complete this practical requirement without difficulty. If cadets complete 70 hours or more community service, they have exceeded the standard.
- A3. Once completed, the Proficiency Level Five Logbook is retained by the cadet to record future service.

Teaching Point 6

Have the cadets develop a personalized schedule.

Time: 30 min

Method: In-Class Activity

ACTIVITY

Time: 30 min

OBJECTIVE

The objective of this activity is to have the cadets develop a personalized schedule.

RESOURCES

- Proficiency Level Five Logbook,
- Current squadron training schedule, and

- Pen / pencil.

ACTIVITY LAYOUT

Nil.

ACTIVITY INSTRUCTIONS

1. Provide each cadet with a pen / pencil, current squadron training schedule and Proficiency Level Five Logbook.
2. Have the cadets complete the agenda section of their Proficiency Level Five Logbook, filling in the dates and months and year.
3. Have the cadets record the date(s) they are required to instruct at the squadron for the training year. Remind cadets that this information is subject to changes in the training schedule and should be updated as required.
4. Have the cadets record any other squadron commitments where they are required to attend. For example, they may be appointed marksmanship assistant as a leadership appointment and marksmanship practices occur each week on Wednesday evenings.
5. Have cadets record their school, work or extracurricular activities as required.
6. Discuss with the cadets the importance of managing their time effectively and using their agenda to record other commitments as they occur. The date and time of community service commitments, when they will work on their leadership project with their team and milestones of their ILP can all be recorded in the agenda.
7. Allow the cadets the remaining time to add other items to their personalized schedule while providing assistance and guidance as required.

SAFETY

Nil.

CONFIRMATION OF TEACHING POINT 6

The cadets' participation in the in-class activity will serve as the confirmation of this TP.

END OF LESSON CONFIRMATION

The cadets' production of a personalized schedule will serve as the confirmation of the lesson.

CONCLUSION

HOMEWORK / READING / PRACTICE

Nil.

METHOD OF EVALUATION

Nil.

CLOSING STATEMENT

Being aware of the topics to be covered during Proficiency Level Five training will help generate interest in the training year. Being aware of the time requirements needed to complete Proficiency Level Five will ensure you are able to balance the cadet activities with other activities and achieve success in both.

INSTRUCTOR NOTES / REMARKS

This EO should be scheduled as early as possible in the training year.

REFERENCES

A0-035 CATO 13-28 Director Cadets 2. (2006). *Advanced training–Staff cadet*. Ottawa, ON: Department of National Defence.

A0-096 CATO 11-04 Director Cadets 3. (2007). *Cadet program outline*. Ottawa, ON: Department of National Defence.

A3-029 CATO 51-01 Director Cadets Senior Staff Officer Air Cadets. (2009). *Air cadet program outline*. Ottawa, ON: Department of National Defence.

A3-184 A-CR-CCP-805/PW-001 Director Cadets 3. (2009). *Royal Canadian Air Cadets proficiency level five logbook*. Ottawa, ON: Department of National Defence.

A3-185 A-CR-CCP-803/PG-001 Director Cadets 3. (2008). *Royal Canadian Air Cadets Proficiency Level Three Qualification Standard and Plan*. Ottawa, ON: Department of National Defence.

A3-186 A-CR-CCP-804/PG-001 Director Cadets 3. (2009). *Royal Canadian Air Cadets Proficiency Level Four Qualification Standard and Plan*. Ottawa, ON: Department of National Defence.

PROFICIENCY LEVEL FIVE POs AND EOs	
Citizenship PO 501 (Explain Global Citizenship)	
C501.01	Reflect Upon What it Means to be a Good Canadian Citizen
C501.02	Reflect on Individual Global Citizenship
C501.03	Develop an Awareness of Global Issues
Community Service PO 502 (Perform Community Service)	
M502.01	Perform 45 Hours of Individual of Community Service
Leadership PO 503 (Lead Cadet Activities)	
M503.01	Create a Proposal
M503.02	Prepare for an Exercise
M503.03	Conduct an Exercise
M503.04	Conclude an Exercise
C503.01	Analyze an Exercise Plan
Personal Fitness and Healthy Living PO 504 (Adopt an Active Lifestyle)	
M504.01	Participate in the Cadet Fitness Assessment and Identify Strategies for Improving Personal Physical Fitness
C504.01	Reflect on Personal Fitness and Healthy Living
General Cadet Knowledge PO 507 (Serve in an Air Cadet Squadron)	
M507.01	Develop a Personalized Schedule
C507.01	Identify Service Opportunities as a Cadet Instructors Cadre Officer
C507.02	Identify Volunteer Opportunities With the Air Cadet League of Canada (ACLCL)
C507.03	Reflect on the Cadet Experience
Instructional Techniques PO 509 (Instruct Cadets)	
C509.01	Monitor Instruction
Professional Development PO 513 (Attend a Workshop)	
Personal Development PO 514 (Pursue Individual Learning)	
Airmanship PO 530 (Fly a Cross-Country Flight Using a Flight Simulator)	
C530.01	Fly a Cross-Country Flight Using a Flight Simulator
Aerospace PO 540 (Reflect on Canada's Contribution to Aerospace Technology)	
C540.01	Reflect on Canada's Contribution to Aerospace Technology
Aerodrome Operations PO 560 (Participate in an Aerodrome Operations Activity)	
C560.01	Examine Aspects of Flight Safety (FS)
C560.02	Examine the Canadian Bush Pilot Industry

PROFICIENCY LEVEL FIVE POs AND EOs	
Aircraft Manufacturing and Maintenance PO 570 (Examine Aspects of Aircraft Manufacturing and Maintenance Through the Development of Aerobatic Aircraft)	
C570.01	Examine Aspects of Aircraft Manufacturing and Maintenance Through the Development of Aerobatic Aircraft
Aircrew Survival PO 590 (Analyze an Aircrew Survival Case Study)	
C590.01	Analyze an Aircrew Survival Case Study



**COMMON TRAINING
PROFICIENCY LEVEL FIVE
INSTRUCTIONAL GUIDE**



SECTION 2

**EO C507.01 – IDENTIFY SERVICE OPPORTUNITIES
FOR A CADET INSTRUCTORS CADRE (CIC) OFFICER**

Total Time:

90 min

PREPARATION

PRE-LESSON INSTRUCTIONS

Resources needed for the completion of this self-study package are listed in the lesson specification located in A-CR-CCP-805/PG-001, *Proficiency Level Five Qualification Standard and Plan*, Chapter 4. Specific uses for said resources are identified throughout the self-study package within the section for which they are required.

Self-study packages are intended to be completed by the cadet independently. More information about self-study packages can be found in the foreword and preface.

Review the lesson content and become familiar with the material prior to facilitating this lesson.

Photocopy the self-study package located at Attachment A for each cadet.

Photocopy the answer key located at Attachment B but **do not** provide it to the cadet.

PRE-LESSON ASSIGNMENT

Nil.

APPROACH

A self study was chosen for this lesson as it allows the cadet to examine in greater detail service opportunities for a CIC officer at their own learning pace. This encourages the cadet to become more self-reliant and independent by focusing on their own learning instead of learning directed by the instructor.

INTRODUCTION

REVIEW

Nil.

OBJECTIVES

By the end of this lesson the cadet shall be expected to have identified service opportunities for a CIC officer.

IMPORTANCE

It is important for cadets to be aware of the various service opportunities for a CIC officer if they choose to enrol as a CIC officer. By being aware of these opportunities, they will be able to make a more informed decision about enrolling and what direction they want their service to take.

SELF-STUDY PACKAGE INSTRUCTIONS

OBJECTIVE

The objective of this self-study package is to have the cadet identify service opportunities for a CIC officer.

RESOURCES

- Self-study package, and
- Pen / pencil.

ACTIVITY LAYOUT

Provide the cadet with a classroom or training area suitable to complete the self-study package.

ACTIVITY INSTRUCTIONS

1. Provide the cadet with a copy of the self-study package located at Attachment A and a pen / pencil.
2. Allow the cadet 90 minutes to complete the self-study package.
3. Provide assistance as required to the cadet.
4. Collect the self-study package once the cadet has finished.
5. Correct the self-study package with the self-study package answer key located at Attachment B.
6. Provide feedback to the cadet and indicate whether or not they have completed the Enabling Objective (EO).
7. Return the completed self-study package to the cadet for their future reference.
8. Upon completion of the self-study package, record the result in the cadet's logbook and Cadet Training Record.

SAFETY

Nil.

END OF LESSON CONFIRMATION

The cadet's completion of the self-study package will serve as the confirmation of this lesson.

CONCLUSION

HOMEWORK / READING / PRACTICE

Nil.

METHOD OF EVALUATION

Nil.

CLOSING STATEMENT

A decision to serve in the Canadian Forces (CF) must not be made lightly. A decision to serve as a CIC officer can be made easier by identifying the various ways that CIC officers are employed.

INSTRUCTOR NOTES / REMARKS

Nil.

REFERENCES

A0-096 CATO 11-04 Director Cadets 3. (2007). *Cadet program outline*. Ottawa, ON: Department of National Defence.

A0-194 CATO 23-01 Director Cadets 6. (2007). *Recruitment / enrolment–Officers of the cadet instructors cadre (CIC)*. Ottawa, ON: Department of National Defence.

A0-195 CATO 21-03 Director Cadets 2. (2007). *Corps / squadron establishments staffing priorities and authorized paid days*. Ottawa, ON: Department of National Defence.

A0-196 CATO 23-11 Director Cadets 6. (2007). *Cadet instructors supporting cadet activities without pay*. Ottawa, ON: Department of National Defence.

A0-197 CATO 23-10 Director Cadets 2. (2006). *Reserve service opportunity selection process*. Ottawa, ON: Department of National Defence.

A0-198 Department of National Defence. (2009). *Reserve service opportunities*. Retrieved October 29, 2009, from <http://www.cadets.ca/employment-emploi.aspx>

A0-199 Department of National Defence. (2009). *CIC–Cadet instructors cadre*. Retrieved October 29, 2009, from <http://www.vcds.forces.gc.ca/cic/index-eng.asp>

A1-066 CATO 31-03 Director Cadets Senior Staff Officer Sea Cadets. (2008). *Sea cadet program outline*. Ottawa, ON: Department of National Defence.

A2-031 CATO 40-01 Director Cadets Senior Staff Officer Army Cadets. (2009). *Army cadet program outline*. Ottawa, ON: Department of National Defence.

A3-029 CATO 51-01 Director Cadets Senior Staff Officer Air Cadets. (2009). *Air cadet program outline*. Ottawa, ON: Department of National Defence.

Identify Service Opportunities for a Cadet Instructors Cadre (CIC) Officer



SECTION 1: ENROLMENT STANDARDS FOR THE CIC

SECTION 2: CORPS / SQUADRON SERVICE OPPORTUNITIES

SECTION 3: REGIONAL SERVICE OPPORTUNITIES

SECTION 4: CADET SUMMER TRAINING CENTRE (CSTC) SERVICE OPPORTUNITIES

SECTION 5: NATIONAL SERVICE OPPORTUNITIES

SECTION 1
ENROLMENT STANDARDS FOR THE CIC

THE CIC MILITARY OCCUPATION STRUCTURE IDENTIFICATION (MOSID)

The CIC is a Personnel Branch of the Canadian Forces (CF). It celebrated its 100th anniversary in 2009 making it one of the oldest components of the CF. Every member of the CF belongs to an occupation or trade and CIC officers are no exception. Each trade is assigned an identification code. The Cadet Instructors Cadre officers' MOSID is 00232-01 for naval elemental officers, 00232-02 for army elemental officers and 00232-03 for air elemental officers.



Figure A-1 CIC Branch Flag

Note. From Cadets Canada, 2010, *CIC Branch Flag*. Retrieved February 19, 2010, from <http://www.cadets.ca/content-contenu.aspx?id=80615>

The CIC is the largest Personnel Branch of the CF with numbers in excess of 6000 members. Officers of the CIC, as CF members, fall under the authority of the *National Defence Act*, the law which governs Canada's military, and are subject to the same rules and regulations as any other member of the reserve force or regular force. This obligation to maintain a high standard of personal conduct is important as in many communities throughout Canada, the CIC may be the only uniformed members of the CF, and as such, reflect the CF as a whole.

	Have any of your friends enrolled in the CIC?

CADET ORGANIZATIONS ADMINISTRATION AND TRAINING SERVICE (COATS)

The CF is composed of two main forces: the regular force and the reserve force. The regular force (Reg F) consists of full-time members of Canada's military. The reserve force consists of members who, while still members of the military, serve part-time. The reserve force is composed of the Primary Reserve (P Res), Supplemental Reserve (Supp Res), Canadian Rangers (Rangers) and COATS. Members of the P Res are trained in similar occupations available to Reg F members. The Supp Res acts as a holding list of recently released CF members who may, in the event of a national emergency or as operationally required, be recalled to active service. Rangers provide a military presence in remote, isolated and coastal communities of Canada. Its members are trained to perform their unique roles as the eyes and ears of the CF in those areas. COATS consists of members of the CIC as well as other members of the CF not belonging to the CIC MOSID who work with the Canadian Cadet Organizations (CCO). In addition to the CIC MOSID, COATS includes two other occupations: General Service Officer (COATS GS-OFF) and General Service Non-Commissioned Member (COATS GS-NCM). COATS GS-OFF and COATS GS-NCM MOSIDS exist to allow Reg F and P Res officers and NCMs to transfer to another sub-component for employment in support of the Cadet Program (CP). This ensures the CF that these trained and experienced members can be retained to assist with the management, administration and delivery of the CP.

BASIC ENROLMENT STANDARDS

To be eligible for enrolment within a CIC MOSID, an individual must:

- be a Canadian citizen;
- be of good character and standing in the community and recommended by a cadet organization commanding officer, parent committee or the corresponding provincial league;
- have reached the minimum enrolment age of 18 and be able to complete at least one year of service before reaching the CIC Compulsory Retirement Age (CRA) of 65;
- meet the medical standards prescribed in CANFORGEN 070/07. Normally, the applicant must have a medical category no lower than V4 CV3 H3 G3 O3 A5. An applicant with a medical category below this standard but not lower than V4 CV3 H4 G4 O4 A5 may be accepted if the command surgeon approves the medical limitations and certifies that any medical condition will not be aggravated by military service; and



Did you know?

The Medical Category System in the CF assigns numerical values to Visual Acuity (V), Color Vision (CV), Hearing (H), Geographical Factor (G), Occupational Factor (O) and Air Factor (A). A lower value indicates a higher ability within the category. The CIC Medical Category is therefore less restrictive than, for example, a pilot for which V1 CV2 H2 G2 O2 A1 is the lowest acceptable category.

- have a high school diploma or equivalent. In exceptional circumstances, with the approval of Director Cadets and Junior Canadian Rangers (D Cdts & JCR), an applicant who does not hold a high school diploma may be enrolled. Education waivers shall only be granted in situations where the CCO benefits.



Activate Your Brain #1:

Are CIC officers members of the CF?



Activate Your Brain #2:

What education requirements are needed for enrolment in the CIC?

SECTION 2
CORPS / SQUADRON SERVICE OPPORTUNITIES

CORPS / SQUADRON

Corps / Squadron Establishments

The majority of CIC officers serve within corps and squadrons across Canada. Each corps / squadron has an authorized establishment, a collection of all military and civilian positions within an authorized organizational structure of the Department of National Defence (DND). Corps / squadron establishments are linked to corps / squadron quotas as determined by CATO 12-21, *Cadet Corps / Squadrons Annual Report*. The number of allocated positions on a corps / squadron establishment as determined by corps / squadron quota can be found in CATO 21-03, *Cadet Corps / Squadron Establishments Staffing Priorities and Authorized Paid Days*.

Corps / Squadron Quota as determined by CATO 12-21	Cadet Corps / Squadron Automated Establishment Report (AER)– Authorized Paid CIC Positions by Rank			Total Number of Paid CIC Positions on AER	Authorized Specialist Days
A	B	C	D	E	F
	Maj/LCdr	Capt/Lt(N)	Capt/Lt(N)/ Lt/ SLt / 2Lt/ASlt / OCdt / NCdt		
< 30		1	4	5	5 days
30–59		2	4	6	6 days
60–89		2	5	7	7 days
90–119	1	2	5	8	8 days
120–149	1	3	5	9	9 days
150–179	1	3	6	10	10 days
180–209	1	4	6	11	11 days
210–239	1	4	7	12	12 days
240–269	1	4	8	13	13 days
270–299	1	5	8	14	14 days
> 300	1	6	8	15	15 days

Figure A-2 CIC Paid Positions Scale–Corps/Squadron Establishments and Specialist Days

Note. From *Cadet Corps / Squadron Establishments Staffing Priorities and Authorized Paid Pays* (p. A-1/2), by Director Cadets 2, 2007, Ottawa, ON: Department of National Defence.

If a cadet corps / squadron has a vacancy on their establishment, a new CIC officer can be enrolled and fill one of these positions. If no position exists, the new CIC officer may be enrolled and fill a position on a regional / detachment holding list and volunteer with the cadet corps / squadron.



Figure A-3 CIC Corps / Squadron Officer

Note. From Cadets Canada, 2010, *About the CIC*. Retrieved February 19, 2010, from <http://www.cadets.ca/assets/0/121/401/2421/3811/a75e2dac-7cd5-4914-82b6-553ee43f0c80.jpg>

Paid Days

Commanding officers of a corps / squadron can be paid up to 35 days per year with all other officers on strength being eligible for 25 days per year. CIC officers on holding lists / regional establishments that are volunteering at a corps / squadron are only paid when hired for service outside the corps / squadron. As positions on a corps / squadron establishment become available volunteering CIC officers may be transferred to it. In addition to the maximum paid days for corps / squadron training, a CIC officer may be paid for additional Class A or Class B reserve service while attending a course or performing other duties.



Did you know?

There are three classes of reserve service.

- **Class A Service.** Class A service is used for periods of employment not exceeding 12 days. CIC officers are frequently employed on Class A service, for example, corps / squadron pay each month, working two days at a marksmanship competition, etc.
- **Class B Service.** Class B service is used for periods of employment over 13 days. For any Class B Service over 90 days a job posting message must be advertised to allow qualified individuals to express their interest in the position. CIC officers are sometimes employed on Class B service, for example, attending a CIC training course (for 15 days), working at a CSTC (for more than 12 days), working a four-month temporary position at a regional headquarters, assuming a full-time position of Area Cadet Officer (ACO) at a detachment / region, etc.
- **Class C Service.** Class C service is used when P Res members employed full time in an operational capacity. It may also be used, under exceptional circumstances, when a reservist is serving in a non-operational Reg F position. CIC officers are never employed on Class C service and even P Res members require approval from the Vice-Chief of Defence Staff (VCDS).

TECHNICAL TRAINING ESTABLISHMENTS

Technical training establishments are training centres that are required to augment the corps / squadron program by providing specialized training not available at each corps / squadron. Without technical training establishments, cadets would not be able to satisfy the minimum requirements of mandatory training. Each technical training establishment is run by a coordinator, selected by the region, to plan and deliver training at their centre. Most of these coordinators are also corps / squadron CIC officers. They select and hire other CIC officers on Class A service as staff.

Regional Cadet Sailing Schools (Sail Centres)

Sail centres augment sea cadet phase training by providing sail training and on-the-water opportunities not available at a corps. Opportunities exist at sail centres for CIC officers to be employed as sail centre coordinators or sail centre instructional staff. The maximum number of paid days varies by region and position. Each sail centre uses the same instructional staff to maintain continuity and to build a pool of experienced instructors familiar with the specific centre.



Figure A-4 Sail Centre Training

Note. From Regional Cadet Support Unit (Eastern), 2010, *Eastern Region Nautical Training*. Retrieved February 19, 2010, from <http://cms.cadets.gc.ca/assets/0/121/423/427/443/3403/3421/3423/3439/a409501d-5351-4a6c-be4a-952fcfdb5e8f.jpg>

Regional Army Cadet Expedition Centres (Expedition Centres)

Expedition centres augment the army cadet star program by providing navigation training and expedition opportunities not available at a corps. Opportunities exist at expedition centres for CIC officers to be employed as expedition centre coordinators or instructional staff. The maximum number of paid days varies by region and position. Each expedition centre uses the same instructional staff to maintain continuity and to build a pool of experienced instructors familiar with the specific centre.



Figure A-5 Expedition Centre Training

Note. From Regional Cadet Support Unit (Prairie), 2010, *Program Description*. Retrieved February 19, 2010, from <http://www.cadets.ca/assets/0/121/379/3617/9166/e1eb1423-e31f-4f23-a707-e0fc93ef52ec.jpg>

Regional Cadet Air Operations (Gliding Centres)

Gliding centres operate year-round in support of the squadron program and summer training. Gliding centres augment the air cadet proficiency level program by providing aviation training and gliding opportunities not available at a squadron. Opportunities exist at gliding centres for CIC officers to be employed as gliding centre coordinators, pilots, ground crew or instructional staff. The maximum number of paid days varies by region and position. Each gliding centre uses the same instructional staff to maintain continuity and to build a pool of experienced instructors familiar with the specific centre. During the summer months, the 5 regional centres operate as CSTCs and are responsible for delivering programs which may include Basic Aviation, Advanced Aviation, Glider Pilot Scholarship and Power Pilot Scholarship.



Figure A-6 Gliding Centre Training

Note. From Cadets Canada, 2010, *Air Cadet 2009 CSTC Course Listings*. Retrieved February 19, 2010, from <http://www.cadets.ca/assets/0/121/401/2421/3811/79dc086b-d5f2-4ee6-9526-81c7492440c1.jpg>



Have any of your friends worked at a technical training establishment?



Activate Your Brain #3:

How many paid positions are there on the establishment of a corps / squadron with less than 30 cadets?



Activate Your Brain #4:

What is Class A service?

SECTION 3 REGIONAL SERVICE OPPORTUNITIES

REGIONALLY DIRECTED ACTIVITIES (RDAs)

RDAs are activities that Regional Cadet Support Unit (RCSU) COs conduct annually within their regions. RDAs augment the corps / squadron program by maintaining the cadets' interest in specific areas of cadet training and allow RCSU COs to tailor the overall CP to match regional interests and capitalize on regional opportunities and resources. RDAs fall into two categories: non-discretionary and discretionary. Many RDAs require the support of corps / squadron officers to plan and implement and are hired on Class A service.



Figure A-7 Provincial Biathlon Championships

Note. From Trek Earth, 2010, *Photos*. Retrieved February 19, 2010, from <http://www.trekearth.com/gallery/photo320887>

Non-discretionary

Non-discretionary RDAs include regional activities used to select cadets for national competitions and as such must be funded and conducted. Non-discretionary RDAs include:

- zone, provincial and / or regional marksmanship championships,
- zone, provincial and / or regional biathlon championships,
- inter-provincial exchanges,
- sea cadet program zone, provincial and / or regional regattas, and
- army cadet program regional expeditions.

For regions to facilitate these events, CIC officers are hired on Class A service. In many cases, individuals selected for service are asked to return in future years based on performance, as well as a need to train a base of experienced personnel.

Discretionary

In addition to activities programmed in the corps / squadron program, other activities may be organized, funded and conducted under the supervision of the RCSU, as determined by the RCSU CO. Selected activities must be focused on achieving the CP aim. Possible activities include:

- drill and ceremonial activities, such as ceremonial parades and / or drill competitions;
- leadership training activities, such as senior cadet training concentrations or effective speaking competitions;
- recreational sports activities, such as inter-corps / squadron competitions, tabloid sports, etc;
- air rifle marksmanship activities, such as training sessions, competitions and / or civilian events;
- additional summer / winter biathlon activities, such as training sessions, competitions and / or civilian events;
- music training activities, such as training sessions, honour bands, and / or band competitions for both military bands and pipe bands;
- first aid activities, such as training courses and / or competitions;
- CF familiarization activities, such as visits to CF facilities, C7 rifle firing, attending CF displays or demonstrations, interacting with CF members or units, etc;
- Duke of Edinburgh's Award Program activities, such as briefings or presentations to corps / squadron staff.

	Now that you know what RDAs are, list the ones you've participated in during your cadet training.
<hr/>	
<hr/>	
<hr/>	
<hr/>	
<hr/>	

As with non-discretionary RDAs, in order for regions to facilitate these events, CIC officers are hired on Class A service. In many cases, individuals selected for service are asked to return in future years based on performance as well as a need to train personnel.



Activate Your Brain #5:

What is the difference between non-discretionary and discretionary RDAs?

CADET DETACHMENT / REGIONAL CADET SUPPORT UNIT (RCSU)

Many of the positions at cadet detachments / RCSUs are filled by CIC officers who perform full-time Class B service. They are selected based on their qualifications and experience with the CP. They assist in the management of CP on behalf of the RCSU CO and work alongside other Reg F and P Res members.

Cadet Detachment

Cadet detachments are found in some regions and serve as a way to better manage cadet corps / squadrons. Detachments are led by a detachment commander who manages a staff of officers and NCMs who are responsible for all the cadet corps / squadrons in that area. The cadet detachments are primarily involved in the implementation of the CP within the region and their staff perform tasks, such as claims, travel arrangements and approving training activities proposed by corps / squadron commanding officers.

Positions at cadet detachments that CIC officers could fill include ACO, Detachment Movements Officer or Detachment Commander. Positions will vary by region and detachment.

Regional Cadet Support Unit (RCSU)

The CP in Canada is delivered by six RCSUs spread across the country.

- RCSU (Atlantic)–RCSU (A) includes all cadet units in the provinces of Nova Scotia, New Brunswick, Prince Edward Island and Newfoundland and Labrador,
- RCSU (Eastern)–RCSU (E) includes all cadet units in the province of Quebec and Air Cadet Squadrons in the Ottawa Valley area,
- RCSU (Central)–RCSU (C) includes all cadet units in the province of Ontario except Air Cadet Squadrons in the Ottawa Valley and all corps / squadrons in northwestern Ontario,
- RCSU (Prairie)–RCSU (Pra) includes all cadet units in the provinces of Manitoba, Saskatchewan and Alberta and all corps / squadrons in northwestern Ontario,
- RCSU (Pacific)–RCSU (P) includes all cadet units in the province of British Columbia, and
- RCSU (Northern)–RCSU (N) includes all cadet units in the territories of Yukon, Northwest Territories and Nunavut).

Regions are led by a CO who manage a staff of officers and NCMs that are responsible for all the cadet corps / squadrons in that region. RCSUs are primarily involved in the management and financial budgeting of the CP within the region and their staff performs tasks, such as pay, human resource management, budgets, staff selections and directing training activities for both the corps / squadron program, as well as the CSTC program.

Positions at RCSUs that CIC officers could fill include Regional Training Officer(s), Regional Common Training Officer, Regional Movements Officer or Regional Administration / Human Resources Officer. Positions will vary by region as each RCSU is organized differently.



Activate Your Brain #6:

What types of positions could a CIC officer fill at an RCSU?

Regional Cadet Instructor School (RCIS)

Each region, with the exception of Northern, has a school for the training of CIC officers: RCIS (A) for Atlantic region, RCIS (E) for Eastern region, etc. Although each school is organized slightly differently, there are many similar positions available to CIC officers. A commandant oversees all aspects of the school and performs full-time Class B service. At most RCISs, a Standards Officer and Administration Officer also perform full-time Class B service. To augment this core staff, CIC officers are hired for either part-time or full-time Class A or Class B service to act as Directing Staff (DS) for courses being conducted.



Figure A-8 RCIS Training

Note. From Regional Cadet Support Unit (Pacific), 2010, *LTQ Course Info*. Retrieved February 19, 2010, from <http://cms.cadets.gc.ca/assets/0/121/381/1607/5120/6830/2bfaa598-e73e-4a55-9ea3-678859fa4159.jpg>

CIC officers selected to serve as DS at an RCIS are chosen for their knowledge and skill in presenting creative and effective lessons to the CIC officers on course. Depending on the course being presented, DS are selected for their specific expertise in an area of the CP (such as orienteering, paddling, abseiling, flying, sailing, etc.) Serving as DS at an RCIS may be a long-term or short-term service opportunity and is an excellent tool to develop as a CIC officer.



Did you know?

As a CIC officer, the first training course you complete is the Basic Officer Training Course (BOTC). BOTC provides new CIC officers with the training required to function as a member of the CIC within the CF and covers policies, regulations, drill, etc. RCISs offer the BOTC several times throughout the year.

SECTION 4

CADET SUMMER TRAINING CENTRE (CSTC) SERVICE OPPORTUNITIES

CSTC Service Opportunities

The CSTC program is integral to the overall CP and focuses on giving a portion of the cadet population instruction and opportunities to develop advanced knowledge and skills in specialized activities. It also develops instructors / leaders for these specialized activities for all components of the CP. CSTCs are staffed by CIC officers on Class B service who administer and supervise all aspects of the training centre. Some CSTCs have a small number of full-time staff officers that work during the training year to ensure the CSTC is ready to train cadets during the summer.

Each region selects CIC officers for CSTCs. A list of available positions is published in the fall and applications are sought from CIC officers interested in employment. During the winter, selection boards are held to sort through applications and decide which applicants are best suited for the various positions. In the spring, a list of those CIC officers selected for employment is published.



Figure A-9 CSTC Training

Note. From HMCS ACADIA, 2010, *Photo Gallery*. Retrieved February 19, 2010, from http://www.cadets.ca/cstc/acadia/photogallery.aspx#ctl00_ContentPlaceholder1_ImageGallery1_ImageDirectory

As the requirements of each CSTC are different, positions available will differ. General categories of jobs; however, are universal and may include:

- Divisional Officers / Platoon Commanders / Flight Commanders are responsible for the day-to-day supervision and instruction of cadets attending a course at a CSTC. They deal with a range of issues and they are the first contact for cadets' problems. Most first-year CIC officers are employed as Divisional Officers / Platoon Commanders / Flight Commanders.

- Duty Officers / Accommodations Officers / Barracks Supervisors are responsible for supervising cadets during non-training hours. They are usually organized in shifts and may work days or nights. First-year CIC officers are commonly employed as Duty Officers / Accommodations Officers / Barracks Supervisors as the experience in supervising develops their abilities and prepares them for further employment in positions of greater responsibility.
- Training Support positions often fall outside the various training departments / companies / squadrons and serve to augment the division / platoon / flight staff when conducting specialized training. Some CSTCs have training support positions in fitness and sports, range, drill and ceremonial, adventure training, canoeing, flight operations, sea operations, etc.
- Service Support positions comprise all the other logistical and administrative jobs required to operate the CSTC. Some examples of Service Support positions include supply, administration, banking / pay, food services, transportation, etc.

Many CIC officers choose to augment their service at a corps / squadron by serving at a CSTC. While not required, it can be an effective way to further one's own knowledge of the CP.

	<p>Activate Your Brain #7:</p> <p>What are some examples of Training Support positions at a CSTC?</p> <hr/> <hr/> <hr/>
---	--

SECTION 5
NATIONAL SERVICE OPPORTUNITIES

NATIONALLY DIRECTED ACTIVITIES (NDAs)

NDAs are activities that D Cds & JCR and the elemental program Senior Staff Officers (SSOs) chose to institute at a national level. NDAs augment the corps / squadron program by maintaining the cadets' interest in specific areas of cadet training and allow elemental SSOs to tailor the overall CP to match elemental interests, capitalize on national and international opportunities and resources. Many NDAs require the support of corps / squadron officers to plan and implement and are hired on Class A service.

Established NDAs include, but are not limited to:

- the national cadet air rifle championship;
- the national cadet winter biathlon championship;
- sea, army and air cadet international exchange programs;
- sea cadet deployments on board Her Majesty's Canadian Ships (HMCS), Coast Guard Ships, etc.;
- the national sea cadet regatta;
- the sea cadet national tall ship deployment;
- the sea cadet seamanship concentration;
- the army cadet program domestic expedition;

- the army cadet program international expedition; and
- the air cadet program Oshkosh Trip.

All CIC officers are eligible for employment on NDAs and are selected based on their knowledge and experience in the NDA's subject material.



Figure A-10 National Marksmanship Championships

Note. From Cadets Canada, 2010, *National Cadet Marksmanship Championship 2009*. Retrieved February 19, 2010, from [http://www.cadets.ca/uploadedImages/Cadet_Websites/National/Competitions/Marksmanship/Daily_Updates/15%20may%20daily%20update\(1\).JPG?n=4681](http://www.cadets.ca/uploadedImages/Cadet_Websites/National/Competitions/Marksmanship/Daily_Updates/15%20may%20daily%20update(1).JPG?n=4681)



Now that you know what NDAs are, have you participated in any during your cadet training? If so, list them.

DIRECTORATE CADETS AND JUNIOR CANADIAN RANGERS (D CDTS & JCR)

D Cdts & JCR is the national organization that administers, designs, coordinates and provides national support to all aspects of the CP in Canada. As well, it decides policy and designs and coordinates training for CIC officers. Its staff are comprised of Reg F, P Res officers and NCMs, as well as many CIC officers. CIC officers within D Cdts & JCR work on full-time Class B service and perform duties ranging from CP development to infrastructure management. At times, the D Cdts and JCR permanent staff are augmented by CIC officers, from across the country, to work on various focus groups, design projects and writing boards. These additional opportunities range from a few weeks to several months in length.



Activate Your Brain #8:

For what is D Cdts and JCR responsible?



Congratulations, you have completed your self-study package on EO C507.01 (Identify Service Opportunities for a Cadet Instructors Cadre (CIC) Officer). Complete the following exercise and hand your completed package to the Training Officer / Proficiency Level Officer who will record your completion in your Proficiency Level Five logbook.

FINAL EXERCISE

Cadet's Name: _____ Date: _____

1. What are the basic enrolment standards for members of the CIC?

2. How many paid positions are there on the establishment of a cadet corps / squadron with 100 cadets?

3. Define Class B service.

4. What is the purpose of a gliding centre?

5. What positions are available at a cadet detachment for a CIC officer?

6. List six NDAs.

THIS PAGE INTENTIONALLY LEFT BLANK

ACTIVATE YOUR BRAIN ANSWER KEY



Activate Your Brain #1:

Are CIC officers members of the CF?

The CIC is the largest Personnel Branch of the CF with numbers in excess of 6000 members. Officers of the CIC, as CF members, fall under the authority of the *National Defence Act*, the law which governs Canada's military, and are subject to the same rules and regulations as any other member of the reserve force or regular force.



Activate Your Brain #2:

What education requirements are needed for enrolment in the CIC?

To be eligible for enrolment in the CIC you must have a high school diploma or equivalent. In exceptional circumstances, with the approval of Director Cadets and Junior Canadian Rangers (D Cdts & JCR), an applicant who does not hold a high school diploma may be enrolled. Education waivers shall only be granted in situations where the CCO will benefit.



Activate Your Brain #3:

How many paid positions are there on the establishment of a corps / squadron with less than 30 cadets?

There are five paid positions on the establishment of a corps / squadron with less than 30 cadets.



Activate Your Brain #4:

What is Class A service?

Class A service is used for periods of employment not exceeding 12 days. CIC officers are frequently employed on Class A service, for example, corps / squadron pay each month, working two days at a marksmanship competition, etc.



Activate Your Brain #5:

What is the difference between non-discretionary and discretionary RDAs?

Non-discretionary RDAs include regional activities used to select cadets for national competitions and as such must be funded and conducted. In addition to activities programmed in the corps / squadron program, other activities may be organized, funded and conducted, under the supervision of the RCSU, as determined by the RCSU CO. These activities are considered discretionary.



Activate Your Brain #6:

What types of positions could a CIC officer fill at an RCSU?

Positions at RCSUs that CIC officer could fill include Regional Training Officer(s), Regional Common Training Officer, Regional Movements Officer or Regional Administration / Human Resources Officer. Positions will vary by region as each RCSU is organized differently.



Activate Your Brain #7:

What are some examples of Training Support positions at a CSTC?

Training Support positions often fall outside the various training departments / companies / squadrons and serve to augment the division / platoon / flight staff when conducting specialized training. Some CSTCs have training support positions in fitness and sports, range, drill and ceremonial, adventure training, canoeing, flight operations, sea operations, etc.

FINAL EXERCISE ANSWER KEY

1. What are the basic enrollment standards for the CIC?

To be eligible for enrollment within the CIC MOSID an individual must be a Canadian citizen, of good character and standing in the community and recommended by a cadet organization commanding officer, parent committee or the corresponding provincial league, have reached the minimum enrolment age of 18 and be able to complete at least one year of service before reaching the CIC Compulsory Retirement Age (CRA) of 65, meet the medical standards prescribed in CANFORGEN 070/07 and have a high school diploma or equivalent.

2. How many paid positions are there on the establishment of a cadet corps / squadron with 100 cadets?

There are eight paid positions on a 100-member corps / squadrons' establishment.

3. Define Class B service.

Class B service is used for periods of employment over 13 days. For any Class B Service over 90 days a job posting message must be advertised to allow qualified individuals to express their interest in the position. CIC officers are sometimes employed on Class B service, for example, attending a CIC training course (for 15 days), working at a CSTC (for more than 12 days), working a four-month temporary position at a regional headquarters, assuming a full-time position of Area Cadet Officer (ACO) at a detachment / region, etc.

4. What is the purpose of a Gliding Centre?

Gliding centres operate year-round in support of the squadron program and summer training. Gliding centres augment the air cadet proficiency level program by providing aviation training and gliding opportunities not available at a squadron. Opportunities exist at gliding centres for CIC officers to be employed as gliding centre coordinators, pilots, ground crew or instructional staff. The maximum number of paid days varies by region and position. Each gliding centre uses the same instructional staff to maintain continuity and to build a pool of experienced instructors familiar with the specific centre. During the summer months, the 5 regional centres operate as CSTCs and are responsible for delivering programs which may include Basic Aviation, Advanced Aviation, Glider Pilot Scholarship and Power Pilot Scholarship.

5. What positions are available at a cadet detachment for a CIC officer?

Positions at cadet detachments that CIC officers could fill include Area Cadet Officer (ACO), Detachment Movements Officer or Detachment Commander. Positions will vary by region and detachment.

6. List six NDAs.

Established NDAs include but are not limited to:

- the national cadet air rifle championship;
- the national cadet winter biathlon championship;
- sea, army and air cadet international exchange programs;
- sea cadet deployments on board Her Majesty's Canadian Ships (HMCS), Coast Guard Ships, etc.;
- the national sea cadet regatta;
- the sea cadet national tall ship deployment;
- the sea cadet seamanship concentration;
- the army cadet program domestic expedition;
- the army cadet program international expedition;
- the air cadet program Oshkosh Trip; and
- the air cadet program York Soaring Award.

THIS PAGE INTENTIONALLY LEFT BLANK



ROYAL CANADIAN AIR CADETS
PROFICIENCY LEVEL FIVE
INSTRUCTIONAL GUIDE



SECTION 3

**EO C507.02 – IDENTIFY VOLUNTEER OPPORTUNITIES
 WITH THE AIR CADET LEAGUE OF CANADA (ACLC)**

Total Time: 90 min

PREPARATION

PRE-LESSON INSTRUCTIONS

Resources needed for the delivery of this self-study package are listed in the lesson specification located in A-CR-CCP-805/PG-001, *Proficiency Level Five Qualification Standard and Plan*, Chapter 4. Specific uses for said resources are identified throughout the self-study guide within the section for which they are required.

Review the lesson content and become familiar with the material prior to facilitating this lesson.

Self-study packages are intended to be completed by the cadet independently. More information about self-study packages can be found in the foreword and preface.

No less than 14 days prior to the cadet attempting this self-study package, contact the ACLC Squadron Advisor to schedule a 30-minute meeting between an ACLC member and the Proficiency Level Five cadet.

Photocopy the self-study package located at Attachment A for the cadet.

Photocopy the answer key located at Attachment B but **do not** provide it to the cadet.

Photocopy the Speaker's Notes / Agenda located at Attachment C and provide it to the ACLC member prior to the meeting date.

PRE-LESSON ASSIGNMENT

Nil.

APPROACH

A self study was chosen for this lesson as it allows the cadet to examine in greater detail volunteer opportunities with the ACLC at their own learning pace. This encourages the cadet to become more self-reliant and independent by focusing on their own learning instead of learning directed by the instructor.

INTRODUCTION

REVIEW

Nil.

OBJECTIVES

By the end of this lesson the cadet shall have identified volunteer opportunities with the ACLC.

IMPORTANCE

It is important for cadets to identify volunteer opportunities with the ACLC to become aware of their potential for meaningful involvement with the CCO after their cadet service concludes.

SELF-STUDY PACKAGE INSTRUCTIONS

OBJECTIVE

The objective of this self-study package is to have the cadet identify volunteer opportunities with the ACLC.

RESOURCES

- Self-study package, and
- Pen / pencil.

ACTIVITY LAYOUT

Provide the cadet with a classroom or training area suitable to complete the self-study package.

ACTIVITY INSTRUCTIONS

1. Provide the cadet with a copy of the self-study package located at Attachment A and a pen / pencil.
2. Allow the cadet 60 minutes to complete Sections 1 and 2 of the self-study package.
3. Provide assistance as required to the cadet.
4. Have the cadet attend a 30-minute meeting with a member of the ACLC.
5. Collect the self-study package once the cadet has finished.
6. Correct the self-study package with the answer key located at Attachment B.
7. Provide feedback to the cadet and indicate whether or not they have completed the enabling objective (EO).
8. Return the completed self-study package to the cadet for their future reference.
9. Record the result in the cadet's logbook and Cadet Training Record.

SAFETY

Nil.

END OF LESSON CONFIRMATION

The cadet's completion of the self-study package will serve as the confirmation of this lesson.

CONCLUSION

HOMEWORK / READING / PRACTICE

Nil.

METHOD OF EVALUATION

Nil.

CLOSING STATEMENT

It is important for you to identify volunteer opportunities with the ACLC to become aware of your potential for meaningful involvement with the CCO after your cadet service concludes.

INSTRUCTOR NOTES / REMARKS

The 30-minute meeting between the ACLC member and the Proficiency Level Five cadet should be scheduled for the third period of the training session in which the cadet is attempting this self-study package.

REFERENCES

A0-040 2005-113124 Vice-Chief of the Defence Staff. (2005). *Memorandum of understanding between the DND and the leagues*. Ottawa, ON: Department of National Defence.

C3-355 Air Cadet League of Canada. (2009). *Policy and procedure manual*. Retrieved February 9, 2010, from <http://www.aircadetleague.com/common/documents/images/ppm/ppm2009-2008.pdf>

IDENTIFY VOLUNTEER OPPORTUNITIES WITH THE AIR CADET LEAGUE OF CANADA (ACLC)



SECTION 1: REVIEW THE RESPONSIBILITIES OF THE ACLC

SECTION 2: EXAMPLES OF SUPPORT PROVIDED BY THE ACLC TO AIR CADETS

SECTION 3: ATTEND A MEETING WITH A MEMBER OF THE ACLC

SECTION 1
REVIEW THE RESPONSIBILITIES OF ACLC

ROLE OF THE ACLC

A role of the ACLC is to provide training, support and an organizational framework to the Squadron Sponsoring Committee (SSC), which is the group at the local level that fulfills the ACLC's responsibilities in supporting a squadron. This is accomplished by a member of the ACLC called the Squadron Advisor. An SSC is comprised of a chairperson, a vice-chair, a secretary, a treasurer and chairs of committees who oversee various activities of the committee such as, fundraising, recruiting, transportation, food services, public relations and special projects. The SSC chairperson is the liaison between the ACLC and the CO.

It is the role of the ACLC to ensure their responsibilities are carried out in accordance with the Memorandum of Understanding, for the proper and efficient delivery of the Cadet Program within Canada.



Look online at <http://www.cadets.ca/WorkArea/linkit.aspx?LinkIdentifier=id&ItemID=53729> for more information on the Memorandum of Understanding.



The Air Cadet League of Canada can be abbreviated two ways: ACLC and ACL. The abbreviation ACL is used to avoid confusion within documents that also contain references to the Army Cadet League of Canada, which also uses the abbreviation ACLC.



Can you name your Squadron Advisor or any of the members of your SSC?

RESPONSIBILITIES OF THE ACLC / SSC

The following represent the responsibilities of the ACLC / SSC.

Fundraising

Prior to the start of each training year, the squadron creates a plan as to what type of training in which they wish to participate and the support that will be required. Through a series of meetings between the SSC chairperson and the CO, a list of support requirements is drafted that outlines what funds are immediately available and what funds need to be raised. It is the responsibility of the SSC to organize fundraising activities in consultation with the CO.



What fundraising activities has your SSC sponsored for your squadron?

Recruiting Cadets

The Cadet Program relies on a steady flow of new recruits every training year so that training can run smoothly. When recruitment is low, it creates a void of senior cadets in the future, causing instructor shortages. The SSC is responsible for organizing community campaigns to attract cadets to become members of the squadron.

	What kind of recruiting campaigns would you suggest for your community?
	<hr/>
	<hr/>

Recruiting Officers

It is the responsibility of the SSC to conduct local campaigns to attract potential candidates within the community to become members of the Cadet Instructors Cadre (CIC) and Civilian Instructors / Civilian Volunteers (CI / CV). This is based on the needs as confirmed by the CO of the squadron.

Screening Volunteers

The ACLC has a comprehensive screening program for volunteers that helps determine if a person is suitable to work with young people and in what capacity they could best serve. The ACLC has both a legal and moral obligation to provide an environment where the cadets can safely learn and grow.

The screening program features the following elements:

- a police records check,
- a Vulnerable Sector Screening (VSS),
- a local background check,
- a probationary period, including interviews and evaluations,
- a central repository for tracking volunteers working with cadets,
- photo identification for screened members,
- an identification verification system and safety guidelines for volunteer drivers,
- comprehensive harassment, abuse and cadet safety policies,
- the ability to share information with other youth organizations, and
- the requirement to be re-screened every five years.

To apply as a volunteer, an application form must be completed and a photograph supplied to produce a Volunteer Identification Card. The volunteer is briefed on the Harassment and Abuse Policy, the Drug and Alcohol Policy and the Cadet Safety Policy. Completed applications are processed by the Provincial / Territorial Office and stored in accordance with the Information Protection and Privacy Policy. As a final check, applications are sent to the National Office who checks if the volunteer has applied in other jurisdictions and if so, were any concerns raised. Once a volunteer is approved, they are sent their Volunteer Identification Card in the mail. Declined volunteers are notified by letter.

Providing Adequate Office and Training Facilities

The SSC is responsible for providing adequate office and training facilities, where they are not provided by DND. This includes providing insurance as necessary.

Participating in Selection Boards for Senior Cadet Rank Appointments

Prior to promoting a cadet to the rank of Warrant Officer Class 2 (WO2) or higher, the CO shall conduct a merit review board. It is the mandate of a merit review board to make recommendations to the CO regarding the cadets deserving senior rank promotions and to prioritize potential candidates if required. The ACLC / SSC provides a board member to participate in the merit review board. The final decision for any cadet rank promotion rests with the CO.

Participating in Selections for Air Cadet Summer Training / Exchanges

The SSC is responsible for cooperating with the squadron's CO to encourage cadets' participation in summer courses and exchanges. They also participate in the selection process, in accordance with the Memorandum of Understanding.



Did you know?

The ACLC conducts the provincial selection boards for scholarship courses and international exchanges.

Participating in Selections for Honours and Awards

The SSC is responsible for participating in the joint selection process for honours and awards from the league and in initiating the selection process for ACLC-specific awards.



Activate Your Brain #1:

What is the role of the ACLC / SSC?



Activate Your Brain #2:

Why must the ACLC screen all volunteers?



Activate Your Brain #3:

What does the ACLC / SSC member provide during a merit review board?



Activate Your Brain #4:

Who initiates the selection process for ACLC-specific awards and recognition?

SECTION 2

EXAMPLES OF SUPPORT PROVIDED BY THE ACLC TO AIR CADETS

NATIONAL EFFECTIVE SPEAKING COMPETITION (NES)

The NES for air cadets is an annual Competition. Competitions are held at the zone, provincial / territorial, and national levels. The final national phase of the Competition is held in conjunction with the Annual General Meeting of the ACLC.



Did you know?

WestJet, as an official sponsor of the NES, donates the flight to the competition for each provincial / territorial winner and one parent / escort.

YOUNG EAGLES PROGRAM

The Young Eagles Program was started by the Experimental Aircraft Association (EAA) to promote the discovery of flight among young people. Under the program, each young person who takes a familiarization flight receives a certificate and is registered as a Young Eagle in the World's Largest Logbook in the EAA Museum in Oshkosh, Wisconsin. The ACLC has joined in partnership with the EAA to involve those cadets participating in squadron glider familiarization flights in the Young Eagles Program.

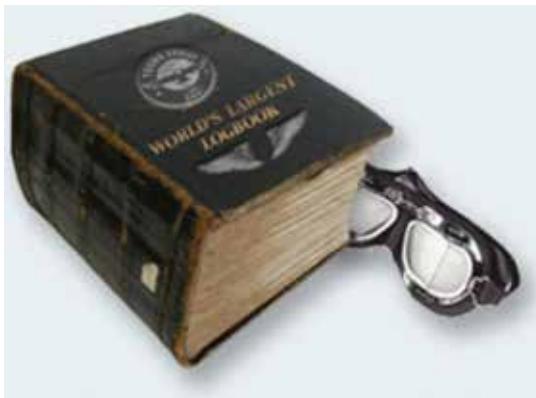

Figure A-1 World's Largest Logbook

Note. From "Young Eagles" by Experimental Aircraft Association, Inc., 2010, *World's Largest Logbook*. Copyright 2010 by Experimental Aircraft Association, Inc. Retrieved February 18, 2010 from <http://www.young eagles.org/logbook/>



Is your name in the World's Largest Logbook?

HONOURS AND AWARDS

The ACLC is proud to recognize the contributions that cadets make to their local communities. The following is an overview of the various national awards offered to members of the Air Cadet Program.

Cadet Award for Bravery. Awarded by the Canadian Forces to cadets who perform outstanding deeds of valour which involve risking their own lives in saving the lives or property of others. The award is in the form of a medal to be worn on the left breast of the uniform. The CO initiates the recommendation, which is forwarded through all three levels of the ACLC where the Executive Committee forwards it to Canadian Cadet Movement National Honours and Awards Committee. Final approval is made by the Chief of Defence Staff (CDS).



Figure A-2 Cadet Award for Bravery

Note. From "Wikimedia", 2010, *Cadet Award for Bravery*. Retrieved February 18, 2010, from http://en.wikipedia.org/wiki/File:Cadet_Medal_for_Bravery.jpg

ACLC Air Cadet Service Medal. This award recognizes continuous cadet service of at least four years by deserving cadets. The award is in the form of a medal to be worn on the right breast of the uniform.



Figure A-3 ACLC Air Cadet Service Medal

Note. From "Wikimedia", 2010, *Air Cadet Service Medal*. Retrieved February 18, 2010, from http://en.wikipedia.org/wiki/File:Royal_Canadian_Air_Cadet_Long_Service_Medal.jpg

Cadet Certificate of Commendation. This certificate is awarded by the Canadian Forces to cadets who perform outstanding gallantry in saving lives or property of others. It is a small silver pin worn on the right breast pocket of the jacket and the shirt. The CO initiates the recommendation which is forwarded through all three levels of the ACLC where the Executive Committee forwards it to Canadian Cadet Movement National Honours and Awards Committee. Final approval is made by the CDS.



Figure A-4 Cadet Certificate of Commendation

Note. Created by Director Cadets 3, 2010, Ottawa, ON: Department of National Defence.

Annual Music Awards for Excellence. These awards (ACLC gold watches) are presented annually to the top musician in each of the pipes and drums and military band categories.

Royal Canadian Legion Air Cadet of the Year Award. The Royal Canadian Legion (RCL) Air Cadet of the Year Award is selected annually by the ACLC on behalf of the RCL. At the invitation of the RCL, the RCL Air Cadet of the Year is invited by the RCL to act as the youth representative for the annual National Remembrance Day Ceremony held in Ottawa. The cadet is a member of the Vice-Regal Party (along with the RCL Army and Sea Cadet of the Year) for the National Remembrance Day Ceremonies. The cadet accompanies the Vice-Regal party during the ceremonies and assists with laying wreaths. The cadet also receives the Royal Canadian Legion Medal of Excellence, a \$500 bursary and participates in other ceremonies, events and visits while in Ottawa.

The Colonel Robert Perron Fitness Award. This award recognizes outstanding achievement in physical fitness and is presented annually to the cadet who attains the highest physical fitness test score. Sea, Army, and Air Cadets are eligible to apply for this Award.

Effective Speaking Competition Pins

Participants at each level are awarded a pin: bronze at the zone level, silver at the provincial / territorial level, and gold at the national level.



Figure A-7 Effective Speaking Competition Pins

Note. From "Air Cadet League of Canada", 2010, *Catalogue*. Retrieved February 18, 2010, from <http://www.aircadetleague.com/en/webstore/tryagain/trophy1.html>

Continuation Flying Awards and Power Familiarization Pilot Upgrade Scholarship

The Air Cadet League of Canada routinely pursues partnerships with various aviation and aerospace industry partners in Canada. These partners periodically provide monetary support through the Air Cadet League of Canada to cadets in the form of Continuation Flying Awards and Power Familiarization Pilot Upgrade Scholarships. Recent contributors include:

- Air Canada Pilots Association (ACPA);
- Airline Pilots Association (ALPA);
- Air Transport Association of Canada (ATAC);
- CAE;
- Canadian Business Aviation Association (CBAA); and
- WestJet Pilots Association (WJPA).

Airport Operations Awards

The following awards are presented to candidates of the Advanced Aviation Technology Course – Airport Operations.

Canadian Airports Council (CAC). Two awards of \$500 each are awarded to (1) the cadet who achieves the highest academic achievement and (2) the most improved cadet.

Aircraft Maintenance Awards

The following awards are presented to candidates of the Advanced Aviation Technology Course–Aircraft Maintenance.

Canadian Aviation Maintenance Council. A \$500 award to the cadet achieving the highest academic achievement on the course.

AVEOS Fleet Performance Inc. A \$500 award to the most improved cadet on the course.

TRUST AWARDS

In addition to the industry-specific awards listed above, there are also related ACLC partner / trust aviation awards.

Pilot Training Achievement Awards. Awarded annually to cadets who have graduated from the Power Pilot Scholarship National Summer Training course. An amount of money, dependent on the bursary, is either given to the recipient or credited to a flight training centre in to cover the initial expenses for continuing to fly at the local flying club or flight training centre. The exact value / number of these awards, as well as the specific trusts involved, may vary from year to year depending on the trust funds available. These awards include:

- Air Force Association of Canada Awards: Twenty-five \$300 awards,
- Commissionaire Frank Kobe Award: Twenty-four \$300 awards,
- Irvin Erb / Virginia Mitchell Award: Two \$1 000 awards (one each to the top male and the top female graduates),
- Sabre Pilots Association of the Air Division: Five \$500 awards,
- Soaring Association of Canada: Six \$300 awards,
- Terry Angus Memorial Award: One \$300 award,
- Virginia Mitchell Awards: \$300 awards,
- 99's Canadian Award in Aviation (female pilot): Three \$300 awards,
- 426 Thunderbird Squadron Association: \$300 award,
- BC Ex-Airforce POW Trust Fund: One \$300 award,
- Dodo Bird Club Trust Fund: Two \$300 awards,
- Bomber Harris Trust Fund: One \$300 award, and

Post-Secondary Scholarships

The following awards are open to all air cadets pursuing any field of study. The amount of the awards is determined annually, and it is dependent upon the earnings of the investment trusts donated by the Birchalls and Dales. The awards are normally in excess of \$1000.

Leonard and Kathleen Birchall Scholarship. Air Commodore Leonard Birchall and Mrs. Kathleen Birchall have been long-time supporters of the Air Cadet Program. This support has been shown in many ways, most recently through an annual scholarship to be offered through the ACLC. This scholarship is awarded on the basis of secondary school achievements combined with outstanding performance as an air cadet and a community member. This award may be received only once by an individual. Applicants must be graduates of a secondary school (or equivalent) system from any province or territory in the year of application, with the intent of immediately starting full-time, post-secondary education. Applicants must also prove that they have been accepted at a post-secondary education institution, which will lead to a degree, diploma, or professional or technical qualification. The application deadline is May 1 of the entrance year.



Did you know?

On April 4, 1942, Squadron Leader (equivalent to Major) Leonard Birchall was flying a Catalina flying boat patrolling over the Indian Ocean south of the island of Ceylon (now known as Sri Lanka). The crew spotted a large Japanese fleet heading for Ceylon which at the time was home for the Royal Navy's Eastern Fleet. The crew's radio message saved the fleet, but their flying boat was shot down, killing three. His actions earned him the title "Saviour of Ceylon".

Squadron Leader Birchall spent the rest of World War II as a prisoner of war (POW). Through his leadership, the Allied prisoner death rate at the camp where he spent over two years was less than 2% (average was 30%).

Air Commodore (equivalent to Brigadier General) Birchall, Commandant of Royal Military College, Kingston, Ontario, retired from the RCAF in 1967. He passed away on September 10, 2004 at the age of 89.



Figure A-9 Squadron Leader Birchall

Note. From "York University" (2004). *Y-file e-bulletin* (September 30, 2004). Retrieved March 10, 2010 www.yorku.ca/yfile/archive/index.asp?Article=3382



Figure A-10 Air Commodore Birchall

Note. From "York University" (2004). *Y-file e-bulletin* (September 30, 2004). Retrieved March 10, 2010 www.yorku.ca/yfile/archive/index.asp?Article=3382

Robert and Mary Dale Scholarship. Robert Dale served as National President of the ACLC from 1972–1973. Mr. Dale and his wife, Mary, set up an annual scholarship to be offered by the ACLC. This scholarship is awarded on the basis of secondary school achievements combined with outstanding performance as an air cadet. This award may be received only once by an individual. Applicants must be graduates of a secondary school (or equivalent) system from any province or territory in the year of application, with the intent of immediately

starting full-time, post-secondary education. Applicants must also prove that they have been accepted at a post-secondary education institution, which will lead to a degree, diploma, or a professional or technical qualification. The application deadline is May 1 of the entrance year.



Look online at <http://www.aircadetleague.com/en/infoforcadetsandsquadron/awards/> for more information on the application process for these scholarships.



Activate Your Brain #5:

What is the criteria for the awarding the ACLC Air Cadet Service Medal?



Activate Your Brain #6:

How is the Leonard and Kathleen Birchall Scholarship awarded?



Activate Your Brain #7:

What volunteer activities are available with the ACLC after concluding your service in the Cadet Program?



Activate Your Brain #8:

What elements does the screening process feature?



Congratulations, you have completed your self-study package on EO C507.02 (Identify Volunteer Opportunities with the Air Cadet League of Canada). Hand the completed package to the Training Officer / Proficiency Level Officer who will record your completion in your Proficiency Level Five logbook.

SELF-STUDY PACKAGE ANSWER KEY



Activate Your Brain #1:

What is the role of the ACLC / SSC?

To ensure responsibilities are carried out IAW the Memorandum of Understanding, for the proper and efficient delivery of the Cadet Program.



Activate Your Brain #2:

Why must the ACLC screen all volunteers?

The ACLC has both a legal and moral obligation to provide an environment where cadets can safely learn and grow.



Activate Your Brain #3:

What does the ACLC / SSC member provide during a merit review board?

Recommendations for the selection process to the CO.



Activate Your Brain #4:

Who initiates the selection process for ACLC-specific awards and recognition?

The ACLC / SSC.



Activate Your Brain #5:

What is the criteria for the awarding the ACLC Air Cadet Service Medal?

Be a deserving cadet with at least four years continuous cadet service.



Activate Your Brain #6:

How is the Leonard and Kathleen Birchall Scholarship awarded?

The scholarship is awarded on the basis of secondary school achievements combined with outstanding performance as an air cadet and a community member. This award may be received only once by an individual. Applicants must be graduates of a secondary school (or equivalent) system from any province or territory in the year of application, with the intent of immediately starting full-time, post-secondary education. Applicants must also prove that they have been accepted at a post-secondary education institution which will lead to a degree, diploma, or professional or technical qualification. The application deadline is May 1 of the entrance year.



Activate Your Brain #7:

What volunteer activities are available with the ACLC after concluding your service in the Cadet Program?

Volunteer activities include:

- enrolling as a member of the CIC;
- volunteering as a Civilian Instructor / Civilian Volunteer with the squadron;
- participating as an ACLC / SSC member;
- participating as a member of an SSC special teams (fundraising, Special Events Committee); and
- participating in any other ACLC / SSC-specific duties.



Activate Your Brain #8:

What elements does the screening process feature?

The screening process features:

- a police records check,
- a VSS,
- a local background check,
- a probationary period, including interviews and evaluations,
- a central repository for tracking volunteers working with cadets,
- photo identification for screened members,
- an identification verification system and safety guidelines for volunteer drivers,
- comprehensive harassment, abuse and cadet safety policies,
- the ability to share information with other youth organizations, and
- the requirement to be re-screened every five years.

THIS PAGE INTENTIONALLY LEFT BLANK

SPEAKER'S NOTES / AGENDA

Purpose

To provide a participatory experience for a Proficiency Level Five cadet on a one-on-one basis with a member of the ACLC to explain the role of the volunteer and the current needs and opportunities at the squadron.

Time

A maximum of 30 minutes will be allocated for the meeting.

Assumptions

Assumptions are outlined as follows:

1. Cadet participation will be voluntary and part of a fact-finding exercise included in Proficiency Level Five to broaden the cadet's awareness of options that become available when cadet service concludes.
2. The cadet is approaching a mandatory transition phase of their life regardless of whether or not continued involvement with the Cadet Program is to be part of it.
3. If there is to be continued involvement with the Cadet Program it will be in an adult role. Communication between the ACLC representative and the cadet will be conducted on an adult to adult basis to set an appropriate atmosphere and achieve the desired outcome of the meeting.

The Cadet Perspective

The desired outcome from the cadet's perspective should be:

1. To become aware of their potential for meaningful involvement with the CCO after their cadet service concludes.
2. To appreciate the range of volunteer activities available and the different amount of time commitment that may be required for each.
3. To understand the screening and registration process required of all adult volunteers in the cadet program.

The ACLC / SSC Perspective

The desired outcome from the ACLC perspective should be:

1. To describe and discuss with the cadet participant the options available at the squadron, the work involved with each, the competencies needed and the appropriate time required of the volunteer.
2. To illustrate the range and extent of involvement of volunteers at the squadron with sufficient detail to cover the main points of each position but tailored to what teams or positions are active or needed to enhance the ACLC / SSC operation.
3. Information on the mandatory screening and registration process.

Meeting Agenda

Discussion Points:

1. Compare the different but complementary roles of the CO's team and the ACLC / SSC. Emphasize the complementary roles of the CIC and ACLC / SSC.
2. Review the guiding principles of the ACLC. Emphasize that a successful year for an ACLC / SSC generates increased resources for the CO to work with and thereby greater benefits and opportunities for the cadets.
3. Encourage the cadet to share some of their experiences, to include:
 - a. summer training,
 - b. leadership and instructional skills acquired, and
 - c. school involvement where applicable.

Emphasize how these are of value to the ACLC / SSC.

4. Outline the varying degrees of involvement open to ACLC / SSC volunteers. The year-round involvement of the executive committee members can be compared to the monthly production of the squadron newsletter and to the intermittent activities other member teams.
5. Confirm with the cadet that they have the ability to select an area of involvement that is sufficiently flexible to meet their new routine after their cadet service ends.
6. Explore whether or not working with the ACLC / SSC for an interim period would be beneficial to them prior to joining the CO's team if that has already been agreed to by the CO.
7. Discuss the requirements and process for screening and registration and why this is given such a high priority.
8. Conclude the session with a discussion on what the participant sees as having been the biggest challenge and the greatest achievement so far as an air cadet.

Whether they stay involved or not, it is important the session concludes on a positive note with a projection for their future involvement with the Air Cadet Program. Whatever the future holds for them they will always be part of an exclusive alumni and their support and advocacy for the Air Cadet Program is the best advertisement possible.

Send an appropriate note to the CO confirming the completion of the meeting.



**COMMON TRAINING
PROFICIENCY LEVEL FIVE
INSTRUCTIONAL GUIDE**



SECTION 3

EO C507.03 – REFLECT UPON THE CADET EXPERIENCE

Total Time:

90 min

PREPARATION

PRE-LESSON INSTRUCTIONS

Resources needed for the completion of this self-study package are listed in the lesson specification located in A-CR-CCP-805/PG-001, *Proficiency Level Five Qualification Standard and Plan*, Chapter 4. Specific uses for said resources are identified throughout the self-study package within the section for which they are required.

Self-study packages are intended to be completed by the cadet independently. More information about self-study packages can be found in the foreword and preface.

Review the lesson content and become familiar with the material prior to facilitating this lesson.

Photocopy the self-study package located at Attachment A for the cadet.

PRE-LESSON ASSIGNMENT

Nil.

APPROACH

A self study was chosen for this lesson as it allows the cadet to reflect upon how their cadet experience can be used to make a successful transition to adulthood at their own learning pace. This encourages the cadet to become more self-reliant and independent by focusing on their own learning instead of learning directed by the instructor.

INTRODUCTION

REVIEW

Nil.

OBJECTIVES

By the end of this lesson the cadet shall have reflected upon the cadet experience.

IMPORTANCE

It is important for cadets to reflect upon the cadet experience because it enables them to pass on their experience and knowledge to the cadets they will be leading and instructing. By having cadets reflect on how the Cadet Program has influenced them, they apply lessons learned to future cadet experiences. Also, a reflection of the cadet experience helps to prepare the cadets as they transition out of adolescence by providing them an opportunity to develop an action plan that utilizes the transferable skills developed while participating in the Cadet Program.

SELF-STUDY PACKAGE INSTRUCTIONS

OBJECTIVE

The objective of this self-study package is to have the cadet reflect upon the cadet experience.

RESOURCES

- Self-study package, and
- Pen / pencil.

ACTIVITY LAYOUT

Provide the cadet with a classroom or training area suitable to complete the self-study package.

ACTIVITY INSTRUCTIONS

1. Provide the cadet with a copy of the self-study package located at Attachment A and a pen / pencil.
2. Allow the cadet 90 minutes to complete the self-study package.
3. Provide assistance as required to the cadet.
4. Collect the self-study package once the cadet has finished.
5. Provide feedback to the cadet and indicate whether or not they have completed the Enabling Objective (EO).
6. Return the completed self-study package to the cadet for their future reference.
7. Record the result in the cadet's logbook and Cadet Training Record.

SAFETY

Nil.

END OF LESSON CONFIRMATION

The cadet's completion of the self-study package will serve as the confirmation of this lesson.

CONCLUSION

HOMEWORK / READING / PRACTICE

Nil.

METHOD OF EVALUATION

Nil.

CLOSING STATEMENT

Reflecting upon the cadet experience enables you to pass on your experience and knowledge to the cadets you will be leading and instructing. Reflecting on how the Cadet Program has influenced you, enables you to apply lessons learned to future cadet experiences. Also, a reflection of the cadet experience helps to prepare you as you transition out of adolescence by providing you an opportunity to develop an action plan that utilizes the skills you have developed while participating in the Cadet Program.

INSTRUCTOR NOTES / REMARKS

Nil.

REFERENCES

C0-447 Furstenberg, F. F., Kennedy, S., McCloyd, V. C., Rumbaut, R. G., and Settersen, R. A. (2003). *Between adolescence and adulthood: Expectations about the timing of adulthood*. Retrieved October 28, 2009, from <http://www.transad.pop.upenn.edu/downloads/between.pdf>

C0-448 COMPAS Inc. (2002). *Cadet training focus group study*. Ottawa, ON: Department of National Defence.

C0-449 Arnett, J. J. (2004). *Emerging adulthood: The winding road from the late teens through the twenties (Chapter 1)*. Retrieved October 28, 2009, from <http://www.jeffreyarnett.com/EmerAdul.chap1.pdf>

C0-450 Whitehead, S. (2009). *Emerging adulthood*. Retrieved October 27, 2009, from http://www.Parenthood.com/article-topics/emerging_adulthood.html

C0-451 Grossman, L. (2009). *Grow up? Not so fast*. Retrieved October 28, 2009, from <http://www.time.com/time/magazine/article/0,9171,1018089,00.html>

REFLECT

UPON THE CADET EXPERIENCE

SECTION 1: REFLECT UPON THE CADET EXPERIENCE

SECTION 2: THE CADET EXPERIENCE AND ADULTHOOD

SECTION 3: DEVELOP AN ACTION PLAN

SECTION 1
REFLECT UPON THE CADET EXPERIENCE

Circle the number on the scale for each statement below which best describes you. For example, if you are more likely to act toward the statement on the left, then the circled number would be placed closer to the left.

Make your own decisions?	5	4	3	2	1	Let others make decisions for you?
Look for answers to problems?	5	4	3	2	1	Let problems defeat you?
Take risks?	5	4	3	2	1	Play it safe?
Control your moods and thoughts?	5	4	3	2	1	Let someone else's bad mood get you down?
Feel exhilarated when you work hard?	5	4	3	2	1	Feel as if you have not accomplished anything, when you work hard?
Accept responsibility?	5	4	3	2	1	Make excuses, find fault, lay blame?
Measure yourself against your own standards?	5	4	3	2	1	Measure yourself against other's standards?
Speak up, set limits and voice your thoughts honestly?	5	4	3	2	1	Swallow your opinions, thoughts, and wishes?
Stand up straight and look people in the eye?	5	4	3	2	1	Slouch, with downcast eyes, looking sideways at people?
Respond flexibly to changing circumstances?	5	4	3	2	1	Hold on to what you have always done and thought because it is easy and comfortable?
Feel self-confident and self-assured?	5	4	3	2	1	Feel shy, nervous and awkward?

The survey you just completed is very similar to a self-esteem survey completed in year one as part of EO M103.02 (Map Personal Goals for the Training Year). Now that you have several years of cadet training and several more years of life experience, do you think your answers have changed?



Did you think your answers shifted to the left or to the right? What factors do you think contributed to this shift?

The left side of the survey contains statements that would be made by someone who exhibits a high level of self-esteem. Self-esteem is defined as having a good opinion of one's own character and abilities. There are many factors which contribute to one's self-esteem. Thinking back on the cadet experience you have had, do you think that the Cadet Program has contributed to any changes in your self-esteem?



What factors has the Cadet Program contributed to change your self-esteem?

THE CADET EXPERIENCE

The aim of the Cadet Program can be broken down into three parts:

- develop in youth the attributes of good citizenship and leadership;
- promote physical fitness; and
- stimulate the interest of youth in the sea, land, and air activities of the Canadian Forces.

These three aspects of the aim of the Cadet Program have been used a lot to validate the function of the youth program but what do they really mean? Examine the parts of the aim in further detail.

Citizenship. According to CATO 11-03, *Cadet Program Mandate*, citizenship can be defined as when cadets develop an understanding of and appreciation for community membership and involvement within cadet, local, regional, provincial, national and global communities. Inherent in this membership is an acceptance of, and respect for, multiculturalism within Canada and the world. Through their active involvement, cadets will have a positive impact on local communities, contributing to the community strength and vibrancy.



How has the Cadet Program helped you to meet the aim of citizenship? Brainstorm a list of activities in which you have taken part as part of the Cadet Program to meet this aim.

<hr/>	<hr/>
<hr/>	<hr/>
<hr/>	<hr/>

Leadership. According to CATO 11-03, *Cadet Program Mandate*, in the peer-led Cadet Program, cadets develop interpersonal skills and assume responsibility as effective team members, leaders and dynamic coaches that conduct themselves in an ethical and socially responsible way.



How has the Cadet Program helped you to meet the aim of leadership? Brainstorm a list of activities that you have taken part in as part of the Cadet Program to meet this aim.

<hr/>	<hr/>
<hr/>	<hr/>
<hr/>	<hr/>

Physical fitness. According to CATO 11-03, *Cadet Program Mandate*, the Cadet Program aims to promote physical well-being. Cadets develop an understanding of the benefits of fitness and a healthy lifestyle. This understanding combined with on-going participation in fitness activities, aids in the development of positive attitudes and behaviors that build resiliency within cadets and enable them to meet challenges.

	How has the Cadet Program helped you to meet the aim of physical fitness? Brainstorm a list of activities that you have taken part in as part of the Cadet Program to meet this aim.	
	_____	_____
	_____	_____
	_____	_____

Stimulate the interest of youth in the sea, land and air activities of the Canadian Forces. According to CATO 11-03, *Cadet Program Mandate*, by exposing youth to the sea, land, and air activities of the Canadian Forces they develop elemental skills through introduction to, and interaction with, their respective CF communities. To maximize the elemental experience, the Cadet Program educates and promotes liaison with civilian maritime, adventure and aviation communities. These combined experiences and interactions are essential to the unique identity of Sea, Army and Air Cadet Organizations, distinguishing each from the other, and the Cadet Program as a whole from other youth development programs.

	How has the Cadet Program helped you to meet the aim of stimulating the interest of youth in the sea, land and air activities of the Canadian Forces? Brainstorm a list of activities in which you have taken part as part of the Cadet Program to meet this aim.	
	_____	_____
	_____	_____
	_____	_____

By the end of your participation in the Cadet Program, it is expected that you will have met five participant outcomes. These outcomes are meant to be measurable and are defined within CATO 11-03, *Cadet Program Mandate*.

Emotional and physical well-being. The cadet will:

- optimize the functioning of the body through attitudes and behaviours; and
- understand that physical wellness is not a state of perfection, but rather, a lifelong process of healthy mind and body development.

Social competence. The manner in which a cadet:

- consistently responds to other individuals;
- expects other individuals to respond; and
- interacts with members of groups.

Cognitive competence. The cadet will exhibit intellectual development and integrate information into operational functions.

Proactive citizenship. The cadet will positively impact on and build strong communities.

Understanding the Canadian Forces. The cadet will:

- gain an understanding of the Canadian Forces through:
 - an introduction of the sea, land, or air elements of the Canadian Forces, and
 - an exposure to the sea, land, or air elements of the Canadian Forces; and
- develop a unique identity in each of the cadet organizations.

To demonstrate that a cadet has achieved an outcome of the Cadet Program, underlying competencies were developed. The competencies were specific tasks that a cadet should be able to perform that demonstrated an acceptable level of achievement in the outcome. The 14 competencies of the Cadet Program are detailed in CATO 11-03, *Cadet Program Mandate*.



Competency. An area in which a person is adequately qualified or capable.

The following chart details the 14 competencies of the Cadet Program. Using the scale provided, rate yourself on your ability to complete each task. The higher the number, the more capable you believe you are at completing the task. There are no right or wrong answers but try to be as honest as possible during your self-assessment.

Participant Outcome	Competency	Scale				
Emotional and Physical Well-Being	Display positive self-esteem and personal qualities.	1	2	3	4	5
	Meet physical challenges by living a healthy and active lifestyle.	1	2	3	4	5
Social Competence	Contribute as an effective team member.	1	2	3	4	5
	Accept personal accountability for actions and choices.	1	2	3	4	5
	Exercise sound judgment.	1	2	3	4	5
	Demonstrate effective interpersonal communication skills.	1	2	3	4	5
Cognitive Competence	Solve problems.	1	2	3	4	5
	Think creatively and critically.	1	2	3	4	5
	Display a positive attitude toward learning.	1	2	3	4	5
Proactive Citizenship	Exemplify positive values.	1	2	3	4	5
	Participate actively as a valued member of a community.	1	2	3	4	5
	Commitment to community.	1	2	3	4	5

Participant Outcome	Competency	Scale				
Understanding the Canadian Forces	Knowledge of the history of the Canadian Forces.	1	2	3	4	5
	Knowledge of the Canadian Forces' contributions as a national institution.	1	2	3	4	5



Of the 14 competencies listed, what do you feel are the most important ones for cadets?
 Make a list of your top five competencies.

1. _____
2. _____
3. _____
4. _____
5. _____

Although the Cadet Program has created a specific list of competencies, there are many other competencies that a cadet develops while in the program. These competencies are the hands-on skills and leadership skills that a cadet develops while in the program.



Did You Know?

Hands-on skills are sometimes referred to as hard skills. This is because they usually result in a project or a measurable effect. Hard skills include things like sailing a boat, lighting a stove, or piloting a glider.

Leadership skills are sometimes referred to as soft skills. This is because they result in things which are harder to define. Soft skills include things like communication, teamwork or the ability to adapt.

Skills Chart		
Critical thinking	Leadership	Mentoring
Delegating responsibility	Decision making	Organizing
Being flexible	Professionalism	Reading
Setting goals	Writing music harmony	Gliding
Time management	Biathlon	Sewing
Managing groups	Reporting information	Meteorology
Planning	Posture	Fibreglassing
Anatomy	Respect	Patience
Being responsible	Map and compass	Punctual
Caring	Identifying problems	Prioritizing
Fieldcraft	Motivating others	Self control
Scheduling	Identifying resources	Applying logic
First aid	Iron	Nutrition
Navigation	Cycling	Filing
Public speaking	Use of the chain of command	Understanding music theory
Being service orientated	Teambuilding	Listening attentively
Networking	Situational management	Efficient
Being creative	Dedicated	Consistent
Small craft operations	Coaching	Radio procedure
Taking initiative	Tuning boats	Harassment awareness
Understanding air law	Expressing ideas	Multi-tasking
Conducting an ensemble	Using firefighting equipment	Providing appropriate feedback

SECTION 2 THE CADET EXPERIENCE AND ADULTHOOD

What does it mean to be an adult? The answer is not as easy as you might think. The definition of what it means to be an adult has changed over the last 20 years. The criteria that your parents or grandparents used to establish adulthood is a lot different than the criteria you face as you enter adulthood.

THE FACTORS OF ADULTHOOD

What are the factors to consider when classifying someone as being an adult?

- Completed education?
- Leaving parents' home?
- Being financially independent?
- Being married?
- Having children?
- Having a career?

The importance of each of these factors, and how they are met by youth in the transition of adulthood, has changed dramatically over the last few decades. A comparison can be made of each factor's affect on adulthood—then and now.

Completed Education

Then. Education was usually completed with high school. It was during employment that training was given to the employee to help them advance in their career. It was usually only individuals from high income or privileged families who would attend university or college. In addition, it was only professionals (eg, doctors, lawyers, etc) who were required to gain degrees for employment. Most individuals completed their education at the age of 17 or 18.

Now. Today, more than half of the population attends college or university. Many employers expect potential employees to be well prepared for employment before they are hired. The demand for higher education has increased from only the privileged, to include middle and low income individuals. Individuals are also taking longer to complete their education. Although most universities offer four-year degree programs, many individuals are taking five or more years to complete them. Often times the extension of further education is to accommodate part-time studies so that students can work as they study. This means most individuals now complete their education in their mid-twenties.

Leaving the Parents' Home

Then. In most cases, individuals left home when they got married. Marriage happened at a much earlier age then it does now, so most individuals were only living with their parents one or two years after completing school. Males may have left the home sooner but females would normally have only moved out to move in with their husbands.

Now. Leaving the parents' home takes two different branches in current times. The first branch involves the majority of individuals. These individuals move out of their parents' home as soon as possible. Often they have multiple roommates and move many times. Often times they do not establish a more permanent living situation until after they have completed their education, established a career, or established a family (either with or without marriage). These individuals also have a high likelihood of moving back in with their parents at some point.

The second branch involves the minority of individuals. These individuals stay at home with their parents far longer. Often times they do not move out on their own until after they have completed their education, established a career, or established a family (either with or without marriage). These individuals may live at home with their parents until their late twenties.

Being Married

Then. Marriages occurred earlier in life; often women would be married by the age of 20 and men by the age of 23. Marriage was a big stepping stone on the road to adulthood. Individuals were encouraged to marry so that they could start raising families, or even later, depending on cultural norms.

Now. Marriage is often one of the last steps taken in the progression into adulthood. Many individuals are waiting until they have completed their education or established a career before getting married. For many, the idea of marriage is not considered until they are in their late-twenties or early-thirties. Added to this is the idea that marriage is not seen as mandatory as it once was. It is becoming increasingly normal for individuals live and raise a family together without being married.



Did You Know?

The concept of marriage has different outcomes depending on socio-economic class, geography, or even cultural differences.

Individuals who come from lower socio-economic backgrounds are more likely to marry at a younger age. Also, the average age of marriage varies from country to country. The following chart details the median marriage age of females in selected countries.

Industrial Countries	Age	Developing Countries	Age
United States	25	Nigeria	17
Australia	26	Egypt	19
Canada	26	Ghana	19
France	26	Indonesia	19
Germany	26	India	20
Italy	26	Morocco	20
Japan	27	Brazil	21

Figure A-1 Median Marriage Age of Females in Selected Countries

Note. From *Emerging Adulthood*. Retrieved October 27, 2009, from http://www.Parenthood.com/article-topics/emerging_adulthood.html



Which of the countries listed have the highest and lowest median age for marriage? Why do you think this is the case?

Having Children

Then. After marriage, having children was the next major stepping stone in becoming an adult. In many cases, newly-married couples had a child within one year of being married. The role of the woman was more home-based; fewer women had careers outside of the home. This often made it possible for couples to have larger families. The age for couples to have children was usually between the early-twenties and the mid-twenties.

Now. Having children has dropped from the forefront of adulthood. Again, most individuals are more concerned with completing their education and establishing a career before they have a family. Because many couples are dual working families, it is often more difficult for them to support families. As a result, families are having fewer children than they have had in the past. The age for couples to have children has risen to the late-twenties and the early-thirties.

Being Financially Independent

Then. When an individual moved out of their parent's home, they were expected to be financially independent. Support from parents was usually only expected for adult-establishing events, such as weddings and birth of children. Often times, sacrifices were made (eg, housing, vehicles, etc) so that an individual could live within their means. Most individuals did not start off their adult life with large debt loads.

Now. Parents are often expected to support their children well into their transition into adulthood; individuals remain living at home longer and / or need help paying for additional education and / or getting established on their own (eg, housing, vehicles). Even if an individual moves out of their parents' home, they are more likely to return at some point because they are unable to establish their own household. When parents are unable to financially support their children, the children are often forced to acquire large debts in order to pay for further education or to get established on their own. Individuals are often not able to become financially independent until after they have completed further education; as a result, the milestone of being financially independent is currently one of the top indications of adulthood.

Having a Career

Then. Individuals often entered a career path earlier in life. Often times, an individual would spend twenty or thirty years in the same career (often at the same company). Employers often trained an individual and provided them with avenues of progression. The career was the means to support the family; the concept of a career being enjoyable was not often a major consideration.

Now. There is far more time spent in preparing for a career. That being said, a career has become more than a means to support a family; many individuals look to enjoy their career. In fact, many individuals tie their self-identity very closely to their livelihood. As a result of this, many individuals change jobs within their career field many times. The idea of having a successful career is very important and often other aspects of being an adult are put on hold to establish a successful career.

During a General Social Survey, conducted in March 2002, participants were asked how important they felt each of the factors of adulthood was. The percentage of respondents who answered that the factor of adulthood was somewhat important, or higher, is charted below.

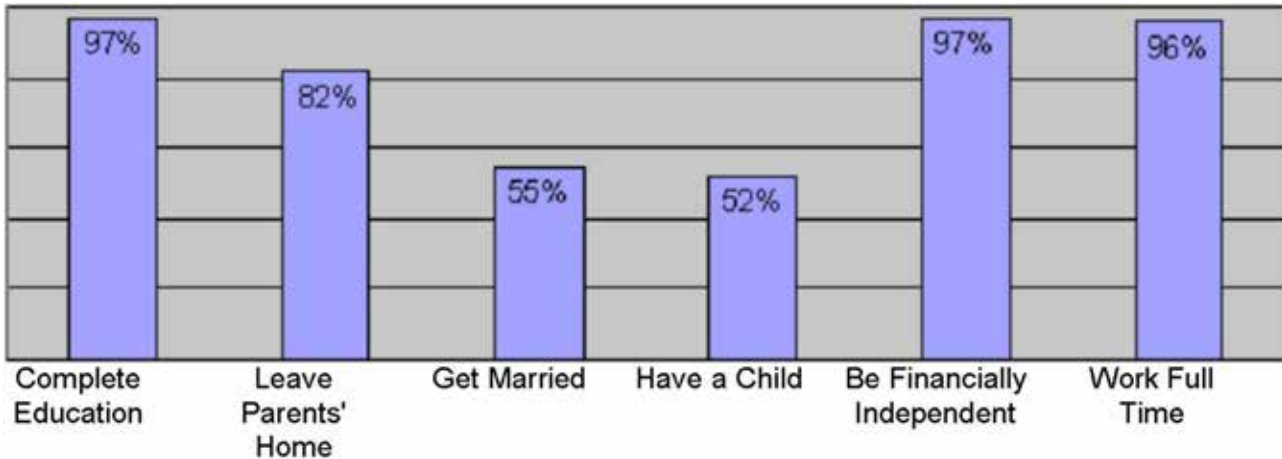



Figure A-2 Percentage Who Feel Event Important for Adulthood

Note. From *Between Adolescence and Adulthood: Expectations About the Timing of Adulthood*. Retrieved October 28, 2009, from <http://www.transad.pop.upenn.edu/downloads/between.pdf>

As you can see, completing an education, working full time, and being financially independent were rated as the most critical factors of adulthood; each of these relates directly to having a career. For youth today, the idea of having a career is one of the most important factors of adulthood.



In your opinion, are the most important factors of adulthood discussed? List the factors of adulthood in order of importance to you.

1. _____
2. _____
3. _____
4. _____
5. _____
6. _____



Are there any other factors of adulthood which you think are important?

PREPARING FOR ADULTHOOD



CATO 11-03, *Cadet Program Mandate*, states:

"The mission of the Cadet Program is to contribute to the development and preparation of youth for the transition to adulthood, enabling them to meet the challenges of modern society, through a dynamic, community-based program."

It is the mission of the Cadet Program to prepare youth for the transition to adulthood. It has been already detailed that the transition to adulthood is more complicated today than it has been in the past. A fundamental way that the Cadet Program prepares youth for the transition to adulthood is through the skills that youth develop while participating in the program.

Skills can be catalogued into two categories: transferable skills and non-transferable skills.

Transferable skills. These skills can be applied to many areas of adult life. These skills are also highly marketable to employers.



Did You Know?

Sometimes it is necessary to further catalogue transferable skills. Some possible categories of transferable skills are:

Communication. These are the skills of expression, transmission of knowledge, interpretation of knowledge, and the conveying of ideas.

Research and planning. These are the skills of searching for specific knowledge and the ability to conceptualize future needs and solutions for meeting those needs.

Human relations. These are the interpersonal skills for resolving conflict, relating to and helping people.

Organization, management, and leadership. These are the skills to supervise, direct and guide individuals and groups in the completion of tasks and fulfillment of goals.

Work survival. These are day-to-day skills that assist in promoting effective production and work satisfaction.

Non-transferable skills. These are often task-specific skills and as a result, do not often transfer from one aspect of adult life to another.



Non-transferable skills may still be highly employable skills. For example, trade skills are non-transferable skills (eg, woodworking, welding, plumbing). These skills are often in high demand.

Refer back to the list of skills you created in the previous section of the self-study package. Catalogue the list of skills you created into transferable and non-transferable skill lists.



Can you think of any skills you may have learned outside of the Cadet Program? Add them to the list above, cataloguing them as transferable and non-transferable skills.

Transferable Skills	Non-Transferable Skills

SECTION 3 DEVELOP AN ACTION PLAN

Adulthood has become harder to define. The path to adulthood is much longer than it used to be. Those in transition to adulthood, often take many different paths to reach the end goal. Sometimes, an individual takes multiple paths, starting fresh each time. For many, the transition to adulthood is a phase of self-exploration; more emphasis is placed on determining who they are before they solidify any path to adulthood.

It is important to take time to try and develop an action plan for the future. An action plan has several important aspects:

- an end goal;
- criteria to meet that goal;
- a set of actions to meet the criteria; and
- what skills you possess that will assist you in accomplishing the action.

End goal. The end goal is what you want to achieve. This could relate to a career, education, family, etc. The end goal should be realistic and achievable. For example, in 10 years you might be able to become a doctor but it is unlikely that you will be able to be Prime Minister that soon.

Criteria to meet that goal. The criteria to meet the goal could be a mixture of items. Perhaps the end goal has educational requirements or perhaps it has financial requirements. Some of the criteria will be large in scale and some will be small in scale (eg, graduate university versus getting your driver's license.)

A set of actions to meet the criteria. The actions required to meet the criteria. For example, if one of your criteria was to graduate post-secondary, a set of actions that may be required are:

1. graduate high school,
2. apply and get accepted to post-secondary education,
3. register for classes,
4. apply for and receive financial aid,
5. find a part-time job, and
6. study and do well in school.

The skills you possess that will assist you in accomplishing the action. What transferable and non-transferable skills you already have to help you reach your goal.

An action plan helps to give guidance as you transition into adulthood. That being said, it is very likely that the goals you set in this activity plan will change as you move toward adulthood. As you mature into adulthood and have increased opportunities to explore your interests, your goals may shift or become irrelevant.

Complete the action plan provided. Use this as a tool to help you prepare for your transition into adulthood.

ACTION PLAN	
NAME:	DATE:
RANK:	POSITION:
A. Brainstorm a list of possible goals for your future:	
From your brainstorm list, select three goals and list them in priority to you.	
1. _____ _____ _____	
2. _____ _____ _____	
3. _____ _____ _____	

ACTION PLAN		
B. Brainstorm a list of criteria needed to meet each goal.		
Goal Number One	Goal Number Two	Goal Number Three
C. Create a set of actions needed in order to meet the criteria.		
Goal Number One	Goal Number Two	Goal Number Three

ACTION PLAN		
D. Using your list of transferable and non-transferable skills from the previous section, list the skills that you already have that will help to reach your goal.		
Goal Number One	Goal Number Two	Goal Number Three

CONCLUSION

Reflecting on the cadet experience enables you to pass on your experience and knowledge to the cadets you will be leading and instructing. Reflect on how the Cadet Program has influenced you, enables you to apply lessons learned to future cadet experiences. Also, a reflection of the cadet experience helps to prepare you as you transition out of adolescence by providing you an opportunity to develop an action plan that uses the skills the Cadet Program has given them.



Congratulations, you have completed your self-study package on reflection on the cadet experience. Complete the action plan and then hand the completed package to the Proficiency Level Officer who will record your completion in your Proficiency Level Five logbook.

THIS PAGE INTENTIONALLY LEFT BLANK



**COMMON TRAINING
PROFICIENCY LEVEL FIVE
INSTRUCTIONAL GUIDE**



SECTION 1

EO C509.01 – MONITOR INSTRUCTION

Total Time:	90 min
-------------	--------

PREPARATION

PRE-LESSON INSTRUCTIONS

Resources needed for the delivery of this lesson are listed in the lesson specification located in A-CR-CCP-805/PG-001, *Proficiency Level Five Qualification Standard and Plan*, Chapter 4. Specific uses for said resources are identified throughout the self-study package within the section for which they are required.

Self-study packages are intended to be completed by the cadet independently. More information about self-study packages can be found in the forward and preface.

Review the lesson content and become familiar with the material prior to facilitating the lesson.

Photocopy the self-study package located at Attachment A, Assessment Form located at Attachment C and the Assessment Rubric located at Attachment D for the cadet.

Photocopy the answer key located at Attachment B but **do not** provide it to the cadet.

PRE-LESSON ASSIGNMENT

Nil.

APPROACH

A self study was chosen for this lesson as it allows the cadet to develop skills to monitor instruction at their own learning pace. This encourages the cadet to become more self-reliant and independent by focusing on their own learning instead of learning directed by the instructor.

INTRODUCTION

REVIEW

Nil.

OBJECTIVES

By the end of this lesson the cadet shall have monitored a lesson.

IMPORTANCE

It is important for cadets to monitor instruction as it is the best way to improve the abilities of instructors by providing them with effective and valuable feedback on their instructional capabilities.

SELF-STUDY PACKAGE INSTRUCTIONS

OBJECTIVE

The objective of this self-study package is to have the cadets monitor instruction.

RESOURCES

- Self-study package located at Attachment A,
- Assessment Checklist located at Attachment C,
- Assessment Rubric located at Attachment D, and
- Pen / pencil.

ACTIVITY LAYOUT

Provide the cadets with a classroom or training area suitable to complete the self-study package.

ACTIVITY INSTRUCTIONS

1. Provide the cadet with a copy of the self-study package, Assessment Checklist, Assessment Rubric and a pen / pencil.
2. Allow the cadet 60 minutes to complete the self-study package.
3. Provide assistance as required to the cadet.
4. Have the cadet monitor a period of instruction using the Assessment Checklist and Assessment Rubric.



It is preferred that the cadet monitor a period of instruction given by a peer (a cadet in the process of completing or who has completed Proficiency Level Five) or a subordinate cadet (a cadet completing Proficiency Level Four). If a period of instruction delivered by a peer or subordinate cadet is not available, a period of instruction delivered by an officer may be used providing the officer agrees to act as a training aid for the cadet.



While the cadet monitors a period of instruction, an experienced assessor must be paired with them. The experienced assessor should take notes on the period of instruction in order to provide a comparison for the cadet's evaluation. The experienced assessor will also participate in a role-play with the cadet so the cadet can practice debriefing a period of instruction.

5. After the lesson is complete, have the cadet debrief the period of instruction in a role-play scenario where the instructor is replaced by the experienced assessor.
6. Collect the self-study package once the cadet has finished.
7. Correct the self-study package with the self-study package answer key located at Attachment B.
8. Provide feedback to the cadet and indicate whether or not they have completed the enabling objective (EO).
9. Return the completed self-study package to the cadet for their future reference.
10. Record the result in the cadet's logbook and Cadet Training Record.

SAFETY

Nil.

END OF LESSON CONFIRMATION

The cadet's completion of the self-study package will serve as the confirmation of this lesson.

CONCLUSION

HOMEWORK / READING / PRACTICE

Nil

METHOD OF EVALUATION

Nil.

CLOSING STATEMENT

It is important for you to monitor instruction as it is the best way to improve the abilities of your instructors by providing them with effective and valuable feedback on their instructional capabilities.

INSTRUCTOR NOTES / REMARKS

Nil.

REFERENCES

A0-056 A-CR-CCP-913/PT-001 Cadet Instructors List Training School. (1978). *Technique of instruction*. Ottawa, ON: Department of National Defence.

A0-191 A-CR-CCP-914/PT-001 Cadet Instructors List Training School. (1978). *CIC instructional supervision*. Ottawa, ON: Department of National Defence.

A0-192 A-P9-000-009/PT-000 Canadian Forces Individual Training and Educational System. (2002). *Volume 9 instructional technique*. Ottawa, ON: Department of National Defence.

A0-193 A-P9-000-010/PT-000 Canadian Forces Individual Training and Educational System. (2002). *Volume 10 instructor supervision*. Ottawa, ON: Department of National Defence.

A0-194 A-P9-050-009/PT-006 Canadian Forces Individual Training and Educational System. (2002). *Volume 6 manual of individual training and education*. Ottawa, ON: Department of National Defence.

THIS PAGE INTENTIONALLY LEFT BLANK

MONITOR

INSTRUCTION



SECTION 1: THE PURPOSE OF MONITORING INSTRUCTION

SECTION 2: THE PROCESS OF MONITORING INSTRUCTION

SECTION 3: MONITOR INSTRUCTION

SECTION 1 THE PURPOSE OF MONITORING INSTRUCTION

THE IMPORTANCE OF MONITORING INSTRUCTION



"By providing direction, encouragement, advice and guidance, the supervisor strives to ensure that both instructors and course members are performing to the best of their ability. Fulfillment of this supervisory role contributes to effective training and the attainment of course objectives."

Canadian Forces Manual of Individual Training

An assessor is important for the development of instructors because they provide direction, encouragement and advice for improvement while ensuring the instructors know they are working toward a common goal. To do this, assessors must be aware of the material being instructed, and the latest methods of instruction.

The assessor's job is important because:

- even good instructors can deteriorate through neglect,
- some technically qualified instructors are not adequately taught how to instruct, and
- most instructors have some weaknesses and may not be aware of them.



When monitoring instruction in the Cadet Program, the instruction monitor is referred to as the assessor.

The overall aim of monitoring instruction is to improve instruction and learning. This is done by:

Promoting Learning Within the Training Environment

All training staff are collectively responsible to ensure that the training environment promotes learning. Areas such as instructor performance, learner achievement, support and administration are monitored to ensure the training goals are met in an effective and efficient manner. An assessor plays a key role in ensuring that learning takes place by monitoring the delivery of instruction.

Assessing Whether Learning is Taking Place

An assessor assesses whether learning is taking place on an ongoing basis by monitoring instruction. Monitoring instruction enables training staff to:

- ensure the content and emphasis of the material is in accordance with the intent of the Qualification Standard and Plan (QSP); and
- confirm the adequacy and appropriate use of instructional materials and training aids as directed in the QSP and Instructional Guide (IG) as required.

Providing Opportunities for Instructors to Improve Their Instructional Technique

Monitoring instruction improves both instruction and learning. Instructors should be provided with opportunities to improve their instructional technique. Assessors are responsible for identifying areas for development in instructional staff.

To develop instructional staff, assessors must monitor the instructional staff in the classroom or other training areas to provide feedback, recognize and reinforce effective performance and identify and correct any problems before they become serious and jeopardize learning.

The development of instructional skills can take place only when the instructional staff have the opportunity to instruct under supervision and receive feedback on their performance. Monitoring and feedback must focus on instructional staff development and improvement and be based on mutual respect between the instructional staff and the assessor.

A monitoring and feedback program based on mutual respect can be fostered when:

- the instructional staff and assessor agree on the specific skills and practices that characterize effective instruction;
- the assessor frequently monitors lessons to verify that the instructional staff use the skills / practices and meets to discuss them afterwards (feedback);
- the instructional staff and the assessor agree on areas for improvement; and
- the instructional staff and the assessor develop a specific plan for improvement together.

	Activate Your Brain #1:
	The aim of monitoring instruction is to improve instruction and learning. How is this done?
	<hr/> <hr/> <hr/> <hr/>

TYPES OF MONITORING

There are three types of monitoring commonly used to assess instruction. They are:

Formal Monitoring

Formal monitoring is specific and exact in nature. The assessor spends a considerable period of time observing the instructional practices of an instructor. This is the most important kind of assessment because it offers detection of specific strong and weak points in the instruction. This type of monitoring is where the assessor can make the biggest impact on an instructor's development. This type of monitoring should be done at least once for every instructor and more frequently for new or weak instructors.

Informal Monitoring

Informal monitoring is a shorter process than formal monitoring. It is the method by which an assessor ensures the general teaching procedures and managerial aspects of an instructor's classroom and training activities. This type of monitoring is useful for checking the progress of individuals who have already received a formal evaluation and determining if further formal evaluation is required.

Spot Checks

Spot checks are an even shorter process than informal monitoring. This type of assessment gives the assessor a general overview of the teaching situation. It allows them to verify the methods of instruction being employed and that the principles of instruction are being applied. Spot checks apprise the assessor of the general situation

and indicate to the instructor that they are interested in their work. The corrective measures taken from spot checks will probably be limited to cases where poor instructional situations are repeatedly evident. However, this type of monitoring is useful for keeping instructors on their toes, as they will never know when the assessor may be around to conduct a spot check.



Activate Your Brain #2:

What are the three types of monitoring?

1. _____
2. _____
3. _____

ASSESSMENT

An assessor assesses an instructor using various forms of assessment. Each form of assessment has advantages and disadvantages which give them a better fit for certain types of evaluation. The three main types of assessment used are assessment by scale, assessment by rating, and assessment by rubric.

Assessment by Scale

An assessment by scale uses a series of numbers to represent a level of achievement. This form of assessment is quick to use but does not adequately define what each number means. It is common for higher numbers to represent more proficiency; lower numbers represent less proficiency.

Criteria	Rating				
Tie a Figure 8 knot.	1	2	3	4	5

Figure 1 Example of Assessment by Scale

Note. Created by Director Cadets 3, 2010, Ottawa, ON: Department of National Defence.

Assessment by Rating

An assessment by rating uses a series of words to represent a level of achievement. This form of assessment is almost as quick to use as assessment by scale, but it defines the level of achievement more clearly. This form of assessment is used often in the Cadet Program.

Criteria	Rating			
Adopt the prone position.	Incomplete	Completed With Difficulty	Completed Without Difficulty	Exceeded the Standard

Figure 2 Example of Assessment by Rating

Note. Created by Director Cadets 3, 2010, Ottawa, ON: Department of National Defence.

Assessment by Rubric

An assessment rubric is the final form of commonly used assessment. It uses a set of word pictures to represent a level of achievement. Rubrics are specific to a task and describe levels of performance for individual criteria needed to complete that task. This gives an assessor a clearer understanding of what is required to attain a specific score. This form of assessment takes longer than scales or ratings, but clearly defines levels of achievement and breaks down a performance into smaller, more assessable, pieces.

	Incomplete (I)	Completed With Difficulty (D)	Completed Without Difficulty (C)	Exceeded Standard (E)
Lesson Preparation				
Lesson plan	The lesson plan was not submitted. It had insufficient detail to deliver a full period of instruction or it was not developed IAW the QSP.	The lesson plan was disorganized / hard to follow or was incomplete or included few details of how TPs are to be presented.	The lesson plan was neat and easy to follow. The introduction, body, end of lesson confirmation and conclusion were complete and accurate.	The lesson plan was neat and easy to follow. The introduction, body, end of lesson confirmation and conclusion were complete, accurate and detailed enough for another instructor to follow and implement without difficulty.

Figure 3 Example of Assessment by Rubric

Note. Created by Director Cadets 3, 2010, Ottawa, ON: Department of National Defence.



The above example of assessment of rubric only uses one criterion. This is not typical when using a rubric; more often, the rubric has a series of criteria, each one using a separate row to define performance.



Activate Your Brain #3:

What are the three types of assessment?

1. _____
2. _____
3. _____



Activate Your Brain #4:

Why would assessment by rating be chosen over assessment by rubric?

Assessment Difficulties

It is rare for two assessors to have the same result when assessing a performance (eg, one assessor might describe the performance as excellent and the other describes the performance as good). This difference in assessment can be related to many factors, which may include:

- one assessor having a better understanding of the topic being assessed;
- one assessor being more familiar with the individual being assessed;
- one assessor being less focused during the assessment;
- one assessor allowing their emotions to affect their assessment; or
- one assessor being more experienced at assessing.



Did you know?

Assessment errors occur for a variety of reasons. Some errors can be caused by the design of the assessment, some occur only with certain groups of assessors, and some with individual assessors. The following are examples of common assessment errors:

1. **Error of central tendency.** Many assessors hesitate to assess either extremely high or extremely low. They tend to group their ratings close to the centre of the scale. If an error of central tendency is taking place, true ability is not reflected on the monitoring form. Therefore, the rating is of little use.
2. **Error of standards.** Some assessors tend to overrate or underrate everyone, as compared to the assessments of other assessors. They do this because of the difference in the standard they expect to see.
3. **Error of narrow criterion.** New assessors may use a narrow representation as the entire range of proficiency. If they have three superior instructors, they begin to assess others lower because they cannot perform quite as well.
4. **Logical error.** An assessor who has made a logical error allows the performance on one item to influence the assessing of another item. An alert assessor should assess each item separately and objectively.
5. **Error of familiarity.** When an assessor is with their instructors every day for a prolonged period, they can lose their assessing objectivity. They become accustomed to some of the instructors' common weaknesses and overlook them as errors. Stepping back and getting a new perspective helps to avoid this type of error.
6. **Error of halo.** Many assessors tend to assess after being influenced by their general impression of the individual. Halo error is so called because the assessment clusters like a halo around the assessor's general impression. An assessor must detach personal feelings about an instructor from the task being assessed. For example, an assessor assesses an instructor as high during a flight safety period because they speak well in a social environment; a quality which has nothing to do with flying an aircraft.

SECTION 2 THE PROCESS OF MONITORING INSTRUCTION

The process of monitoring instruction may be broken down into three stages: preparing for a monitoring session; monitoring a period of instruction; and debriefing the instructor.

PREPARING FOR A MONITORING SESSION

When preparing to monitor an instructor, an assessor must:

Advise the instructor. Advise the instructor well in advance that the lesson will be monitored and remind them that the purpose of monitoring a lesson is to give feedback to improve instructional skills.

Review the lesson. Review the lesson specification and determine how the lesson fits into the overall program by examining the lessons that precede and follow it. Consider different approaches to delivering the lesson based on the teaching points, ratio of theory to practical and amount of training activity required.

Review and prepare the assessment tools. Prepare the appropriate assessment tools, by filling in the:

- instructor's name,
- assessor's name,
- date,
- PO / EO,
- time allotted,
- any test details.

MONITOR A PERIOD OF INSTRUCTION

Monitoring a period of instruction can be broken down into three parts: before the lesson; during the lesson; and after the lesson.

Before the Lesson

1. Greet the instructor and request a copy of their lesson plan.
2. Reassure the instructor that the purpose of monitoring is to help the instructor develop their abilities and discuss any questions or concerns.
3. If possible, choose an observation point that is not in the direct line of sight of the learners or the instructor.
4. Verify that the training area has been appropriately arranged and training aids are available and in position.

During the Lesson

1. Observe the instructor's actions and learners' response during the lesson.
2. Use the assessment tools to help record behaviours. Focus on observable behaviours. Take descriptive notes and cite specific examples. The assessment tools allows the assessor to assess that:
 - a. the lesson plans are prepared and complete;
 - b. the training environment, including the layout of the training area and the orientation board, is appropriately prepared;

- c. the instructor uses appropriate instructional techniques and principles of instruction;
 - d. the instructor's ability to accommodate different learning styles in their lesson; and
 - e. the visual / training aids employed are unobstructed and easily viewed, relevant to the subject matter and allow for easy transition throughout the lesson.
3. Do not interfere with the lesson unless there is an emergency or safety violation.

After the Lesson

1. Complete the assessment tools.
2. Review the results of the assessment tools and identify items of the lesson that went well, and items of the lessons upon which the instructor needs to improve.

DEBRIEFING THE INSTRUCTOR

Debriefing sessions are used to let the instructor know of the strengths and weaknesses showed during the delivery of a lesson and develops a specific plan on how to overcome them. It is important that the assessor prepares a comfortable and relaxed atmosphere in the debriefing area by:

1. selecting a site for the debriefing area that is:
 - a. confidential and out of the hearing range of others; and
 - b. away from any potential distractions and interruptions;
2. arranging furniture in an informal manner (eg, not having a desk separate the assessor and the instructor); and
3. removing any physical barriers to the conversation (eg, other furniture, lamps, boxes).

Before meeting the instructor, the assessor must take time to plan the debriefing session. When planning the session, the assessor should:

1. review the notes taken during the lesson;
2. list the instructor's strengths during the lesson and how they contributed to achieving the instructional objective; and
3. list areas of improvement in the instructor's performance and how they detracted from the achievements of goals.

To ensure the efficiency and progression of the debriefing sessions, the assessor should:

1. welcome the instructor and put them at ease. Many instructors will be tense and the assessors are to make every effort to dispel this tension;
2. explain that the purpose of the session is to provide feedback which helps to improve their performance in the classroom;
3. employ active listening skills during the debriefing session. This also includes watching the instructor's body language; and

4. discuss the instructor's performance, to include:
 - a. asking questions that lead the instructor and encourage them to discuss their lesson;
 - b. asking the instructor to analyze their performance by identifying their strengths and areas for improvement;
 - c. responding to the instructor's self-evaluation and confirm areas identified as applicable;
 - d. identifying the strengths and areas for improvement if no areas are identified by the instructor (or if important areas are missed);
 - e. highlighting the effective areas of the instructor's performance and how this contributed to the achievement of the instructional objectives;
 - f. assisting the instructor to develop a plan to improve their instructional abilities;
 - g. having the instructor accept responsibility for the plan and commit to improve; and
 - h. offering further assistance if appropriate (eg, coaching in a particular area); and



It is important to limit the number of areas of improvement to two or three. If an instructor is given too many items to consider, they become overwhelmed. Identify two or three key points upon which the instructor to focus improvement.

5. conclude the session by having the instructor summarize what was discussed and re-motivate the instructor. It is important to allow the instructor to review the assessment tools.

The following is an example of a conversation that may occur during a debriefing session.

Monitor: "Hello Sgt Smith, how are you today?"

Sgt Smith: "I'm great, thank you!"

Monitor: "We're meeting to discuss the lesson you taught earlier. I want to remind you that the reason for this discussion is to help you improve as an instructor. First of all, looking back on the lesson, how do you think it went?"

Sgt Smith: "I think it went OK."

Monitor: "That's good. What do you think were your strengths during that lesson?"

Sgt Smith: "Well, I think I prepared good training aids and that I maintained a high level of class participation."

Monitor: "I agree with you. I also noticed that you created a lot of interest through the games you used to confirm the understanding of teaching points. You also placed emphasis on specific concepts by using very clear examples. I noticed that you had a great understanding of the lesson material. What do you think would be the areas in which you could improve for next time?"

Sgt Smith: "I realized at one point that I forgot a teaching point and had to go back to cover it, but I think in the end, the cadets understood the material because of my explanation. I also think I could have drawn answers from more cadets. I realized I only chose those who had raised their hands."

Monitor: "OK, you're right about those observations. How do you think you can improve on what you just told me?"

Sgt Smith: "Well, I could refer more to my lesson plan during the class to ensure I remain on track and don't forget any teaching points. I could also practice my lesson in advance to have a feel for the material. For my questioning techniques, I could plan different types of questions to ask during the class and write cues on my lesson plan to ensure I allow different people to answer questions and not only those who raise their hand."

Monitor: "That's a very good plan. Why don't you try those ideas during the next class that you'll teach and I could monitor one of your lessons next week. We can then discuss your progress."

Sgt Smith: "That sounds good!"

Monitor: "Can you summarize what we have just agreed upon?"

Sgt Smith: "I have to refer more to my lesson plan during the class to remain on track and not forget teaching points. I also need to practice my lesson in advance. And when I plan my lesson, I should incorporate different types of questions so that I don't always have the ones who raise their hand answer."

Monitor: "Very good. Feel free to drop by at any time if you need advice or help on anything. I'll look at the schedule tonight and let you know by tomorrow which lesson I'll monitor next week. Thanks for your time and your good work. Do you have anymore questions or comments?"

Sgt Smith: "No, not right now. Thanks very much."

Monitor: "Thank you, and have a good day."



Provide feedback to the Training Officer regarding the instructor's performance and progress.



Activate Your Brain #5:

What are the three stages to monitoring instruction?

1. _____
2. _____
3. _____



Activate Your Brain #6:

When giving a debriefing, how many items should you focus on? Why?

SECTION 3 MONITOR INSTRUCTION

PURPOSE

The purpose of this section is to provide an opportunity to monitor a period of instruction.

ACTIVITY INSTRUCTIONS

1. Liaise with your Proficiency Level Officer / Training Officer to establish which period of instruction you will be monitoring.
2. Using the Assessment Tools located at Attachment C, monitor a period of instruction.
3. Evaluate each item by following the Assessment Rubric and circle the corresponding letter on the Assessment Checklist. Record any strengths and areas for improvement in the comments section.
4. When the period of instruction is complete, finalize the Assessment Checklist.
5. Identify points to be discussed during the debriefing of the instructor.



The purpose of the debriefing is to provide the instructor feedback on their period of instruction.

6. Role-play a debriefing with your Proficiency Level Officer / Training Officer or the facilitator of this lesson. You will act as the assessor and the Proficiency Level Officer / Training Officer or the facilitator will act as the instructor.



Congratulations, you have completed your self-study package on EO C509.01 (Monitor Instruction). Complete the Assessment Checklist for the period of instruction you monitored and then hand it and the completed self-study package to the Training Officer / Proficiency Level Officer who will record your completion in your Proficiency Level Five logbook.

THIS PAGE INTENTIONALLY LEFT BLANK

SELF-STUDY PACKAGE ANSWER KEY



Activate Your Brain #1:

The aim of monitoring instruction is to improve instruction and learning. How is this done?

Monitoring instruction improves learning by promoting learning within the training environment, assessing whether learning is taking place, and providing opportunities for instructors to improve their instructional technique.



Activate Your Brain #2:

What are the three types of monitoring?

1. *Formal monitoring.*
2. *Informal monitoring.*
3. *Spot checks.*



Activate Your Brain #3:

What are the three types of assessment?

1. *Assessment by scale.*
2. *Assessment by rating.*
3. *Assessment by rubric.*



Activate Your Brain #4:

Why would assessment by rating be chosen over assessment by rubric?

Assessment by rating would be chosen over assessment by rubric because it is a faster assessment tool or if the task being assessed is simple and does not require additional assessment definitions.



Activate Your Brain #5:

What are the three stages to monitoring instruction?

1. *Preparing for a monitoring session.*
2. *Monitoring a period of instruction.*
3. *Debriefing the instructor.*



Activate Your Brain #6:

When giving a debriefing, how many items should you focus on? Why?

It is important to limit the number areas of improvement to two or three. If an instructor is given too many items to consider, they will become overwhelmed. Identify two or three key points for the instructor to focus improvement on.

ASSESSMENT CHECKLIST

Cadet's Name: _____ Corps: _____

Date: _____ Division: _____

	Assessment (circle one)	Notes
Lesson Preparation		
Lesson Plan	I D C E	
Instructional aids	I D C E	
Classroom / training area set-up	I D C	
Lesson Introduction		
Review of previous lesson (if applicable)	I D C	
Introduction of lesson	I D C E	
Lesson Body		
Method(s) of instruction	I D C	
Learning environment	I D C E	
Effective use instructional aids	I D C	
Satisfaction of learner needs	I D C E	
Accuracy of lesson content	I D C E	
TP confirmation	I D C E	
End of lesson confirmation	I D C E	
Lesson Conclusion		
Lesson summary	I D C	
Re-motivation	I C	
Description of next lesson	I D C	

I = Incomplete D = Completed With Difficulty C = Completed Without Difficulty E = Exceeded Standard

	Assessment (circle one)	Notes
Communication		
Voice control	I D C E	
Body language	I D C E	
Questioning techniques	I D C	
Time Management		
Time management	I D C	

I = Incomplete D = Completed With Difficulty C = Completed Without Difficulty E = Exceeded Standard

Assessor's Feedback:

Overall Assessment				
Check One	Incomplete	Completed With Difficulty	Completed Without Difficulty	Exceeded Standard
Overall Performance	The cadet has not achieved the performance standard by receiving an "incomplete" on more than three of the criteria listed on the assessment checklist.	The cadet has achieved the performance standard by receiving an "incomplete" on not more than three of the criteria and a minimum of "completed with difficulty" on all other criteria.	The cadet has achieved the performance standard by receiving a minimum of "completed with difficulty" on all criteria and "completed without difficulty" on 10 or more of the criteria.	The cadet has achieved the performance standard by receiving a minimum of "completed without difficulty" on all criteria listed and "exceeded standard" on 7 or more of the criteria:

Assessor's Name:	Position:
Assessor's Signature:	Date:

This form shall be reproduced locally

ASSESSMENT RUBRIC

	Incomplete (I)	Completed With Difficulty (D)	Completed Without Difficulty (C)	Exceeded Standard (E)
Lesson Preparation				
Lesson plan	The lesson plan was not submitted, it had insufficient detail to deliver a full period of instruction or it was not developed IAW the QSP.	The lesson plan was disorganized / hard to follow or was incomplete or included few details of how TPs are to be presented.	The lesson plan was neat and easy to follow. The introduction, body, end of lesson confirmation and conclusion were complete and accurate.	The lesson plan was neat and easy to follow. The introduction, body, end of lesson confirmation and conclusion were complete, accurate and detailed enough for another instructor to follow and implement without difficulty.
Instructional aids	The instructional aids were not developed, not relevant or were of poor quality.	The instructional aids were relevant, but their ease of use and effectiveness were questionable.	The instructional aids were relevant, easy to use and assisted in clarifying lesson content.	The instructional aids were relevant, easy to use and assisted in clarifying lesson content. In addition, instructional aids were creative, well thought-out and extra effort on the cadet's part was evident.
Classroom / training area set-up	Set-up of the classroom / training area was not suitable to the lesson.	Set-up of the classroom / training area was not suitable to the lesson, however some elements were overlooked.	The classroom / training area was well set up, with due consideration given to such things as: <ul style="list-style-type: none"> • functional seating formation, • lighting, and • instructional aids were easily accessible and ready to use, and • distractions were minimized. 	N/A
Lesson Introduction				
Review of previous lesson (if applicable)	The cadet did not review the previous lesson.	The cadet stated the topic of the previous lesson.	The cadet stated the topic of the previous lesson and provided a brief summary of the content.	N/A
Introduction of lesson	The cadet did not provide an introduction to the lesson.	The cadet stated what will be learned, but was unclear in the description of why it is important or where the knowledge / skills will be applied.	The cadet clearly described what will be learned, why it is important and where the knowledge / skills will be applied.	The cadet clearly described what will be learned, why it is important and where the knowledge / skills will be applied in a creative and engaging way.
Lesson Body				
Method(s) of instruction	The cadet's choice of method was not appropriate to the content or the audience.	The cadet's choice of method was appropriate but they displayed some difficulty using the method.	The cadet's choice of method was appropriate and they displayed no difficulty using the method.	N/A

	Incomplete (I)	Completed With Difficulty (D)	Completed Without Difficulty (C)	Exceeded Standard (E)
Learning environment	The cadet did not ensure the physical safety of the class, and/or the cadet made no attempt to employ stress and classroom management techniques, as described in EO M409.02.	The cadet ensured the physical safety of the class at all times. The cadet attempted to employ stress and classroom management techniques, however experienced difficulty using them effective and timely manner.	The cadet ensured the physical safety of the class at all times. The cadet employed stress classroom management techniques, as necessary, in an effective and timely manner.	The cadet ensured the physical safety of the class at all times. The cadet always controlled positive and negative stress, and displayed excellent classroom management techniques.
Effective use instructional aids	The cadet did not use instructional aids.	The instructional aids were difficult to see / use, or were introduced at an ineffective time.	The instructional aids were clearly displayed and were appropriately introduced.	N/A
Satisfaction of learner needs	The lesson was delivered in a way that was inappropriate for the developmental period of the audience and did not present visual, auditory or kinesthetic learning opportunities.	Some aspects of the lesson delivery were not appropriate for the developmental period of the audience. The cadet included little variety with regard to providing visual, auditory or kinesthetic learning opportunities.	The lesson satisfied the needs of the developmental period of the audience. The cadet included some variety of visual, auditory and kinesthetic learning opportunities.	The lesson satisfied the needs of the developmental period of the audience. The cadet included many visual, auditory and kinesthetic learning opportunities throughout the lesson.
Accuracy of lesson content	The cadet displayed limited understanding of the lesson content and was unable to provide accurate explanations, demonstrations and/or clarification.	The cadet displayed a general understanding of the lesson content but struggled with the explanation, demonstration and/or clarification of some of the content.	The cadet displayed a sound understanding of lesson content and provided accurate explanations, demonstrations and/or clarification without difficulty.	The cadet displayed a mastery of the lesson content.
TP confirmation	The cadet did not use questions or an activity to confirm the understanding of the TP content; and did not adjust the instruction based on audience comprehension.	The cadet used questions or an activity to confirm the understanding of the TP content, however made little effort to adjust instruction based on audience comprehension.	The cadet used questions or an activity to confirm the understanding of the TP content, and as necessary, attempted to adjust instruction based on audience comprehension.	The cadet creatively used questions or an activity to confirm the understanding at the end of each TP and easily adjusted instruction based on audience comprehension.
End of lesson confirmation	The knowledge or skills covered in the lesson were not confirmed using questions or an activity.	Questions or an activity was used as an end of lesson confirmation of knowledge or skills, however all teaching points were not covered.	Questions or an activity was used as an end of lesson confirmation of knowledge or skills and all teaching points were covered.	All knowledge or skills covered in the lesson were confirmed in a creative and engaging way.
Lesson Conclusion				
Lesson summary	The cadet did not re-state the objective of the lesson and did not summarize important points / areas for improvement.	The cadet re-stating the objectives of the lesson however struggled to summarize important points / areas for improvement.	The cadet re-stating the objectives of the lesson and concisely summarized important points / areas for improvement.	N/A
Re-motivation	The cadet did not attempt re-motivate the cadets.	N/A	The cadet attempted to re-motivate the cadets.	N/A

	Incomplete (I)	Completed With Difficulty (D)	Completed Without Difficulty (C)	Exceeded Standard (E)
Description of next lesson	The cadet did not describe the next lesson.	The cadet stated the topic of the next lesson.	The cadet stated the topic of the next lesson and provided a brief and accurate description of the lesson content.	N/A
Communication				
Voice control	The cadet did not speak clearly or consistently spoke to too quickly or quietly to be understood.	The cadet was understood, however struggled with the use of pitch, tone, volume, speed, and pauses to articulate and place emphasis on points where necessary.	The cadet spoke clearly and made clear attempts to control pitch, tone, volume, speed, and pauses to articulate and place emphasis on points where necessary.	The cadet spoke clearly and made excellent use of pitch, tone, volume, speed, and pauses to articulate and place emphasis on points where necessary.
Body language, dress and deportment	The cadet exhibited inappropriate body language and/or poor dress and deportment.	The cadet attempted to use body language to help communicate and emphasized points and exhibited acceptable dress and deportment.	The cadet easily incorporated the use of body language to help communicate and emphasize points and exhibited acceptable dress and deportment.	The cadet easily incorporated the use of body language to help communicate and emphasize points and exhibited a high standard of dress and deportment.
Questioning techniques	The cadet did not use any questions or apply the questions sequence (pose, pause, pounce, ponder and praise).	The cadet used appropriate types of questions but inconsistently applied the question sequence (pose, pause, pounce, ponder and praise).	The cadet used a variety questions and consistently applied the question sequence (pose, pause, pounce, ponder and praise).	N/A
Time Management				
Time Management	The lesson was not completed within the allotted time, with more than 5 minutes deviation.	Time planned for and/or spent on individual TPs / activities was somewhat inaccurate or insufficient however the lesson was completed within the allotted time (+ / - 5 minutes).	Time planned for and/or spent on individual TPs / activities was appropriate and the lesson was completed within the allotted time (+ / - 5 minutes).	N/A

Score overall assessment on the Assessment Checklist as:

1. **Incomplete.** If the cadet received an “incomplete” on more than three of the criteria listed on the assessment checklist;
2. **Completed With Difficulty.** If the cadet received an “incomplete” on not more than three of the criteria and a minimum of “completed with difficulty” or better on all other criteria;
3. **Completed Without Difficulty.** If the cadet received a minimum of “completed with difficulty” on all criteria and “completed without difficulty” or better on 10 or more of the criteria;
4. **Exceeded Standard.** If the cadet received a minimum of “completed without difficulty” on all criteria listed on the checklist and “exceeded standard” on seven or more of the criteria:

THIS PAGE INTENTIONALLY LEFT BLANK



ROYAL CANADIAN AIR CADETS
PROFICIENCY LEVEL FIVE
INSTRUCTIONAL GUIDE



SECTION 1

EO C530.01 – FLY A CROSS-COUNTRY FLIGHT USING A FLIGHT SIMULATOR

Total Time:	90 min
-------------	--------

PREPARATION

PRE-LESSON INSTRUCTIONS

Resources needed for the delivery of this lesson are listed in the lesson specification located in A-CR-CCP-805/PG-001, *Proficiency Level Five Qualification Standard and Plan*, Chapter 4. Specific uses for said resources are identified throughout the self-study package within the section for which they are required.

Self-study packages are intended to be completed by the cadet independently. More information about self-study packages can be found in the foreward and preface.

Review the lesson content and become familiar with the material prior to facilitating this lesson.

Photocopy the self-study package located at Attachment A for each cadet.

PRE-LESSON ASSIGNMENT

Nil.

APPROACH

A self study was chosen for this lesson as it allows the cadet to plan and fly a cross-country flight using a flight simulator at their own learning pace. This encourages the cadet to become more self-reliant and independent by focusing on their own learning instead of learning directed by the instructor.

INTRODUCTION

REVIEW

Nil.

OBJECTIVES

By the end of this lesson the cadet will have flown a cross-country flight using a flight simulator.

IMPORTANCE

It is important for cadets to practice the aviation theory they have learned throughout their cadet training by flying a cross-country flight using an aircraft flight simulator as it will reinforce learning and stimulate interest in future aviation training.

SELF-STUDY PACKAGE INSTRUCTIONS

OBJECTIVE

The objective of this self-study package is to have the cadet fly a cross-country flight using a flight simulator.

RESOURCES

- Self-study package,
- Visual Flight Rules (VFR) Navigation Chart (VNC),
- ICAO chart ruler,
- Flight computer,
- Flight simulator (Microsoft flight simulator, computer, control yoke, and rudder pedals[joystick]; or Link),
- Pen / pencil.

ACTIVITY LAYOUT

Provide the cadet with a classroom or training area suitable to complete the self-study package.

ACTIVITY INSTRUCTIONS

1. Provide the cadet with a copy of the self-study package located at Attachment A and a pen / pencil.
2. Allow the cadet 90 minutes to complete the self-study package.
3. Provide assistance as required to the cadet.
4. Collect the self-study package once the cadet has finished.
5. Provide feedback to the cadet and indicate whether or not they have completed the Enabling Objective (EO).
6. Return the completed self-study package to the cadet for their future reference.
7. Record the result in the cadet's logbook and Cadet Training Record.

SAFETY

Nil.

END OF LESSON CONFIRMATION

The cadets' participation in flying a cross-county flight using a flight simulator will serve as the confirmation of this lesson.

CONCLUSION

HOMEWORK / READING / PRACTICE

Nil.

METHOD OF EVALUATION

Nil.

CLOSING STATEMENT

It has been stated by many flight instructors that a significant difference can be seen in the quality of students have used a flight simulator compared to those who did not. Continued training on flight simulators will enhance preparation for future flight training.

INSTRUCTOR NOTES / REMARKS

Nil.

REFERENCES

A0-001 A-CR-CCP-263/PT-001. (2000). *From the ground up*. Ottawa, ON: Aviation Publishers Co. Ltd.

C3-345 Flight Simulator Navigation. (2009). *Air navigation*. Retrieved October 22, 2009, from <http://www.navfltsm.addr.com.basic-nav-general.htm>

THIS PAGE INTENTIONALLY LEFT BLANK

Fly a Cross-Country Flight Using a Flight Simulator

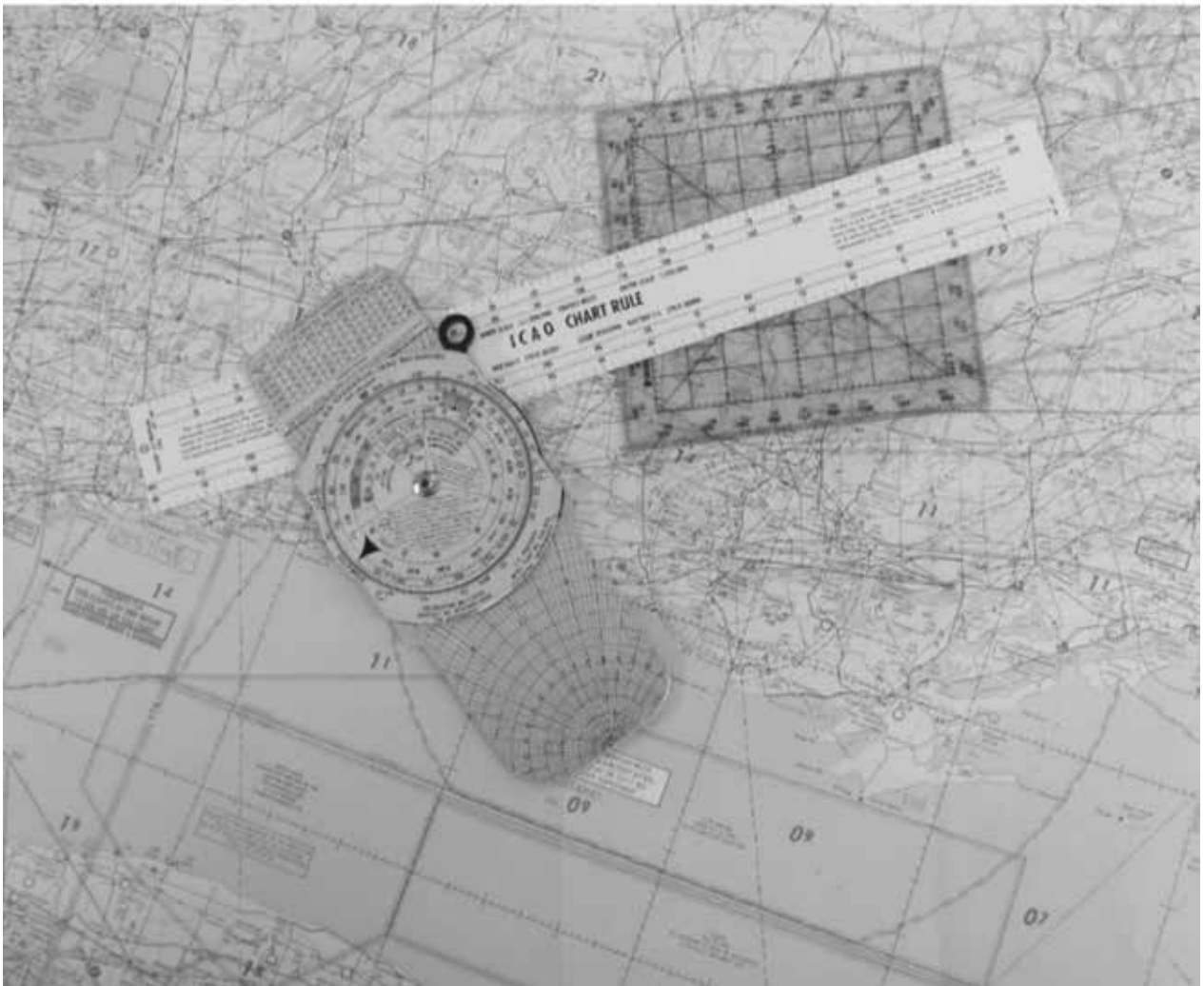

SECTION 1: PLOT A VISUAL FLIGHT RULES (VFR) CROSS-COUNTRY FLIGHT ON A VNC

SECTION 2: DETERMINE AIRCRAFT SPEED

SECTION 3: FLY A CROSS-COUNTRY FLIGHT

SECTION 1

PLOT A VISUAL FLIGHT RULES (VFR) CROSS-COUNTRY FLIGHT ON A VNC

AIRPORT SELECTION

Pilotage



Did you know?

Pilotage is navigating from place to place by following visual landmarks on the ground.

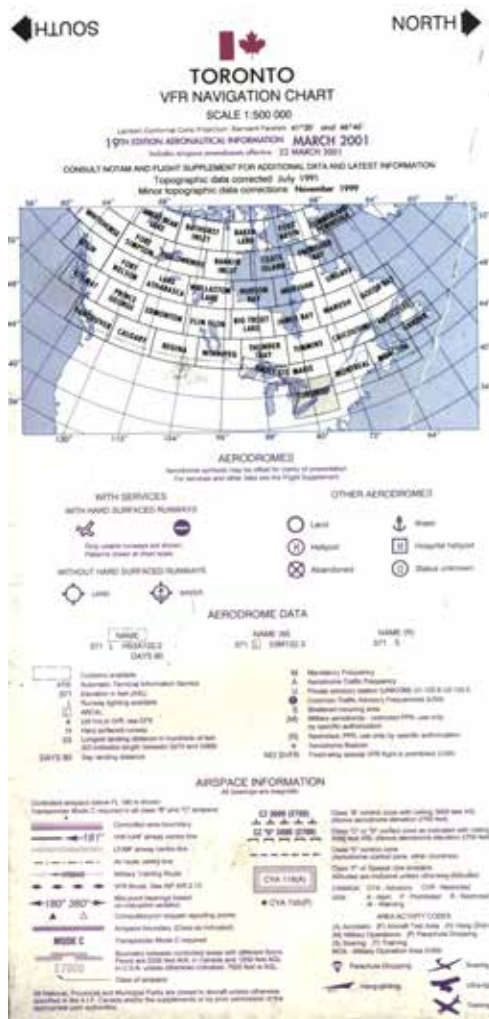

Using a Visual Flight Rules (VFR) Navigation Chart (VNC), select two airports for the flight scenario, including:

1. the departure airport, and
2. the arrival airport.

Figure A-1 VNC Cover

Note. From *Toronto VFR Navigation Chart*, by Department of Natural Resources, 2001, Ottawa, Ontario: Geomatics Canada. Copyright 2001 by Nav Canada.

Coordinates



For each airport, identify the following:

- airport identification letters (1), and
- airport VNC coordinates (2).

Figure A-2 VNC Map Coordinates

Note. Created by Director Cadets 3, 2009, Ottawa, ON: Department of Defence.



Activate Your Brain #1:

What two airports will you be using?

Airports	Coordinates
_____	_____
_____	_____

Distance

Nautical Miles

Measure the distance to each turning point, totaling the distance between the two airports.



You will be flying a Visual Flight Rules (VFR) flight. The route between airports should have highways, rivers, towns / cities, and other landmarks visible from the air.

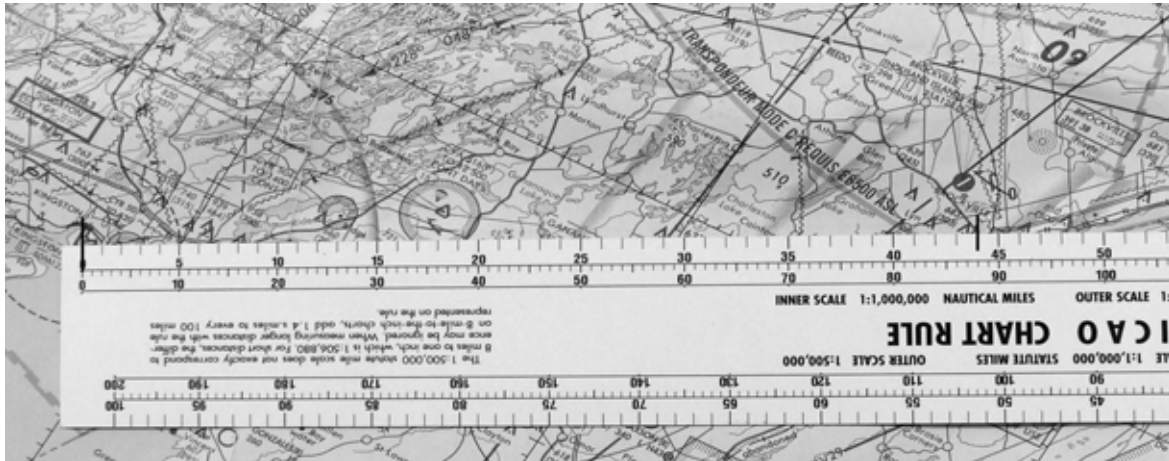

Figure A-3 ICAO Chart Ruler

Note. Created by Director Cadets 3, 2009, Ottawa, ON: Department of Defence.



Activate Your Brain #2:

What is the distance between the two airports? Each turning point will have a distance in nautical miles (record as many turning points as required to arrive at the second airport).

- First measurement: _____
- Second measurement: _____
- Third measurement: _____
- Fourth measurement: _____
- Fifth measurement: _____
- Total distance:** _____

Convert the distance from nautical miles to statute miles using a flight computer. Using the inside ring, set the nautical miles on the nautical mile mark on the outside ring. Read the number on the second ring corresponding to the statute mile mark on the outside ring.



Figure A-4 Flight Computer

Note. Created by Director Cadets 3, 2009, Ottawa, ON: Department of Defence.



Activate Your Brain #3:

What is the distance between the two airports in statute miles?

Nautical Miles

Statute Miles

Landmarks

Using the VNC, identify landmarks along the flight route that will be visible from the aircraft.

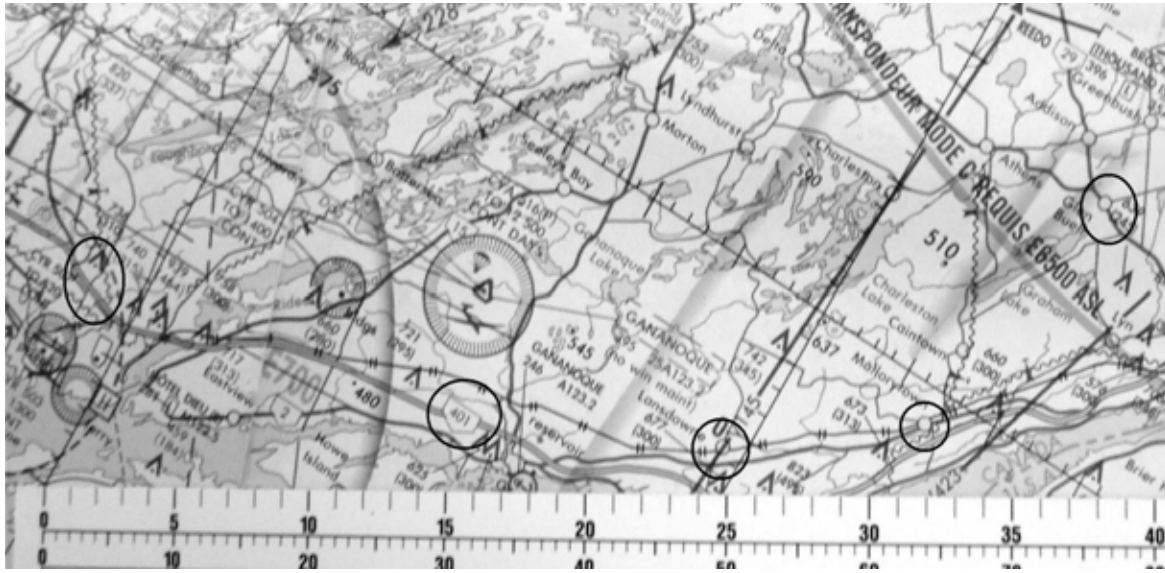

Figure A-5 Landmarks

Note. Created by Director Cadets 3, 2009, Ottawa, ON: Department of Defence.



Activate Your Brain #4:

What are the landmarks you will be following between the two airports? List as many as required.

- First landmark: _____
- Second landmark: _____
- Third landmark: _____
- Fourth landmark: _____
- Fifth landmark: _____

SECTION 2
DETERMINE AIRCRAFT SPEED

AIRCRAFT SPEED

Calculate the airspeed you will need to fly to arrive at your arrival airport. The formula to calculate is:

Speed (unknown ground speed) X **Time** (known [.5 hour]) = **Distance** (known)

As the speed is unknown, you will use the formula:

Distance / Time = Speed (D / .5 = S)



Activate Your Brain #5:

What is the aircraft speed required to fly between the two airports?

Distance	Divided by	Time	Equals	Speed
_____	/	_____	=	_____
		.5		

To finalize your scenario, the following knowns will be set in the simulation program, including:

- clear daylight,
- no wind,
- altitude is 1 200 feet, and
- aircraft to fly, to include:
 - Piper J-3C Cub, or
 - Cessna C172.



Did you know?

The Piper J-3C's maximum speed is 74 kts (85 mph / 137 km/h).

The Cessna C172's maximum speed is 126 kts (203 km/h).



Variations from this criteria can be made to adjust for the area in which you are flying.

Complete the flight plan sheet using the data from the Activate Your Brain boxes.

FLIGHT PLANNING WORKSHEET

Date: _____ **Depart:** _____ **Destination:** _____
 Airport, ID and coordinates Airport, ID and coordinates

Distance to travel: _____
 one-way

Altitude: _____

Airspeed: _____

Landmarks	Description of landmark	Time arrived at landmark
1		
2		
3		
4		
5		
6		
7		
8		
9		
10		

Airports	Timings
Depart 1	
Arrive 2	
Depart 2	
Arrive 1	

SECTION 3
FLY A VFR CROSS-COUNTRY FLIGHT USING A FLIGHT SIMULATOR

Start the flight simulator with the scenario you created.

Using the flight simulator, fly the VFR cross-country flight at 1 200 feet AGL. Once you arrive at the first airport, land and then take off for a return flight to the original airport where you will land and taxi to the gas pumps.

Fill in the times as required during the flight on the Flight Planning Worksheet.

CONCLUSION

The knowledge to fly a cross-country flight has been developed over your four years of cadet training. Users of computer-based flight simulators have enhance their knowledge for future flight training.



Congratulations, you have completed your self-study package on EO C530.01 (Fly a Cross-Country Flight Using a Flight Simulator). Hand your completed package to the Training Officer / Proficiency Level Officer who will record your completion in your Proficiency Level Five logbook.



ROYAL CANADIAN AIR CADETS
PROFICIENCY LEVEL FIVE
INSTRUCTIONAL GUIDE



SECTION 1

EO C540.01 – REFLECT ON CANADA'S CONTRIBUTION TO AEROSPACE TECHNOLOGY

Total Time: 90 min

PREPARATION

PRE-LESSON INSTRUCTIONS

Resources needed for the delivery of this lesson are listed in the lesson specification located in A-CR-CCP-805/PG-001, *Proficiency Level Five Qualification Standard and Plan*, Chapter 4. Specific uses for said resources are identified throughout the self-study package within the section for which they are required.

Self-study packages are intended to be completed by the cadet independently. More information about self-study packages can be found in the foreword and preface.

Review the lesson content and become familiar with the material prior to facilitating this lesson.

Photocopy the self-study package located at Attachment A for each cadet.

Photocopy the answer key located at Attachment B but **do not** provide it to the cadets.

PRE-LESSON ASSIGNMENT

Nil.

APPROACH

A self study was chosen for this lesson as it allows the cadet to reflect in greater detail on Canada's contribution to aerospace technology at their own pace. This encourages the cadet to become more self-reliant and independent by focusing on their own learning instead of learning directed by the instructor.

INTRODUCTION

REVIEW

Nil.

OBJECTIVES

By the end of this lesson the cadet shall have reflected on Canada's contribution to aerospace technology.

IMPORTANCE

It is important for cadets to recognize the contribution Canadian researchers, scientists and technicians have made to the development of aerospace technology, not only for Canada but the world. Canadian technical knowledge has assisted aerospace development to create global advances within the space program and aircraft development.

SELF-STUDY PACKAGE INSTRUCTIONS

OBJECTIVE

The objective of this self-study package is to have the cadet reflect on Canada's contribution to aerospace technology.

RESOURCES

- Self-study package, and
- Pen / pencil.

ACTIVITY LAYOUT

Provide the cadet with a classroom or training area suitable to complete the self-study package.

ACTIVITY INSTRUCTIONS

1. Provide the cadet with a copy of the self-study package located at Attachment A and a pen / pencil.
2. Allow the cadet 90 minutes to complete the self-study package.
3. Provide assistance as required to the cadet.
4. Collect the self-study package once the cadet has finished.
5. Correct the self-study package with the self-study package answer key located at Attachment B.
6. Provide feedback to the cadet and indicate whether or not they have completed the Enabling Objective (EO).
7. Return the completed self-study package to the cadet for their future reference.
8. Record the result in the cadet's logbook and Cadet Training Record.

SAFETY

Nil.

END OF LESSON CONFIRMATION

The cadet's participation in reflecting on Canada's contribution to aerospace technology will serve as the confirmation of this lesson.

REFERENCES

C3-346 ISBN 978-1-55002-940-6 Melady, J. (2009). *Canadians in space: The forever frontier*. Toronto, ON: Dundurn Press.

C3-347 Aerospace and Defence. (2008). *Canada's evolving position in the aerospace environment*. Retrieved October 23, 2009, from <http://www.ic.gc.ca/eic/site/ad-ad.nsf/eng/ad03879.html>

C3-356 Centennial of Flight (2009). *Avro Canada*. Retrieved December 4, 2009 from http://www.centennialofflight.ca/airforce/hist/history_Avro_Canada_e.php

C3-357 page.interlog.com (2004). *Avrodemo timeline*. Copyright 1998–2004 by Art and Industry/20th Century Limited. Retrieved December 4, 2009 from <http://pages.interlog.com/~urbanism/adrodemo.html>

THIS PAGE INTENTIONALLY LEFT BLANK

Reflect on Canada's Contribution to Aerospace Technology



**SECTION 1: ACCOMPLISHMENTS UP TO THE CANCELLATION OF THE AVRO CANADA
CF-105 ARROW PROJECT**

SECTION 2: THE ACCOMPLISHMENTS OF FORMER AVRO CANADA LIMITED PERSONNEL

SECTION 3: CANADA'S CONTRIBUTION TO THE SPACE PROGRAM

SECTION 4: CANADA'S CONTRIBUTION TO AIRCRAFT DEVELOPMENT

SECTION 1
THE ACCOMPLISHMENTS UP TO THE CANCELLATION
OF THE AVRO CANADA CF-105 ARROW PROJECT

Canada's interest in space began well before we were a country. The first astronomical observatory was located in the French colony in Louisbourg on the coast of Cape Breton Island. As the country grew, observatories were developed in Quebec, in Quebec City and Montreal, and in Ontario, in Kingston and Toronto.



Did you know?

The first recognized Department of Astronomy was formed at the University of Toronto in 1904.

With the interest in the north magnetic pole and its affect on radio waves, further examination of the sky was conducted with telescopes and weather balloons. Communication during World War II (WWII) became increasingly important. Scientists found that signal strength rises and falls depending on how high on a promontory or how low in a valley you are.



Did you know?

By the mid 1950s, the ideas of man-made satellites were being discussed. To launch a satellite was the problem.

Experimentation with rockets was mainly being conducted near Churchill, Manitoba jointly between Americans and Canadians. Research was being conducted by the Bristol Aerospace Company in Winnipeg, Manitoba in conjunction with the Ottawa-based Defence Research Board.

Many well known scientists worked on the development of rockets, including a little known Canadian, Dr. John Chapman. Dr. Chapman's contribution to space flight and space flight technology is unparalleled in our country.



Did you know?

The Canadian Space Agency headquarters site at Longueuil, Quebec is named The John H. Chapman Space Centre after Dr. Chapman.

As a Royal Canadian Air Force (RCAF) officer, Dr. Chapman learned and worked in the developing field of radar. After the war, he returned to Canada, received his doctorate in physics and became involved in ever-increasing leadership roles at the Defence Research Telecommunication Establishment.

When the Russians launched Sputnik in 1957, the Russian-American rivalry began. The Defence Research Telecommunication Establishment was among the first to detect and monitor the sounds of the satellite.



Figure A-1 Sputnik

Note. From "About.com". *Sputnik 1 Mockup*. Retrieved December 4, 2009, from <http://www.space.about.com/od/sputnik/ig/Sputnik-a-Pictures-Gallery/Sputnik-a-Mockup.htm>

With the Russian success, and the successful launch of Explorer 1 in 1958 by the Americans, Canada realized that they too could have a satellite in space. The team in Ottawa, Ontario lead by Dr. Chapman started working on this problem. If they could develop a satellite for Canada, perhaps the Americans would launch the satellite.

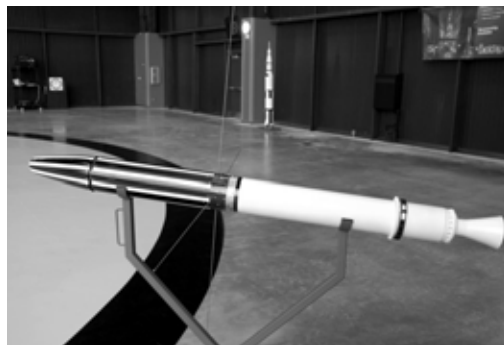

Figure A-2 Explorer 1

Note. From "U.S. Space & Rocket Center", 2009, *U.S. Space & Rocket Center Official Gallery-Interior/Explorer 1-8*. Copyright 2009 by U.S. Space & Rocket Center. Retrieved December 2, 2009, from <http://www.spacecamp.com/gallery/displayimage.php?album=36&pos=1>



Did you know?

When the National Aeronautic and Space Administration (NASA) was formed, they started examining American achievements including Canadian successes with space research. NASA started as a bureaucracy to keep track of space-related advances and to lend cohesion to the progress that was being made in the space field.

In 1959, NASA agreed to launch the Canadian satellite built by Dr. Chapman and his team with the understanding that any information would be shared with other countries.

The Americans already had close connections with the Canadian capabilities and resourcefulness. The Storable Tubular Extendible Member (STEM) antenna was invented by George Klein, an engineer with the National Research Council (NRC) and built by Spar Aerospace Limited (Ltd.). It was used on all early American–manned space flights, including John Glenn's (first American astronaut) launch into space.



If you want to read more about NRC engineer George Klein, you can go to <http://www.nrc-enrc.gc.ca/eng/education/innovations/discoveries/stem.html>

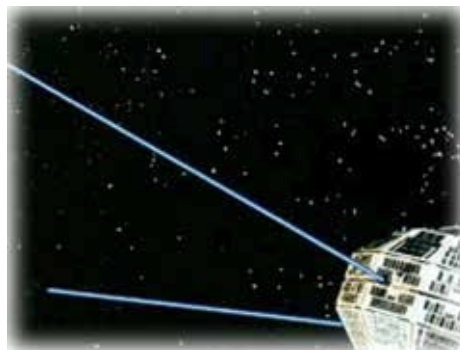

Figure A-3 STEM Protruding from Alouette

Note. From "Canada Science and Technology Museum", 2009, *Background Information for Canada in Space*. Copyright 2009 by Canada Science and Technology Museum. Retrieved December 4, 2009, from http://www.sciencetech.technomuses.ca/English/schoolzone/Info_Space.cfm



A STEM antenna, a flat strip of steel, unrolls when the satellite reaches its orbit and remains rigid when it is deployed.

Canada was launching scientific research Black Brants rockets starting in 1959, from Churchill, Manitoba. The first rocket carried a 100–kg payload to an altitude of 99 km.



Did you know?

The first Canadian satellite, Alouette 1, was launched by an American Thor-Agena rocket on September 26, 1962 in California. Alouette 1 was designed and built in Canada and had four STEM antennas. It took 20 years before Canadians were invited to become part of NASA.

While space development was progressing, aircraft development was also achieving advancements. In 1937, Malton, Ontario was selected to house Victory Aircraft. In 1945, A. V. Roe Canada Ltd. purchased Victory Aircraft as a repair and maintenance shop for aircraft. The company became known as Avro Canada.

In 1946, Avro purchased Turbo Research Ltd. to continue working on jet engines. In 1954, the Gas Turbine Division of Avro became a separate company, Orenda Engines Ltd. The Orenda engine was to be the main focus for the CF-100, F-86 and later the CF-105, as well as other countries' aircraft.

In 1953, Avro received contracts to develop a powerful interceptor aircraft to counter the Russian development of jet-powered bombers.



Did you know?

In 1952, Avro Special Projects teams started research and development on a vertical lift flying saucer-like vehicle (Avro VZ-9-AV Avrocar) funded by the United States Air Force (USAF).

The Avro Arrow was developed and proved to be an outstanding aircraft, ahead of its time. Tests flights were started in 1958 by chief test pilot Jan Zurakowski. At the same time, the Astra fire-control and Sparrow missile program were experiencing major developmental problems and creating major cost overruns. The overall costs for the Arrow project were several million dollars and increasing.



Figure A-4 CF-105 Avro Arrow

Note. From "Military Pictures", 2006, *Avro Arrow*. Copyright by MilitaryPictures.Info. Retrieved December 3, 2009, from http://www.militarypictures.info/airplanes.avro_arrow.jpg.html



Did you know?

Engineers overcame many difficulties in aircraft design at this time, including:

- wave drag at supersonic speeds:
 - used a thicker airfoil, and
 - swept airfoil rearward at a sharp angle; and
- delta wings provided:
 - more internal room for more fuel,
 - larger surface area providing ample lift at high altitudes, and
 - difficulty with increased drag at lower speeds and altitude.

NRC studied the Arrow project and was critical of the aircraft's maneuverability at altitude and range.

On September 23, 1958, the Astra and Sparrow programs were cancelled. The government cancelled the complete Arrow program on February 20, 1959. All aircraft, engines, production tools and technical data were ordered to be destroyed.



Did you know?

The Royal Canadian Mounted Police (RCMP) feared that foreign countries were spying on the development of the Arrow for technical secrets. The Mitrokhin archives (secret notes made by Vasili Mitrokhin on the Soviet Union secret police [KGB] activities and agents while working for over 30 years in the foreign intelligence archive) proved to some extent that this was happening.

At the time, foreign interest was low and the US Air Force was developing three aircraft similar to the performance of the Arrow (F-101 Voodoo, F-102 Delta Dagger and F-102B). The NRC was not interested in the Arrow, as there would be a shortage of spare parts, maintenance and qualified pilots available.



Did you know?

The NRC was against the program from the beginning.

Avro Canada continued on for several years but by 1962, the end arrived. The site was purchased by MacDonnell Douglas of Canada in 1963 and then Boeing Canada in 1997.



Did you know?

Most of the Avro site is now part of the Greater Toronto Airport Authority as Pearson International Airport.

The greatest loss was the departure of the bright minds of Avro Canada.



Activate Your Brain #1:

Name the importance for each of the following:

- University of Toronto _____
- Dr John Chapman _____
- George Klein _____
- A. V. Roe Canada Ltd _____

SECTION 2

THE ACCOMPLISHMENTS OF FORMER AVRO CANADA LIMITED (LTD.) PERSONNEL

The cancellation of both the Astra and Sparrow program and the Arrow program cost 14 000 employees their jobs.

A.V. ROE CANADA COMPANY DISPERSION

Special Projects A. V. Roe became SPAR Aerospace. Orenda Engine continued operation and is now the leading industry in the Canadian company Magellan Aerospace Group. Skilled employees with these companies assisted with future successes.

Canadian Steel Improvement, Ltd. was the third company in the A.V. Roe Canada group. They continued development and engineering operations with a name change in 1969 to SIFCO Industries, Incorporated (Inc.). With the expertise and leadership by Charles H. Smith, SIFCO Industries, Inc. is a worldwide supplier to the developing aviation industry.

FORMER AVRO CANADA LTD PERSONNEL

Jim Floyd

Avro vice-president of engineering Jim Floyd worked with Avro technicians to find them employment with American aerospace companies such as Lockheed, Boeing, General Electric (G. E.) and Pratt & Whitney. Jim Floyd returned to Britain and worked with the Supersonic Transport studies that led to the development of the Concorde.

Jim Chamberlain

NASA had formed the Space Task Group (STG) to put astronauts in space. Engineers and scientists were recruited to work on the Mercury, Gemini and Apollo programs. Avro chief of technical design Jim Chamberlain lead the Canadians at the STG and was instrumental in the design of the Mercury capsule.

Jim Chamberlain was the head engineer of the Mercury project. He then designed the Gemini spacecraft which moved the American Space Program ahead of the Russian Space Program. He was responsible for selecting the moon orbit approach for the Apollo missions. He worked with Owen Maynard to develop the lunar module (LM) system.

Owen Maynard

Owen Maynard joined the STG and participated in the planning and development of getting astronauts to and from the lunar surface. He was instrumental as a team member with the initial designs of the Apollo command and service modules. When the accepted method of getting the astronauts to and from the moon's surface was decided, Owen Maynard's design for the LM was accepted and used. Owen Maynard was the chief of the LM engineering office. He later was promoted to the position as chief of the systems engineering division for the Apollo Spacecraft Program.



Did you know?

Thomas J. Kelly is known as the father of the LM but he acknowledges Owen Maynard as the person at NASA most responsible for the design of the LM.



Figure A-5 Lunar Module (LM-2)

Note. From "Historic Spacecraft", 2009, *Lunar Module*. Retrieved December 7, 2009, from http://www.historicspacecraft.com/Lunar_Module.html

Other ex-Avro employees went to work at NASA's Mission Control:

Christopher Kraft

Christopher Kraft became Flight Director at Mission Control and later the director of the Johnson Space Center in Houston, Texas. He and Gene Kranz were active during the Apollo 13 missions.

Jim Hodge

Jim Hodge was an original flight director at Mission Control. He, along with ex-Avro employees, Dennis Fielder, Tec Roberts and Fred Matthews, assisted in building Mission Control and the network of tracking stations that guided Mercury, Gemini and Apollo programs. He returned to NASA in the 1980s to launch the Space Station Program.

Bruce Aikenhead

Bruce Aikenhead joined NASA and worked for three years training astronauts. He returned to Canada to work with Gerry Bull and later on Canadian satellites, the Remote Manipulator System (Canadarm) and the Canadian Astronaut Program.



Did you know?

Dr. Gerry Bull, the youngest full professor appointed by McGill University, proposed launching satellites into orbit using a gun.

Thomas Loudon and Ben Etkin

Within Canada, new challenges were faced by ex-Avro engineers. Thomas Loudon and Ben Etkin remained in Canada and taught at the University of Toronto Institute for Aerospace Studies (UTIAS) as members of the Faculty of Applied Science and Engineering in Ontario.



Activate Your Brain #2:

Who were we?

SPAR

Magellan Aerospace Group

SIFCO Industries, Incorporated (Inc.)

SECTION 3 THE CANADIAN CONTRIBUTION TO THE SPACE PROGRAM

SPACE DEVELOPMENT

Aerospace and defence have become a global industries. Countries are willing to share knowledge and work collectively. Canada aerospace and defence industries have proved a valued member in these evolving industries.

Original equipment manufacturers (OEM) like Bombardier, CAE, Pratt & Whitney Canada, Bell Helicopter Textron Canada and General Dynamics Canada continue to contributed and develop new technology.

Satellite Development

Satellite development continued with Dr. Chapman with his proposal to change the development from scientific satellites to communication satellites. This lead to the joint Department of Communications (DOC) and NASA project using Hermes. Hermes had large solar panels that folded out like an accordion once the satellite reached its orbit.



Did you know?

Hermes was the first high powered satellite in orbit which led to present day satellites used to broadcast television directly to individual homes using small low-tech satellite dish antennas.



Figure A-6 Hermes Spacecraft

Note. From "Friends of CRC / Les Amis du CRC", 2001, *Hermes*. Copyright by Friends of CRC.
Retrieved December 7, 2009, from <http://www.friendsofrc.ca/Projects/Hermes/hermes.html>

To test a satellite before flight in a thermal vacuum chamber, the David Florida Lab (DFL) near Ottawa, Ontario was built. A satellite was tested in the Thermal Vacuum Facility which simulated the temperature and vacuum of space, cycling through hot and cold temperatures. The facility also tested the satellite in a spin machine, simulating spinning in space.

The satellite was also tested in the Vibration Test Facility, shaking the satellite to ensure that it would withstand the vibrations and shock of the launch. Radio frequency testing was also performed in the reflection-free chamber duplicating the conditions of space.



Did you know?

The DFL was named after David Florida, a Canadian space pioneer who managed the team that built the International Satellites for Ionospheric Studies.

In 1991, the Anik-E series of satellites was built by Spar Aerospace but launched by the European Space Agency. The E2 satellite was not test at the DFL due to it being too large for the facility and when in space, the antenna triggers would not release. The technicians, including DFL staff showed that satellites in space could be rescued from Earth. They received awards for the rescue of the satellite.



Did you know?

Telesat, owner / operator of the satellite, received two awards for the rescue, including:

- first ever Space Recovery Prize from La Réunion Spatiale, and
- International Space Risk Insurance Group.

Canadarm

With the development of the space shuttle program, NASA turned to Canada for the development of a lifting and placement machine. The Remote Manipulator System (Canadarm) was the result of work by Spar Aerospace.



Did you know?

Canadarm is a robotic arm that allows astronauts to work in space, to include:

- releasing and retrieving satellites in space;
- working in the cargo bay from the safety of the flight deck; and
- serving as a platform from which an astronaut outside of the cargo bay can:
 - repair satellites,
 - assemble tasks, and
 - disassemble tasks.

CANADIAN ASTRONAUTS

In 1982, Canadian astronauts were invited to train and soon fly, with the United States Space Shuttle Program. Men and women joined the Canadian Space Agency and provided specialist roles within the NASA program. Not all Canadian astronauts flew in space.



This list of Canadian astronauts is current as of 2010. Go to the Canadian Space Agency at <http://www.space.gc.ca> to find out about Canadians who have since become astronauts.

Marc Garneau

Marc Garneau was the first Canadian to fly in space in 1984. His role was as a Payload Specialist working on several scientific exercises that would further benefit the on-going flight and future space missions. He also was tasked with taking photographs of the aurora borealis. He flew again in 1996 as a Mission Specialist and again in 2000 when he directed three spacewalks at the International Space Station (ISS) and worked the Canadarm.

He served as the first non-American capsule communicator (CAPCOM). Marc Garneau was the Deputy-Director of the Canadian astronaut program. When he retired as an astronaut in 2000, he became president of the Canadian Space Agency (CSA).



Did you know?

Marc Garneau spoke at community gatherings on his return, showing the pictures he took. Many cadets and officers witnessed the photographic wonders taken during the first flight in the mid 1980s.

The Canadian-built IMAX camera was used on this flight.

Roberta Bondar

Roberta Bondar was the second Canadian astronaut and the first Canadian woman to fly into space with the United States Space Shuttle Program. She was a Payload Specialist and worked in a science lab call Skylab in 1992. She conducted a teleconference with 1 000 elementary school students and teachers from space at the Ontario Science Centre in Toronto, Ontario.



Did you know?

Ken Money was her backup astronaut. He never flew into space and left NASA after the Bondar flight.

Steve MacLean

In 1992, Steve MacLean flew as a Payload Specialist and on his second flight in 2006, he was a Mission Specialist. Steve MacLean's primary duty on the first mission was to operate the prototype of the Canadian Space Vision System (SVS). He was one of three Canadian astronauts who participated in a spacewalk. He became the first Canadian to operate the Canadarm2 in space.

In 2008, Steve MacLean was appointed head of the CSA.



Did you know?

SVS links computers with television cameras, shooting targets on satellites or other vehicles to provide real-time computer images of where the Canadarm is in relationship to the object it needs to grasp.

With the SVS, the Canadarm operators are able to see what they are doing, even if the arm is manoeuvring something that cannot be seen from the flight deck.

Chris Hadfield

Chris Hadfield flew in 1995 and was the only Canadian to visit the Russian Space Station Mir. He also was the first Canadian Mission Specialist to fly during the 1995 shuttle flight. He was the senior member of three men, with the same qualifications. He continued his flight of firsts as the first Canadian to operate the Canadarm in space. His 2001 flight carried the new Canadarm2 to be installed to the ISS. He was one of three Canadian astronauts who participated in a spacewalk.

Chris Hadfield worked as a CAPCOM.



Did you know?

Chris Hadfield started his flying as an air cadet with 820 Squadron, Milton, Ontario. He trained at the Central Region Gliding School, at Canadian Forces Detachment Mountainview, Ontario.

He joined the Canadian Forces and graduated from Royal Military College (RMC) located in Kingston, Ontario.

He left the Air Force as a colonel and during his career, was the U.S. Navy Test Pilot of the Year in 1992.

Robert (Bob) Thirsk

Bob Thirsk was the backup astronaut for Marc Garneau. He filled the role as CAPCOM in the space station control room. He flew in the shuttle in 1996 and with Soyuz in 2009 when he became the first Canadian to live and work on the International Space Station (ISS).

Dave Williams

Dave Williams flew in 1998, as a Mission Specialist and again in 2007. He made three spacewalks, and was the manager of the Missions and Space Medicine Group in the Canadian Astronaut Program. After completing his first flight, he was appointed as the first non-American director of the Space and Life Sciences Directorate at the Johnson Space Center. He was commander for NASA Extreme Environment Mission Operations (NEEMO) for an 18-day mission.



Did you know?

The NASA research facility called NEEMO simulates weightlessness for astronauts in an underwater setting. Astronauts prepare and train for duty in the ISS.

Bjarni Tryggvason

Bjarni Tryggvason was the backup astronaut of Roberta Bondar in 1992. He flew as a Payload Specialist in 1997. His primary role was performing fluid science experiments, the background work largely a Canadian experiment.



Did you know?

Bjarni Tryggvason was born in Iceland and had not seen an aircraft as a young boy. He and his family came to Canada when he was 14 years old. He became a Canadian citizen as a youngster and was a member of the Air Reserve as a teenager when his family settled in British Columbia.

Julie Payette

Julie Payette first flew in 1999, as the first Canadian to participate on the assembling of the ISS. Her second flight was in 2009, as a Mission Specialist.

Drew Feustel

Drew Feustel flew into space in 2009. He was a member of the last flight to the Hubble Telescope. He completed three spacewalks during the space flight.



The space flights continue with Canadian astronauts flying with the Shuttle and the Soyuz programs to the ISS. Their stay at the ISS may be long or short.



Did you know?

Canada contributes to space and aeronautical developments with NASA and also Russia, the European Space Agency, Japan and other countries.

Canadian technological contributions to the space shuttles, the ISS and the unmanned space program are numerous, including:

- Canadarm,
- Canadarm2,
- Special Purpose Manipulator (Dextre),
- weather station on the Phoenix Mars Lander,
- Radarsat-2 satellite which is monitoring the Northwest Passage, and
- communications, such as:
 - television,
 - radio,
 - cell phones, and
 - Internet.



Did you know?

The Radarsat-2 satellite was the only satellite to spot a US submarine sailing through the Northwest Passage.



Activate Your Brain #3:

When did they go into space?

Marc Garneau	_____
Roberta Bondar	_____
Steve MacLean	_____
Chris Hadfield	_____
Bob Thirsk	_____
Dave Williams	_____
Bjarni Tryggvason	_____
Julie Payette	_____
Drew Feustel	_____

SECTION 4

THE CANADIAN CONTRIBUTION TO AIRCRAFT DEVELOPMENT

Aircraft development depended on OEMs for Canadian design and built aerospace and defence products for airlines, such as Boeing, Airbus, Lockheed Martin and Raytheon. The Canadian industry has had a close relationship with the US market.



Did you know?

US airlines have been a major purchaser of Canadian regional jets.

The Defence Development Sharing Arrangement Sharing Agreement allowed Canadian firms to take on cost-shared Research & Development (R&D) for the US Department of Defense requirements. This allowed Canada access to the latest technology and to initiate next-generation services for aircraft, including:

- Airbus's A-380, and
- Boeing's Sonic Cruiser.

Canadian universities and colleges provide internationally recognized programs to train:

- aerospace engineers,
- aerospace manufacturing engineers,
- aviation technicians, and
- aircraft maintenance engineers.

The Canadian Aviation Maintenance Council (CAMC) plays a role in the development of curricula and accreditation programs for universities and colleges for the aerospace maintenance sector.

The Canadian Commercial Corporation (CCC) works as Canada's international contracting agency. The CCC negotiates and executes bilateral government-to-government contracts. The CCC provides the assurance of transparency at every phase of the procurement process.

Technology Partnerships Canada (TPC) funds technology development for individual projects on a case-to-case basis. Canada's participation in the Joint Strike Fighter (JSF) program is the result of TPC funding to Canadian aerospace companies. Supplies, evaluation sites and system development by Canadian companies contribute to the development of the JSF.

Involvement in the development and manufacturing of aircraft is an ongoing part of the Canadian aircraft industry. Companies such as Goodrich and CAE have won contracts as suppliers for aircraft production, such as the A-380 program.

Canadian industry is integrated with the US and Canadian firms play a part in the global supply chain. In 2008, over 70 % of Canadian aerospace and defence output was exported to the US.



Activate Your Brain #4:

Who do these acronyms represent?

OEM	_____
R&D	_____
CAMC	_____
CCC	_____
TPC	_____

CONCLUSION

Canada has been a country with strong ties to the aerospace and aircraft industries. From the first astronomical observatory to today's JSF and ISS participation, aerospace development continues to grow.

Each Canadian has their own ideas regarding to the continued support of aircraft development, manned and unmanned space programs and future Canadian interests in space travel. The accomplishments by individuals, like Dr. Chapman, George Klein and others have aided other countries in their quest for space travel.



Congratulations, you have completed your self-study package on EO (Reflect on Canada's Contribution to Aerospace Technology). Complete the following exercise and hand the completed package to the Training Officer / Proficiency Level Officer who will record your completion in your Proficiency Level Five logbook.

FINAL EXERCISE

The Canadian aerospace and aircraft development up to the mid 1960s showed the accomplishments Canadian scientists achieved. When the CF-105 Avro Arrow and Astra and Sparrow contracts were cancelled, history has recorded the changes in how Canadian contributions were made to both space and aircraft technology.

Reflect on the information presented in this self-study package and write your thoughts on how the cancellation of the Arrow program aided the achievements of Canadian, US, Russian and other countries.

Consider the following questions:

- Do you think the Canadian aerospace program would be different if the Arrow program was completed?
- Do you think accomplishments of the former Avro Canada Limited personnel made a significant contribution to the aerospace industry?
- Do you think Canadians played a significant role in the manned space program?
- Do you think Canadian industries and individuals played a significant role in aircraft development?

THIS PAGE INTENTIONALLY LEFT BLANK

ANSWER KEY



Activate Your Brain #1:

Name the importance for each of the following:

<u>University of Toronto</u>	<u>1st recognized Department of Astronomy</u>
<u>Dr John Chapman</u>	<u>Lead development of Alouette</u>
<u>George Klein</u>	<u>STEM</u>
<u>A. V. Roe Canada Ltd</u>	<u>CF-105 Avro Arrow</u>



Activate Your Brain #2:

Who were we?

<u>SPAR</u>	<u>Special Projects A.V. Roe</u>
<u>Magellan Aerospace Group</u>	<u>Orenda Engine</u>
<u>SIFCO Industries, Incorporated (Inc.)</u>	<u>Canadian Steel Improvement, Ltd.</u>



Activate Your Brain #3:

When did they go into space?

<u>Marc Garneau</u>	<u>1984, 1996, and 2000</u>
<u>Roberta Bondar</u>	<u>1992</u>
<u>Steve MacLean</u>	<u>1992, 2006</u>
<u>Chris Hadfield</u>	<u>1995, 2001</u>
<u>Bob Thirsk</u>	<u>1996, 2009</u>
<u>Dave Williams</u>	<u>1998, 2007</u>
<u>Bjarni Tryggvason</u>	<u>1997</u>
<u>Julie Payette</u>	<u>1999, 2009</u>
<u>Drew Feustel</u>	<u>2009</u>



Activate Your Brain #4:

Who do these acronyms represent?

<u>OEM</u>	<u>Original equipment manufacturers</u>
<u>R&D</u>	<u>Research & Development</u>
<u>CAMC</u>	<u>Canadian Aviation Maintenance Council</u>
<u>CCC</u>	<u>Canadian Commercial Corporation</u>
<u>TPC</u>	<u>Technology Partnership Canada</u>

THIS PAGE INTENTIONALLY LEFT BLANK



ROYAL CANADIAN AIR CADETS
PROFICIENCY LEVEL FIVE
INSTRUCTIONAL GUIDE



SECTION 1

EO C560.01 – EXAMINE ASPECTS OF FLIGHT SAFETY (FS)

Total Time:	90 min
-------------	--------

PREPARATION

PRE-LESSON INSTRUCTIONS

Resources needed for the delivery of this lesson are listed in the lesson specification located in A-CR-CCP-805/PG-001, *Proficiency Level Five Qualification Standard and Plan*, Chapter 4. Specific uses for said resources are identified throughout the self-study package within the section for which they are required.

Review the self-study package located at Attachment A and become familiar with the material prior to facilitating this lesson.

Self-study packages are intended to be completed by the cadet independently. More information about self-study packages can be found in the foreword and preface.

Photocopy the self-study package for each cadet.

Photocopy the answer key located at Attachment B but **do not** provide it to the cadets.

PRE-LESSON ASSIGNMENT

Nil.

APPROACH

A self study was chosen for this lesson as it allows the cadet to examine FS at their own learning pace. This encourages the cadet to become more self-reliant and independent by focusing on their own learning instead of learning directed by the instructor.

INTRODUCTION

REVIEW

Nil.

OBJECTIVES

By the end of this lesson the cadet shall have examined aspects of FS.

IMPORTANCE

It is important for cadets to examine aspects of FS as each cadet, while participating in the Air Cadet Flying Program, must be aware of safety on the flight line. It is important that cadets understand the roles and responsibilities of the Flight Safety Officer (FSO) and how each individual can contribute to the safety of this program.

SELF-STUDY PACKAGE INSTRUCTIONS

OBJECTIVE

The objective of this self-study package is to have the cadet examine aspects of FS.

RESOURCES

- Self-study package, and
- Pen / pencil.

ACTIVITY LAYOUT

Provide the cadet with a classroom or training area suitable to complete the self-study package.

ACTIVITY INSTRUCTIONS

1. Provide the cadet with a copy of the self-study package located at Attachment A and a pen / pencil.
2. Allow the cadet 90 minutes to complete the self-study package.
3. Provide assistance as required to the cadet.
4. Collect the self-study package once the cadet has finished.
5. Correct the self-study package with the self-study package answer key located at Attachment B.
6. Provide feedback to the cadet and indicate whether or not they have completed the Enabling Objective (EO).
7. Return the completed self-study package to the cadet for their future reference.
8. Upon completion of the self-study package, record the result in the cadet's logbook and Cadet Training Record.

SAFETY

Nil.

END OF LESSON CONFIRMATION

The cadet's participation in examining aspects of flight safety will serve as the confirmation of this lesson.

CONCLUSION

HOMEWORK / READING / PRACTICE

Nil.

METHOD OF EVALUATION

Nil.

CLOSING STATEMENT

The cadets' awareness on how the Air Cadet Program is an active participant in the FS Program and how the FSO plays a key role to ensure the safety of all individuals and resources, supports the understanding that FS is the concern for all participants in the Air Cadet Gliding and Powered Flight Programs.

INSTRUCTOR NOTES / REMARKS

Nil.

REFERENCES

A0-045 A-GA-135-01/AA-001 Directorate of Flight Safety. (2002). *Flight safety for the Canadian Forces*. Ottawa, ON: Department of National Defence.

A3-189 Directorate of Flight Safety. (2007). *The flight safety program*. Retrieved November 19, 2009, from <http://www.airforce.forces.gc.ca/dfs-dsv/program-programme-eng.asp>

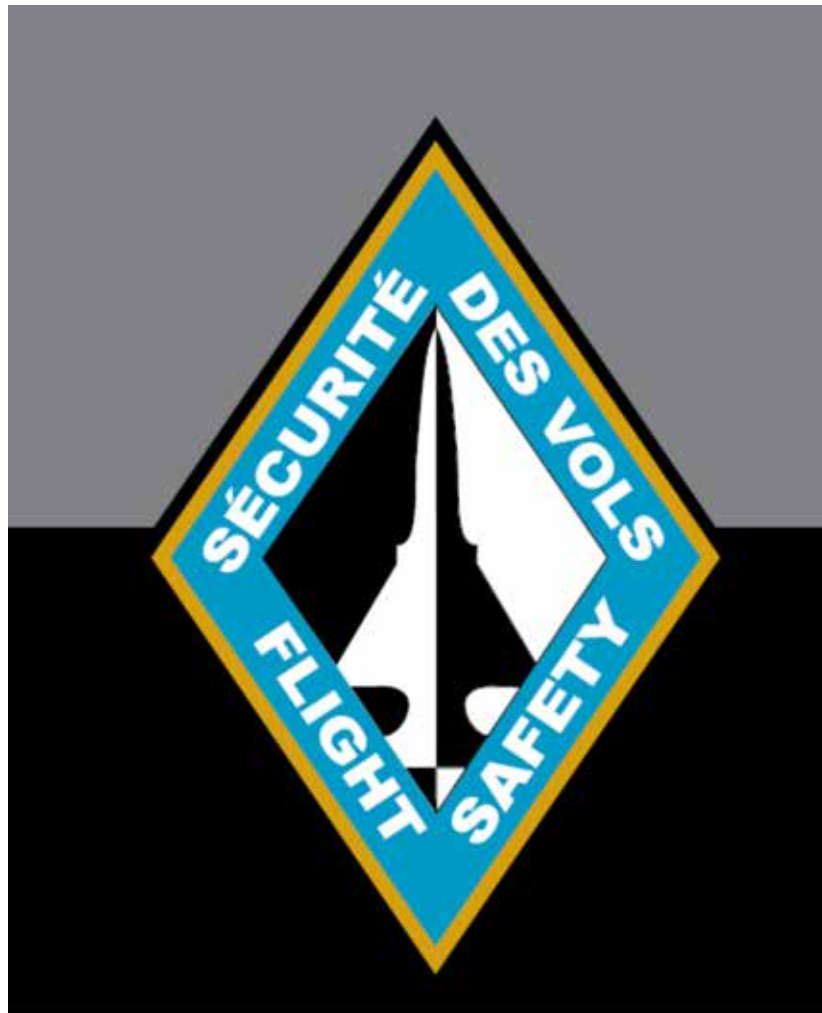

EXAMINE ASPECTS OF FLIGHT SAFETY (FS)

SECTION 1: THE ROLE OF THE FLIGHT SAFETY OFFICER (FSO) IN THE AIR CADET FLYING PROGRAM

SECTION 2: EDUCATION AND TRAINING

SECTION 3: THE REPORTING PROCESS

SECTION 4: INVESTIGATION PROCEDURES

SECTION 1
THE ROLE OF THE FLIGHT SAFETY OFFICER (FSO) IN THE AIR CADET FLYING PROGRAM



Did you know?

The first known formal recognition of the need for a dedicated FS organization occurred in mid 1942 when the Royal Canadian Air Force (RCAF) Aircraft Accident Investigation Board (AIB) was formed. The Directorate of Flight Safety (DFS) was established in the early 1950s.

FS for the Air Cadet Flying Program is the responsibility of the Canadian Forces (CF). The Chief of Defence Staff (CDS) is tasked with operational command and control of the Air Cadet Flying Program, which includes:

- Air Cadet Gliding Program,
- Air Cadet Powered Flight Program, and
- familiarization flying funded by the Department of National Defence (DND) / CF and the FS Program.

The Chief of the Air Staff (CAS) has been designated as the Airworthiness Authority (AA) for the DND / CF and is responsible for FS policy.

Designated wings act as FS advisors to the Region Comd and assist the Air Cadet Glider Program activities with the program FSO to include:

- advising on FS matters;
- monitoring the safety aspects of flying operations;
- assisting in preparation and timely submission of initial and supplementary occurrence reports and recommending preventative measures (PMs);
- conducting biannual FS surveys of all designated gliding sites;
- assisting the Director of Flight Safety (DFS) and Regional Cadet Air Operations Officer (RCA Ops O) in the event of an accident;
- assisting the Region Comd in preparing comments for FS investigation reports; and
- reviewing Air Cadet Glider Program occurrence reports for quality assurance.



Regions and designated FSOs include:

<u>REGION</u>	<u>REGION COMD</u>	<u>DESIGNATED FSO</u>
Atlantic	Comd Maritime Forces Atlantic (MARLANT)	14 Wing Greenwood
Eastern	Comd Land Forces Quebec Area (LFQA)	3 Wing Bagotville
Central	Comd Land Forces Central Area (LFCA)	8 Wing Trenton
Prairie	Comd 1 Cdn Air Div	17 Wing Winnipeg
Pacific	Comd Maritime Pacific (MARPAAC)	19 Wing Comox



An occurrence is defined as an event involving the operation of an aircraft or support of flying that constitutes an accident or incident.

An occurrence category is an alphabetical designation assigning an overall seriousness classification including:

- aircraft damage level (ADL); or
- personnel casualty level (PCL).

An FSO is designated annually by the RCA Ops O for all regional gliding schools (RGS) and gliding centres. FS qualified personnel wear the FS Diamond Badge on their operational clothing.



The aim of the FS program is to prevent the accidental loss of aviation resources. What is an aviation resource? Basically, anything or anyone involved in or supporting aviation operations.

- planes,
- parts, and
- people.

That can even include such things as the fuellers for the aircraft along with the base kitchen who makes the aircrew's box lunch!

The FS Program is based on four fundamental principles:

- Cause factors are assigned to occurrences, only done to assist the development of effective PMs .
- Personnel involved in conducting and supporting flying operations are expected to freely and openly report all FS occurrences and concerns.
- Determine the cause of occurrences so appropriate, effective PMs can be developed and implemented, personnel involved in conducting and supporting flying operations are expected to voluntarily acknowledge their own errors and omissions.
- Facilitate free and open reporting and voluntary acknowledgement of errors and omissions, the FS Program does not assign blame. Personnel involved in a FS occurrence are not identified in the final reports and the reports cannot be used for legal, administrative, disciplinary or other proceedings.



Did you know?

Before 1963, a Board of Inquiry (BOI) was required to assign blame and recommended punishment for those responsible for an accident. Between 1963 and 1965, this was changed so that information given to an aircraft accident investigation could not be used in disciplinary proceedings.

The FS Program is based on three pillars:

- education,
- analysis, and
- prevention.



Where have you seen an FSO? _____

How do you identify the FSO? _____

All flying aspects for the RGSS and gliding familiarization sites in the Air Cadet Program fall within the responsibilities of an FSO.



The duties and responsibilities of the FSO are outlined in A-GA-135-001/AA-001, *Flight Safety for the Canadian Forces*.

The FSO must be familiar with the unit's operations so that sound advice can be provided on accident prevention and hazardous conditions.



FSO responsibilities are:

- to advise the school / site comd on all aspects of FS,
- to report all accidents and incidents in accordance with A-GA-135-001/AA-001 *Flight Safety for the Canadian Forces*,
- to aid school / site comd in the implementation of the unit FS Program, and
- to monitor all aspects of the operation and advise school / site comds of hazardous conditions.

FS personnel must immediately notify the site comd of any unsafe procedures / practices detected. The site comd immediately rectifies the situation and advises the RCA Ops O of the corrective action proposed / implemented.



Activate Your Brain #1:

FS occurrence is defined as an event _____



An accident / incident are defined as:

AIR ACCIDENT

An event involving an aircraft between the time the first power plant is attempted with intent for flight and the time the last power plant or rotor stops, (a glider from the time the hook-up is completed until the glider comes to rest after landing), in which one or more of the following occurs:

- someone is missing or receives fatal, very serious or serious injuries, as determined by a medical officer (MO), contributed by an aircraft or its equipment; or
- an aircraft is destroyed, missing or sustains very serious or serious damages.

AIR INCIDENT

An event involving an aircraft between the time the first power plant is attempted with intent for flight and the time the last power plant or rotor stops, (a glider from the time the hook-up is completed until the glider comes to rest after landing), in which one or more of the following occurs:

- someone receives minor injuries, as determined by a MO, contributed by an aircraft, its equipment, or its operation;
- an aircraft sustains very minor damages; or
- there is no injury or damage but accident potential did exist.

GROUND ACCIDENT

An event involving an aircraft when there is no intent for flight, or when there is intent for flight but no power plant start is attempted, or after the power plant and rotors have stopped, in which one or more of the following occurs:

- a person is missing or receives fatal, very serious or serious injury or illness as determined by a MO and where the aircraft equipment or its operation has contributed to the event; or
- an aircraft is destroyed, missing or has sustained very serious or serious damage.

GROUND INCIDENT

An event involving an aircraft when there is no intent for flight, or when there is intent for flight but no power plant start is attempted, or after the power plant and rotors have stopped, in which one or more of the following occurs:

- a person receives minor or no injuries as determined by a MO, or there is a risk of injury or illness and where the aircraft equipment or its operation has contributed to the event;
- an aircraft receives minor damage;
- there is no damage but accident potential existed;
- there is jettison or accidental release; or
- there is damage to civilian or military property.

SECTION 2 EDUCATION AND TRAINING



Education and training not only is a fundamental element of the FS Program but also requires the FSO to be properly qualified.

Flight safety education is fundamental to accident / incident prevention. All personnel involved with flight operations should be aware of flight safety objectives. FS training and education are provided both through formal and informal means.



Activate Your Brain #2:

Where have you seen FS education and training?

_____	_____
_____	_____
_____	_____
_____	_____

All personnel active in the FS Program shall continue to educate themselves by accessing informal information from both military and civilian organizations. Material and information is available from numerous sources, including:

- FS publications,
- bulletins,
- web-based material,
- magazines (eg. *Flight Comment*),
- posters,
- FS reports (Occurrence report / *Epilogue* [EPI]),
- FS briefings,
- conferences, and
- seminars.



A more experienced FSO can educate newer, less experienced personnel by passing on knowledge learned through experience or from other leaders.

To work as an FSO, formal qualifications are obtained by completion of the CF flight safety courses, including:

- Basic FS Course (BFSC), and
- Advanced FS Course (AFSC).

The BFSC teaches candidates to:

- develop and implement an effective FS prevention and education program; and
- respond to FS occurrences, to include:
 - reporting;
 - investigating; and
 - implementing preventative measures.

The AFSC teaches candidates to:

- develop and implement an effective wing-level FS prevention and education program, and
- respond to FS occurrences, to include:
 - reporting;
 - investigating; and
 - implementing preventative measures.

The investigator's qualification is a requirement of the CF Airworthiness Program. Formal training includes:

- Basic Investigator (BI 2 and BI 3), and
- Investigator-In-Charge (IIC 1, IIC 2 AND IIC 3).

Training involves all personnel active in the Air Cadet Flying Program. To accomplish this, the FS Program uses:

- FSO formal / informal briefings,
- CF FS publications, and
- awards.



Have you attended a FS briefing? Has an FSO spoke to your group before the squadron started the familiarization (famil) flights at the gliding centre?



It is the responsibility of FS personnel at all levels to advise their comds when they have concerns with respect to FS issues. This advise can take many forms, including:

- formal / informal briefings,
- briefing notes,
- safety committee meetings, or
- informal discussions.

Briefings

FSOs are to provide / conduct briefings on information relevant to the audience which are:

- informative,
- current, and
- interesting.



Did you know?

With young cadets waiting for their first famil flight in a glider, safety is not on their mind. A briefing provides information for these cadets on expected behaviour around the glider, runway and even what to do if they see something questionable.

FS Publications

Magazines and articles are produced and distributed within the CF. *Flight Comment* is the CF FS magazine. It provides relevant, interesting and timely FS information using posters, articles and other training methods.

Within the magazine, numerous articles are presented including:

- Dossiers,
- *Epilogue*,
- From the Investigator, and
- *Lessons Learned*.

Other publications produced by the DFS include:

- *On Target* (single subject of interest),
- *FS Newsletter*, and
- *FS Flash*.



Did you know?

Within the cadet world, newsletters are published by the RGS FSO (RGS-C has an online newsletter called *Fly Right*).

Challenging activities such as crossword and word search puzzles are part of the magazine publications. To learn about FS issues and terminology, complete the following word search puzzle.

Flight Safety Word Search

By: Captain JJP Commodore

Hint 7 Letters "QUESTIONABLE DECISION"

F	T	C	I	D	E	R	P	E	T	I	T	I	O	N	F
P	A	T	T	E	R	N	E	E	N	P	F	D	N	O	P
A	L	T	E	R	R	O	R	N	E	N	I	L	C	O	D
N	E	L	I	G	H	T	F	D	M	L	H	U	M	A	N
O	R	N	I	G	H	T	O	E	E	T	S	F	E	V	T
I	T	A	M	R	U	R	R	D	R	C	S	R	C	I	C
S	N	I	P	A	E	E	M	N	I	A	E	E	H	A	E
R	E	D	I	V	N	F	A	A	U	R	Y	W	A	T	T
O	S	A	O	E	O	F	N	H	Q	T	K	O	N	I	E
T	S	C	U	L	I	E	C	T	E	X	C	P	I	O	D
A	E	R	S	N	T	C	E	F	R	E	A	T	C	N	A
R	A	I	A	H	A	T	A	E	D	E	R	I	V	E	R
E	T	C	G	O	E	S	C	L	O	C	K	U	R	I	G
P	S	I	N	U	R	G	E	N	T	A	C	T	G	Y	E
O	L	D	E	R	C	N	O	I	T	P	U	R	S	I	D
F	O	L	D	S	M	O	D	U	L	A	T	O	R	G	F

AIRY
 ALERTNESS
 ALTER
 AVIATION
 CIRCADIAN
 CLOCK
 CREATION
 DEGRADE
 DERIVE
 DETECT
 DISRUPTION

EFFECTS
 ERROR
 EXTRACT
 FATIGUE
 FIGURE
 FLIGHT
 FOCUS
 FOLD
 GRAVEL
 HOURS
 HUMAN

IMPIOUS
 LEFTHANDED
 LIGHT
 LINEN
 MECHANIC
 MODULATOR
 NIGHT
 OLDER
 OPERATORS

PATTERN
 PERFORMANCE
 PETITION
 POND
 POWERFUL
 PREDICT
 RACK
 RECOVER
 REQUIREMENT
 REREAD

SAFETY
 SCAN
 SEATS
 SHIFT
 SLEEP
 TACT
 TORSION
 URGENT

Figure A-1 Flight Safety Word Search

Note. From "Flight Comment", 2003, *Flight Safety Word Search*. Retrieved November 23, 2009, from <http://www.airforce.forces.gc.ca/dfs/publications/fc/archive/2000-2004/archive-eng.asp>



Activate Your Brain #3:

As part of FS informal education / training, list some of the information you think an FSO would present in a briefing?

_____	_____
_____	_____
_____	_____
_____	_____

Awards

Flight Comment magazine recognizes staff for accomplishments, including:

- Good Show Award for Excellence in FS, and
- For Professionalism Awards in FS.



Did you know?

Cadet Instructor Cadre (CIC) officers have been recognized in *Flight Comment*. Check out issues: Summer 2002, Summer 2005 and Issue 1 2009.



For more information and to read about some of these CIC officers, go online to <http://www.airforce.forces.gc.ca/dfs/publications/fc/fc-pdv-eng.asp>.

SECTION 3 THE REPORTING PROCESS



FS reports refer to all reports, whether oral or written.

Specific forms must be used to support the FS Program. It is critical that all occurrences are reported as potential or actual compromise of FS. Reports allow the emerging trends to be identified and analyzed.



Did you know?

On February 1, 1968, the unification of the Canadian military brought the Navy, Army and Air Force together to be known as the CF. Occurrences were addressed to the DFS. In 1975, Air Command was formed and assignment of responsibility was divided between the Air Command FS staff and DFS.

In August 2011, the Government of Canada restored the historic naming of Canada's Air Force such that it is now known again as the Royal Canadian Air Force.

There are two categories of forms designed for the FS Program: FS specific and FS related forms.

FS specific forms include:

- CF 215 Flight Safety Occurrence and Birdstrike Report (www.airforce.forces.gc.ca/dfs/publications/docs/cf215.pdf)
- DND 2484 Flight Safety Hazard Report (www.airforce.forces.gc.ca/dfs/publications/docs/fshr-rvsd)

FS related forms include:

- Report on Injuries or Immediate Death Form (form used to report serious or very serious injuries and fatalities),
- Coroner's report, and
- Unsatisfactory Condition Report.



All forms and reports must be completed in a specific format.



FS occurrences are reported if any of the following questions are answered with a yes.

1. Was there an injury or illness to personnel engaged in or supporting air operations, damage to a CF-owned aircraft or aircraft operated by or on behalf of DND / CF or damage to CF equipment used to support air operations?
2. Was there potential for injury or illness or damage to an aircraft?
3. Could reporting the FS event generate a PM that may prevent a similar occurrence?

To report an immediate flight safety hazard or accident call 1-888-WARN-DFS (1-888-927-6337).



Did you know?

The unit of ownership is the unit having control and authority over the aircraft. For ground occurrences, the unit of ownership is the unit, wing or base to which the aircraft is assigned.

There are exceptions for aircraft that include:

- aircraft undergoing depot-level maintenance at a contractor's plant,
- new aircraft being produced for the CF, and
- other non-CF aircraft.

If an accident occurs, the unit of ownership is to be notified by the fastest possible means. The reporting individual briefs the duty officer and confirms details as known.



Did you know?

Damage is defined as physical harm to an aircraft that impairs the value or normal function of the aircraft or portion of the aircraft, which includes:

- loss,
- repair, or
- replacement.

Damage is a result of unusual forces including:

- collision,
- impact,
- explosion,
- fire,
- rupture, or
- overstress.



You are pushing the glider off the runway and you notice a nut lying on the ground beside the glider. What do you do? To whom do you speak?



Activate Your Brain #4:

What must personnel at all levels report?

SECTION 4 INVESTIGATION PROCEDURES



Did you know?

Air Command FS staff manage the day-to-day FS Programs and DFS is responsible for accident collection and analysis.



If equipment has not been misused or subjected to unusual stress failures, it shall not be classed as damage, but as normal wear resulting from prolonged service use.

Occurrences are investigated quickly with the objective to prevent or reduce the risk of similar occurrences.



FS occurrences can result in or have the potential to cause a loss of resources.

FS Investigation (FSI)

A FSI refers to any investigation conducted under the terms of A-GA-135-001/AA-001, *Flight Safety for the Canadian Forces*.

DFS Investigator-In-Charge (IIC)

The IIC is appointed by the DFS and reports all aspects of the investigation and coordinates all activities of personnel on the team.

FS Investigation Report (FSIR)

The FSIR is produced to support Class I or most Class II FSI.



Did you know?

Class I to IV is based on the following criteria:

- a. the occurrence category,
- b. the safety of flight compromise level, and
- c. other factors which could impact on the reputation of the FS Program, CF and the department.

Initial Report (IR)

An IR describes the immediately available particulars of the occurrence and must be sent within 12 hours of the event.

Supplementary Report (SR)

An SR is the report normally produced by the wing or unit for aircraft incidents of category D and E. It shall be submitted within 30 calendar days of the occurrence.

Occurrence categories are classified as:		
Aircraft Damage Level (ADL)	Personnel Casualty Level (PCL)	Occurrence Category
Destroyed or missing	Fatal injury or missing	A
Very serious damage	Very serious injury / illness	B
Serious damage	Serious injury / illness	C
Minor damage	Minor injury / illness	D
Nil	Nil	E

Combined Report (CR)

A CR is the combination of the IR and SR in a single report submitted for minor occurrences requiring a limited or a brief investigation and is provided within 48 hours of the occurrence. The report is the same as the SR.

Investigations are conducted by the following:

- DFS conducts Class I and II investigations,
- a specific FSO is tasked by DFS to conduct any Class III Enhanced Supplementary FSIR (ESR), and
- a unit FSO conducts all other FSIs and the report is released to the supporting wing FSO.

The purpose of FSIs is to prevent future accidents. Determining cause factors are a means to identify problems and assists in trend analysis.

Specific cause factors results in a more exhaustive analysis of the occurrence. In turn, measures are formulated that prevents a recurrence of the problem. Cause factors assist in understanding all of the reasons why an accident or incident occurred. Cause factors should lead to PMs.

Standard terminology is used in all reports. Cause factors are any event, condition or circumstance whose presence or absence, within reason, increases the likelihood of a FS occurrence. Cause factors are listed in the following six categories:

- personnel,
- material,
- environment,
- operational,
- unidentified foreign object damage (FOD), and
- undetermined.



Did you know?

On January 1, 2004, the CF adopted the Human Factors Analysis and Classification System (HFACS) to assess and document personnel cause factors (PCF). Active failures and latent conditions need to be identified for all occurrences so that effective PMs can be implemented to reduce future occurrences.



Active failures are either the error(s) or the conscious deviation(s) from an authorized procedure that directly contribute to a FS occurrence.

Latent conditions are situations or circumstances associated with the individual(s) or the system of management (supervision) of the individual(s) involved in the occurrence.

FSIs investigate and classify failures associated with personnel to include:

- unsafe acts or conditions (active failure),
- preconditions for unsafe acts (latent - direct),
- supervision (latent - remote), and
- organizational influences (latent - remote).



Did you know?

Television shows such as The Discovery Channel show "Mayday", are created to show the FS investigation and reporting process.

Read the following FSIR to understand the format of and information within a report.

**CANADIAN FORCES
FLIGHT SAFETY INVESTIGATION (FSI) REPORT (FSIR)
SUPPLEMENTAL REPORT (SR)**

FILE NUMBER: 1010-CGBZG (DFS 2-4-2)
DATE OF REPORT: 16 FEB 04

AIRCRAFT TYPE: Schweizer 2-33A
DATE/TIME: 27 1807Z/1503 Local Sep 03
LOCATION: Summerside, PEI
CATEGORY: "B" Category Accident

This report was produced under authority of the Minister of National Defence (MND) pursuant to Section 4.2 of the Aeronautics Act (AA), and in accordance with A-GA-135-001/AA-001, Flight Safety for the Canadian Forces.

With the exception of Part 1 – Factual Information and when provided for by law, the contents of this report shall only be used for the purpose of accident prevention and are to be seen only by those with a need-to-know in the exercise of their formal functions. In any event, this report shall not be released to the public in whole or in part except under the authority of the Director of Flight Safety, National Defence Headquarters.

Due to the nature of the accident, the Supplemental Report was chosen as the reporting format. As no clear format for this report is outlined within the A-GA-135-001/AA-001, DFS is in the process of aligning all SR reports to reflect ICAO Annex 12 standardization.

1. DESCRIPTION

The auto tow launch began normally and, after the "all out" signal was given, the glider was observed to accelerate slowly. The visiting cadet assigned to signal the tow driver of the glider's progress noticed that the ground run of the glider was unusually long. Using a signal bat, the signal cadet subsequently gave the "stop, stop, stop" signal to the tow driver. As the stop signal was given, the glider became airborne and climbed to approximately 50 feet AGL. Thinking that the glider could successfully take off, the signal cadet then brought the signal bat down but the tow vehicle had already initiated a launch abort. Seeing this, the signal cadet then raised the signal bat straight up again, re-affirming the take off abort signal.

The glider was observed to descend rapidly and land hard in a level attitude approximately 2000' from the runway threshold. Ground roll was minimal and both the pilot and passenger immediately exited the aircraft unassisted. The glider suffered "C" category damage to the main wheel axle and support tubing.

2. INVESTIGATION NARRATIVE

The glider was being flown in support of the Air Cadet Fall Glider Familiarization Program from runway 24 at Summerside Airport, PEI. The accident flight was the 45th of the day. The Instructor Pilot (IP) was tasked to give a public relations flight to a civilian passenger; the IP was seated in the rear seat with the passenger in the front seat. The weather conditions at the time of accident were VFR with wind 180°/10 kts, visibility 15 SM, temperature 23°C, and sky clear.

The investigation revealed that the auto tow vehicle in use was not fully serviceable. The required rapid acceleration of the tow vehicle at the initial part of the auto tow launch would cause the vehicle to hesitate or sputter. To compensate for this and avoid stalling the vehicle, the auto tow driver would accelerate slowly. The tow driver thought this to be acceptable in the interest of keeping the operation going. The auto launch observer was reported as stating that the "truck was having problems all day." The site supervisor, pilot, and launch personnel were aware of this problem.

After having experienced similar slow accelerations during previous launches, the IP again noted the poor acceleration during the accident takeoff. After lift off, the IP observed the airspeed to be 50 MPH, but it soon decayed to 45 MPH at which point she released the towrope. The minimum allowable airspeed on auto tow is 50 MPH. The IP believed that she was "a little late" in reacting to the decaying airspeed. She attempted to lower the nose in order to regain a positive flying attitude and adequate airspeed for the round out but she was hesitant to use excessive forward stick pressure due to the close proximity to the ground. The glider descended rapidly and rounded out at approximately three to five feet without regaining the minimum approach speed of 50 MPH and with insufficient airspeed to arrest the descent during the flare.

At all Atlantic Region gliding sites, visiting cadets are encouraged to participate in the launching of the glider. They are given basic instruction and are closely monitored by the Air Cadet staff. The visiting cadet assigned to signals had little previous experience in his function. He stated that all of the launches that day were slow initially with long ground runs but that the accident flight ground run was longer by comparison. This caused him to doubt the safety of continuing the launch and, subsequently, he gave the stop signal. Upon seeing the glider go airborne, he doubted his decision and momentarily brought the signal bat down. As the glider then released the towrope and started to descend, the signal cadet then held the signal bat straight up again.

The Site Supervisor stated that operations at the launch site were being carried out as per normal with participating cadets being closely supervised by qualified personnel. The problem with the launch vehicle was brought to his attention early in the day at which point he suspended operations and personally investigated the issue. After finding the vehicle to be satisfactory as long as "full" throttle" was

not used, the Site Supervisor allowed operations to continue. The Site Supervisor said that at no time during the day did he perceive a further problem with the truck until it was again brought to his attention after the accident.

3. CAUSE FACTORS

3.1 Personnel – Pilot – Technique, in that the pilot did not make a timely and correct reaction to the decaying or inadequate airspeed in the initial portion of the launch.

3.2 Personnel – Support Personnel – Training, in that the cadet assigned to provide launch signals did not have the required training and experience to adequately judge whether or not the safety of the launch had been jeopardized.

3.3 Personnel – Management (Regional HQ) – Training, in that the instituted policy of having cadets fill launch positions as part of their familiarization experience does not make provision for adequate training in all cases. While functions such as holding a glider's wing or tail are purely mechanical tasks, launch signalling may require a cadet to make a decision based on knowledge or experience that he or she may not possess.

3.4 Personnel – Supervision (Site Supervisor) – Judgement, in that the Site Supervisor decided to continue operations after a problem with the auto launch vehicle was brought to his attention. Although he judged the vehicle to be safe for towing, its performance reportedly continued to be less than ideal. In fact, whether or not there was a mechanical problem with the vehicle is irrelevant. The problem was at least perceived, and led to unconventional launch technique by both the auto tow driver and the pilot.

4. PREVENTATIVE MEASURES

4.1 Greater emphasis on auto tow launch aborts are to be provided within both the Atlantic Region's auto tow conversion course and Proficiency/Currency program. Completion date TBA.

4.2 A PIF has been issued in Atlantic Region suspending the use of cadets in the position of Auto Launch Signaller. Its permanency is pending a review of our training syllabus. Site Supervisors have been reminded of the importance of close supervision of all inexperienced personnel utilized on-field.

4.3 Results of the launch training syllabus review are to be forwarded to the National Air Ops O for consideration of application to all regions.

4.4 All supervisory staff in Atlantic Region will be briefed on the danger of accepting substandard equipment for use in an operational role, possibly during the Annual Program Training Conference in January 04.

4.5 This accident and the accident involving C-GCLN at Miramichi NB, 1 Sep 02, is to be examined by the upcoming Standards Working Group meeting, at CFS in Dec 03, with the goal of evaluating if sufficient supervisory and decision-making training is provided to the 55 regional gliding site commanders and their staffs. This review should be conducted within the scope of discussions held during the recent Air Cadet Flying Training Conference at 19 Wing Comox, in Oct 03.

Figure A-2 FSIR

Note. From "Flight Comment", 2007, *Canadian Forces Flight Safety Investigation (FSI) Report (FSIR)*. Retrieved November 20, 2009, from <http://www.airforce.forces.gc.ca/dfs/reports-rapports/l/pdf/fsir/cgbzg.pdf>



Activate Your Brain #5:

Analyze the FSIR and comment on the report to include:

- cause factors,
- PMs, and
- who reviews the report?

Notes:

CONCLUSION

Flight safety is the concern for all participants when participating in the Air Cadet Gliding and Power Flight Program. The FSO plays a key role to ensure the safety of all individuals and resources, not only when the flying is being conducted but also by preparing personnel through education and training to recognize dangers. The training and education required by an FSO better prepares these individuals to complete this role.

For you to understand the chain of command of the FS Program, the role and responsibilities of an FSO and the reporting mechanism, you need to understand how the ACFP is an active part of the FS Program.



Did you know?

If you have questions about the FS Program, speak with the FSO at the gliding centre and remember, each region has an FSO.





You can see the complete copy of A-GA-135-001/AA-001, *Flight Safety for the Canadian Forces* online at <http://www.airforce.forces.gc.ca/dfs/publications.manual-manuel-eng.asp>



Congratulations, you have completed your self-study package on EOC560.01 (Examine Aspects of Flight Safety). Hand the completed package to the Training Officer / Proficiency Level Officer who will record your completion in your Proficiency Level Five Logbook.

Answer Guide

	Where have you seen an FSO?	<u>gliding centre,</u>
	How do you identify the FSO?	<u>CSTC - glider scholarship</u> <u>Wears the FS Diamond Badge on their operational clothing.</u>

	Activate Your Brain #1 answer:	
	FS occurrence is defined as an event	<u>involving the operation of an aircraft or support of flying that constitutes an accident or incident.</u>

	Activate Your Brain #2 answers:	
	Where have you seen FS informal education / training?	
	<u>FS publications</u>	<u>magazines (<i>Flight Comment</i>)</u>
	<u>bulletins</u>	<u>posters</u>
	<u>web-based material</u>	<u>FS briefings - CSTC</u>
	<u>conferences</u>	<u>seminars</u>
	<u>FS reports (Occurrence report / Epilogue [EPI])</u>	<u>_____</u>

Word Search Answer

Flight Safety Word Search

By: Captain JJP Commodore

Hint 7 Letters "QUESTIONABLE DECISION"

AIRY	EFFECTS	IMPIOUS	PATTERN	SAFETY
ALERTNESS	ERROR	LEFTHANDED	PERFORMANCE	SCAN
ALTER	EXTRACT	LIGHT	PETITION	SEATS
AVIATION	FATIGUE	LINEN	POND	SHIFT
CIRCADIAN	FIGURE	MECHANIC	POWERFUL	SLEEP
CLOCK	FLIGHT	MODULATOR	PREDICT	TACT
CREATION	FOCUS	NIGHT	RACK	TORSION
DEGRADE	FOLD	OLDER	RECOVER	URGENT
DERIVE	GRAVEL	OPERATORS	REQUIREMENT	
DETECT	HOURS		REREAD	
DISRUPTION	HUMAN			

Figure B-1 Flight Safety Word Search Answer

Note. From "Flight Comment", 2003, *Flight Safety Word Search*. Retrieved November 23, 2009, from <http://www.airforce.forces.gc.ca/dfs/publications/fc/archive/2000-2004/archive-eng.asp>



Activate Your Brain #3 answer:

As part of FS informal education / training, list some of the information an FSO should present in a briefing?

- Corrective action for pilots.
- Where not to walk.
- Who to speak to if you find something dangerous on the ground.
- Types of occurrences.

- Behaviour on the airfield.
- Behaviour around the aircraft.
- Who to speak to if a problem is noticed.
-



Activate Your Brain #4 answer:

What must personnel at all levels report?

- All FS occurrences
- Applicable cause factors
- PMs



Activate Your Brain #5:

Analyze the FSIR and comment on the report to include:

- cause factors,
- PMs, and
- who reviews the report?

Notes:

Cause factors

Personnel

- **Pilot** - technique, in that the pilot did not make a timely and correct reaction to the decaying or inadequate airspeed in the initial portion of the launch.
- **Support personnel** - training in that the cadet assigned to provide launch signals did not have the required training and experience to adequately judge whether or not the safety of the launch had been jeopardized.
- **Management** (Regional Headquarter) - training in that the instituted policy of having cadets fill launch positions as part of their familiarization experience does not make provision for adequate training in all cases.
- **Supervision** (site supervisor) - judgement, in that the site supervisor decided to continue operations after a problem with the auto launch vehicle was brought to his attention.

PMs

- Greater emphasise on auto tow launch aborts are to be provided within both the Atlantic Region's Auto Tow Conversion Course and Proficiency / Currency program.
- A proficiency information folder (PIF) has been issued in Atlantic Region suspending the use of cadets in the position of Auto Launch Signaller.
- Results of the launch syllabus review are to be forwarded to the National Air Ops O for consideration of application to all regions.
- All supervisory staff in Atlantic Region will be briefed on the danger of accepting substandard equipment for use in an operational role.

Who reviews the report?

- Standards Working Group



ROYAL CANADIAN AIR CADETS
PROFICIENCY LEVEL FIVE
INSTRUCTIONAL GUIDE



SECTION 2

EO C560.02 – EXAMINE THE CANADIAN BUSH PILOT INDUSTRY

Total Time:	90 min
-------------	--------

PREPARATION

PRE-LESSON INSTRUCTIONS

Resources needed for the delivery of this lesson are listed in the lesson specification located in A-CR-CCP-805/PG-001, *Proficiency Level Five Qualification Standard and Plan*, Chapter 4. Specific uses for said resources are identified throughout the self-study package within the section for which they are required.

Self-study packages are intended to be completed by the cadet independently. More information about self-study packages can be found in the forward and preface.

Review the lesson content and become familiar with the material prior to facilitating this lesson.

Photocopy the self-study package located at Attachment A for each cadet.

Photocopy the answer key located at Attachment B but **do not** provide it to the cadets.

PRE-LESSON ASSIGNMENT

Nil.

APPROACH

A self study was chosen for this lesson as it allows the cadet to examine in greater detail the Canadian bush pilot industry at their own learning pace. This encourages the cadet to become more self-reliant and independent by focusing on their own learning instead of learning directed by the instructor.

INTRODUCTION

REVIEW

Nil.

OBJECTIVES

By the end of this lesson the cadet shall have examined the Canadian bush pilot industry.

IMPORTANCE

It is important for cadets to examine the Canadian bush pilot industry as bush flying and aircraft development was an important part of our aviation history providing transportation to remote Northern communities.

SELF-STUDY PACKAGE INSTRUCTIONS

OBJECTIVE

The objective of this self-study package is to have the cadet examine the Canadian bush pilot industry.

RESOURCES

- Self-study package, and
- Pen / pencil.

ACTIVITY LAYOUT

Provide the cadet with a classroom or training area suitable to complete the self-study package.

ACTIVITY INSTRUCTIONS

1. Provide the cadet with a copy of the self-study package located at Attachment A and a pen / pencil.
2. Allow the cadet 90 minutes to complete the self-study package.
3. Provide assistance as required to the cadet.
4. Collect the self-study package once the cadet has finished.
5. Correct the self-study package with the self-study package answer key located at Attachment B.
6. Provide feedback to the cadet and indicate whether or not they have completed the Enabling Objective (EO).
7. Return the completed self-study package to the cadet for their future reference.
8. Record the result in the cadet's logbook and Cadet Training Record.

SAFETY

Nil.

END OF LESSON CONFIRMATION

The cadet's participation in examining the Canadian bush pilot industry will serve as the confirmation of this lesson.

CONCLUSION

HOMEWORK / READING / PRACTICE

Nil.

METHOD OF EVALUATION

Nil.

CLOSING STATEMENT

The evolution of bush flying and aircraft development is an important part of our aviation history. Through the flying skills of pilots and the availability of appropriate aircraft, remote Northern communities receive food, housing supplies, medical requirements and industrial supplies.

INSTRUCTOR NOTES / REMARKS

Nil.

REFERENCES

C3-348 Ministry of Natural Resources. (2009). *History of bush flying*. Retrieved September 30, 2009, from http://www.mnr.gov.ca/en/Business/AFFM/2ColumnSubPage/STEL02_165922.html

C3-349 The Stuart Graham Papers—Chronology. (2009). *Summary of the commercial flying activities in Canada, 1919–1930*. Retrieved September 30, 2009, from http://epe.lac.gc.ca/100/200/301.ic.can_digital_collections/sgraham/chron2.htm

THIS PAGE INTENTIONALLY LEFT BLANK

The Canadian Bush Pilot Industry



SECTION 1: THE ORIGIN AND DEVELOPMENT OF BUSH FLYING

SECTION 2: AIRCRAFT FLOWN

SECTION 1 THE ORIGIN AND DEVELOPMENT OF BUSH FLYING

POST WORLD WAR 1 (WWI)



Did you know?

In Canada, the word "bush" has been used since the 19th century to describe the hostile environment beyond the clearings and settlements.

There were few registered pilots in Canada at the beginning of WWI. To avoid the hazards of trench life as a soldier, young men took to the skies as members of the British Air Service. For those men who survived wartime flying, returning to civilian life was not as interesting or exciting. These veterans of aerial combat were to become pioneers as bush pilots.



Did you know?

For pilots returning to a civilian life of flying, the main choices included:

- barnstorming,
- crop-dusting, and
- bush flying.

In the remote Canadian north, lack of roads restricted the transporting of necessities such as food, medicine and building material. With the availability of aircraft and pilots willing to fly into these remote areas, bush flying filled this transportation void.

Between 1917–18, Fairchild Aerial Surveys (of Canada) conducted the first winter bush flying. Fairchild Aerial Surveys (of Canada) flew supplies from Hudson, Ontario to Narrow Lake, Ontario for Bathurst Mines.

In 1919, the first aerial survey was completed in Labrador for the South Labrador Pulp and Paper Company, Limited (Ltd). Over 15 000 aerial photographs were taken of the timberland.

With continued development and demands for service in Northern Ontario, ex-Royal Naval Air Service (RNAS) and Royal Air Force (RAF) pilots were hired to fly war-surplus aircraft. The handful of flyers who could fly and fix their aircraft became the core of the fledgling bush flying industry. To survive in the wilderness regions, aircraft needed maintenance.

The first commercial flying started in 1919 when an organized group lead by the Laurentide Paper Company requested two aircraft from the St. Maurice Forestry Protection Association in Quebec to fly fire patrols. The Curtiss HS-2L "La Vigilane" was the first commercial aircraft to complete this duty.



Did you know?

It took 12 hours and 20 minutes over three days to fly the Curtiss HS-2L "La Vigilane" from Dartmouth, Nova Scotia to Grand-Mère on Lac à La Tortue, Quebec.

You can see the La Vigilane and read its story at the Canada Aviation Museum in Ottawa, Ontario.

During the 1919 season, 80 hours of flying time was accumulated. During the 57 flights, experiments in aerial photography for forestry purposes were completed.

The Forest Protection Association decided to withdraw from the operation. The Laurentide Paper Company entered into agreement with one of the pilots, W.R. Maxwell and together they formed Laurentide Air Service Ltd.

Passenger service and surveying was a major role of this new service. Forest fire patrols over the St. Maurice River valley in Quebec was extended to include from Lake-of-the-Woods to James Bay, both in Ontario. The Ontario Department of Lands and Forest requested a survey of forest resources in Northern Ontario.



Did you know?

The first Canadian private pilot licence, air engineer's certificate and commercial aircraft registered were issued in January 1920.

At the same time, the Canadian government approved the establishment of a Canadian Air Force.

The bush flying role continued to evolve with the development of the aircraft. Transporting personnel, patrolling for forest fires and sketching or taking aerial photograph of timber limits became a common task for the pilots.

In 1920, pilots with engineers would fly to Northern Ontario regions not accessed before. Ray Maxwell with his engineer Geordie Doan made the first flight to James Bay, flying from Remi Lake, Ontario near Kapuskasing to Moose Factory, Ontario in an H-Boat. They flew the first ambulance flight in northern Canada 11 days later. Maxwell continued to fly firsts when he made the first volume carriage of airmail in Canada.

The Ontario government promoted the continued growth of bush flying by contracting services from the few air services. Large government contracts provided flying work for detail mapping, to include:

- showing lakes,
- waterways, and
- forest types.

Other contracts required the transporting of firefighting personnel and to complete fire patrols.

Pilots started flying to the North for the thrill of flying into remote areas, but this soon changed from thrill of flying to flying for profit. The number of licensed pilots, registered aircraft and private flying companies decreased by 1924; flying hours and amount of freight carried increased.

The Canadian Air Force discontinued providing flying services that could be provided by private companies.



Activate Your Brain #1:

W.R. Maxwell played a major role with the development of bush flying. Can you name some of the first accomplishments he made?

_____	_____
_____	_____
_____	_____

Creation of the Ontario Provincial Air Service (OPAS)

The Ontario government had seen the benefits of utilizing aircraft and created the OPAS to own and operate its own fleet of aircraft. Through its development of services and the pilots who flew the aircraft, the OPAS represented the "cradle of bush flying."



Did you know?

The OPAS established its primary base of operation at Sault Ste. Marie, Ontario. Other bases of operation were established across Northern Ontario. The first fleet of aircraft consisted of 13 surplus Curtis HS-2L flying boats.

With OPAS flying, contracts decreased for Laurentide and many of the best pilots and engineers left Laurentide to the new government flying service.

Laurentide tried to counter the loss of contracts by introducing scheduled services, including:

- air service into the Quebec gold field between Angliers, Lake Fortune and Rouyn, and
- mail service to Haileybury, Ontario, Angliers, Quebec and Rouyn, Quebec.

Both services were not well received by the communities and Laurentide Air Service Ltd. terminated operations in 1925.

With the discovery of Ontario gold at Red Lake, OPAS started to fly all the men, supplies and equipment needed, to Red Lake before the winter freeze.

Competition for air services developed with Patricia Airways and Exploration Ltd. providing the first scheduled air service into the gold field at Red Lake, carrying:

- passengers,
- freight, and
- mail.



Did you know?

Patricia Airways and Exploration Ltd. was developed by Roy Maxwell, the first director of OPAS. Many of the OPAS aircrews joined Maxwell.



Activate Your Brain #2:

St. Maurice Forestry Protection Association and OPAS first used what aircraft?

Northern Air Service Ltd.

In northeastern Ontario, Northern Air Service Ltd. was formed to fill the void left by Laurentide. Supplies from the Quebec goldfields were transported by Northern Air Service Ltd.

Bush flying operations continued to rely on the surplus WWI aircraft, including:

- H-boats,
- Canuck trainers,
- Avro 504Ks, and
- other available aircraft.



Did you know?

Bush flying activity was mainly developed in Ontario and Quebec. The companies set the framework for the progression of bush flying into other Canadian provinces and territories.

Western Canada Airways (WCA)

A Winnipeg businessman, James Richardson, saw the merits and potential of aircraft to serve the remote northland of Western Canada. The base of operation was located at Hudson, Ontario. With the new company a new aircraft was introduced, the Fokker Universal with a newly developed radial, air-cooled engines and a high-wing cabin.



Did you know?

Early bush pilots and engineers often sat exposed in open-cockpit aircraft during the winter when the temperature could be 35 below zero.

Bush flying duties mainly operated in the northern Ontario and Quebec goldfields. The first major undertaking of its kind in northern Canada was for WCA to supply men, machinery and materials to the west coast of Hudson Bay at Fort Churchill, Manitoba. The airlift was completed in the winter. The successful airlift was noted in government reports.



Did you know?

In 1927, Fort Churchill, Manitoba was selected as the ocean terminus of the Hudson Bay Railroad because of the successful airlift completed by WCA.

More large contracts were given to WCA, including the transporting of men and equipment to a new mining development north of Senneterre, Quebec. WCA work proved that the north was open for operations, 12 months of the year.

At this time, aircraft development was undertaken by designers, mainly because of the development of the Pratt and Whitney radial, air-cooled engine.

With winter flying, new innovations were made to improve the operation of the Fokker which was not designed for the bush. The Elliott Brothers of Sioux Lookout, Ontario redesigned skis to replace the Fokker designed skis. The new skis improved landing on rough frozen lakes and the design was used on bush planes for many years.



Did you know?

Admiral Byrd used the Elliot Brothers skis on his aircraft for all three expeditions into the Antarctic.

Expanding to the Artic Circle

With flying a common sight in the southern bush, companies looked further north, well into the Artic Circle. Aircraft would build fuel caches in the summer, landing on the lakes with aircraft equipped with floats. Once the lakes froze, flights continued with aircraft landing using skis.

The cooperation and team work of the pilots and mechanics or air engineers kept the far north open 12 months of the year. Unreliable aircraft would leave the crew stranded on a remote lake miles from anywhere with no communications. The skills of the mechanic would make the aircraft flyable or the crew would have to make the long walk out of the bush.



Figure A-1 Fokker Universal

Note. From "Western Canada Aviation Museum", 2006, *Ghost of Charron Lake-Fokker Universal Standard Aircraft G-CAJD*. Copyright 2006 by fokkeraircraftrecovery.ca. Retrieved December 2, 2009, from <http://www.interactivestudio.ca/fokker2/history.htm>

New challenges faced the crew, especially in this cold environment. At times, a new engine had to be delivered to the crippled aircraft and changed in the field or repairs to a collapse landing gear made in hot or cold situations. The challenges of working in the sub-zero temperatures lead to innovations. To protect the pilot and engineers, an all-weather canvas nose hanger was designed with a small stove for servicing aircraft engines outdoors.



Did you know?

Starting an engine in the late 1920's was challenging. The oil was drained from the engine at the end of the day and stored in a warm building then returned to the engine in the morning. If the oil was too thick, it had to be warmed over a fire pot while another fire pot was placed under the engine to thaw it. The oil was added and if it did not start, the process was repeated until the engine started.

Flying in the Artic Circle was limited to the daylight hours. Many times the crew would spend the night in the sub-zero temperatures, starting the aircraft in the early morning darkness to maximize the daylight flying time.

Canadian Airways

Canadian Airways was formed in 1930 by uniting WCA and the Aviation Corporation of Canada. The flying interests of the Canadian Pacific Railroad (CPR) and the Canadian National Railroad (CNR) was included. Canadian Airways controlled almost all air business in Canada. With the new company was introduced the Junkers JU52.

Aircraft design continued to grow and more aircraft were developed to serve multiple roles from carrying large freight including:

- bulldozers,
- tractors,
- a complete sawmill,
- cement,
- dynamite,
- fuel oil,
- horses, and
- cows for milk.

Flying locations continued to expand, supplying freight and personnel to communities, mining sites and dam constructions sites.

Austin Air Service

Two Toronto, Ontario brothers, Jack and Chuck Austin created Capreol and Austin Air Service in 1934. The name changed to Austin Airways shortly after the opening. The aircraft were Waco cabin biplanes. The modifications the brothers introduced included a removable panel on the port side behind the cabin. This allowed the loading of a stretcher, creating Canada's first commercial air ambulance.

Mining personnel were the main clients but in 1936, the Department of Lands and Forest used many air services to aid during the large forest fire season.



Did you know?

Pilots were paid a monthly salary and a dollar a flying hour. When the dollar an hour was changed to a dollar a mile, aircraft started moving faster in shorter times.

Austin Airways established numerous Ontario bases from Sudbury, Chapleau, Gogama and Biscotasing. A summer base was established at Temagami, Ontario. Austin aircraft flew over Northern Ontario and beyond, linking remote native communities. Fish hauling was a profitable business with these communities.

By 1941, Austin Airways had expanded in Ontario, to South Porcupine and Nakina with regular flights into James Bay and soon flying on both sides of Hudson Bay.

The creation of northern airlines provided the mainstay of transporting personnel and material between southern communities to northern remote communities. The expansion of roles for these airlines changed with the development of aircraft, better suited for remote flying duties. From the larger cargo aircraft to smaller aircraft better suited to fly into smaller remote lakes, the role of the bush pilot continues to evolve to today's standards.



Did you know?

Television shows such as The Discovery Channel show "Ice Pilots", are created to show the role and hardships of pilots in northern Canada.

The bush aircraft come in various sizes and shapes but are designed to withstand the take-off and landing in short distances.

The skills of men and women include good piloting skills and a need to adapt to precise flight at slow speeds for landings and take-offs on small lakes and landing strips. Bush pilots tend to be self reliant individuals with knowledge of wilderness survival.

Today, bush flying has evolved into a new outlet, supporting new services to remote locations.

Missionaries fly in and out of remote communities to provide religious service to communities.

Bush flying has evolved into a family activity with the availability of rentals and charter tours. Small companies provide bush pilots to fly people into small remote locations to provide recreational support to many people, including:

- hunters,
- fishermen,
- photographers, and
- outdoor enthusiasts (campers and hikers).



Did you know?

Training is available to teach pilots the skills to fly and land float aircraft which has opened new locations for the owners of private aircraft. With more pilots receiving the skills to fly specially equipped aircraft, comes the dangers of inexperienced pilots flying to remote locations.

With the development of helicopters, bush flying has introduced specific helicopters to fly into remote communities not accessible by aircraft. The ability to manoeuvre a helicopter into confined spaces introduced a modern mode of transportation to provide support to more northern communities and outposts. The role of fire detection is better suited for helicopters as they can hover over tight spots, give accurate information, fly loaded detection patrols during high-hazard days or high-risk areas and land crews in specific areas.



Activate Your Brain #3:

Can you name some of the air services?

_____	_____
_____	_____
_____	_____

SECTION 2 AIRCRAFT FLOWN

Many aircraft were used to promote the bush flying role for Canadian air services. Development of bush flying specific aircraft was not a priority as many air services used the aircraft of the day. Many aircraft were float planes as most of the land planes could not land on unprepared fields and the large amount of undeveloped, forested land led to many aircraft having to land on lakes.

PIONEER BUSH FLYING AIRCRAFT

Pilots who trained on different aircraft during WWI returned to Canada and flew the war-surplus aircraft purchased for pioneering services to northern, isolated communities. The aircraft were large flying boats that required specific sized lakes and landing stripes to operate. The main base of operation was a water base suitable for the large lumbering aircraft to land and take-off.

Curtiss HS-2L

The Curtiss HS-2L flying boat was an open cockpit aircraft used for costal patrols during WWI. This aircraft was the pioneer bush flying aircraft. The single Liberty engine aircraft could land and take-off from water but had wheels for manoeuvring on land. The Canadian government first used these aircraft for anti-rum-running, fishery and custom patrols on the east and west coast before two HS-2Ls were sent to fly fire patrols for the St. Maurice Forestry Protection Association of Quebec.



Figure A-2 Curtiss HS-2L

Note. From "Défense nationale", 2004, *Curtiss HS-2L*. Retrieved December 2, 2009, from <http://www.airforce.foces.ca/v2/equip/resrc/images/hst/l-g/hs2l.jpg>

Vickers Vedette Flying Boat

The Vickers Vedette flying boat was the first aircraft built to a Canadian specification for Canadian conditions. The RCAF flew this aircraft for forestry surveying and fire protection patrols. The aircraft was flown to wilderness areas for communications and photography surveys for the preparation of maps by the Geological Survey of Canada.



Figure A-3 Vickers Vedette Flying Boat

Note. From "Government of Canada", 2004, *Canadian Military Heritage*. Retrieved December 2, 2009, from http://www.cmhg-phmc.gc.ca/cmh/en/image_587.asp

de Havilland Moth

The OPAS used the de Havilland Gypsy Moth but the RCAF used the de Havilland Cirrus Moth.



Figure A-4 de Havilland DH-60 Cirrus Moth

Note. From "National Defence", 2004, *Canada's Air Force, Aircraft, Historical Aircraft, de Havilland DH-60 Cirrus Moth*. Retrieved December 2, 2009, from <http://www.airforce.foces.ca/v2/equip/hst/moth-eng.asp>



Did you know?

The word Gypsy and Cirrus was the name of the engine design.

Curtiss JN-4 "Canuck"

The Curtiss JN-4 was used by Northern Air Service Ltd. to fly many firsts including:

- first ski flying,
- first airmail,
- first aerial survey, and
- first flight across the Canadian Rockies.



Figure A-5 Curtiss JN-4

Note. From "Canada Aviation Museum", *Curtiss JN-4 "Canuck"*—Canada Aviation Museum. Retrieved December 2, 2009, from <http://www.aviation.technomuses.ca/collections/artifacts/aircraft/CurtissJN-4Canuck>

Avro 504k

Only two of the Canadian version of the Avro 504 were built and flown by the RCAF. A civil Avro 504k was one of the first commercial passenger flights into the Canadian bush on October 15–17, 1920. Two passengers sat in the front open cockpit seat and were flown from Winnipeg to Le Pas, Manitoba.

An Avro 504k made the first winter flight to James Bay in 1922.



Figure A-6 Avro 504k G-CYFG

Note. From "Canada Aviation Museum", *Avro 504K G-CYFG—Canada Aviation Museum*. Retrieved December 2, 2009, from <http://www.aviation.technomuses.ca/collections/artifacts/aircraft/Avro504KG-CYFG>

Fokker Standard Universal

The Fokker Standard Universal was built in 1926. The fuselage and tail surfaces were made of welded tubular steel, covered with fabric. The wings were plywood with a Sitka spruce spar and the engine was the Wright J-4B 200 horse power (hp). The pilot sat in an open cockpit while the engineer travelled in the enclosed cargo section.



Figure A-7 Fokker Standard Universal

Note. From "Western Canada Aviation Museum", 2006, *Ghost of Charron Lake-Fokker Universal Standard Aircraft G-CAJD*. Copyright 2006 by fokkeraircraftrecovery.ca. Retrieved December 2, 2009, from <http://www.interactivestudio.ca/fokker2/history.htm>



Did you know?

A Fokker Stand Universal was used by Admiral Byrd for his 1928–1930 expedition to the Antarctic.

Junkers Ju-52 CF-ARM

Canadian Airways Ltd. flew the Junkers Ju-52 from the Red River. The Junkers Ju-52 was the largest single-engine aircraft operated in Canada and was fondly referred as the "Flying Boxcar". The single engine aircraft was brought to Canada from Germany and outfitted with a 830 hp Roll Royce Buzzard engine.



Figure A-8 Junker Ju 52 CF-ARM

Note. From "Western Canada Aviation Museum", 2009, *Junkers Ju-52*. Copyright 2009 by Western Canada Aviation Museum. Retrieved December 2, 2009, from <http://www.wcam.mb/junkers.html>



Did you know?

The Junkers Ju-52 lands at 47 miles per hour and appears to float toward the ground like a glider.

Waco

The Waco biplane had a cabin for both the pilot and engineer to fly protected from the environment. Up to three people can travel in this aircraft.



Figure A-9 Waco UIC

Note. From "Alberta Aviation Museum Edmonton", 2009, *Waco UIC (1933)*. Copyright 2009 by Alberta Aviation Museum. Retrieved December 2, 2009, from http://www.albertaaviationmuseum.com/index.php?option=com_content&task=view&id=31&item=41

Noorduyn Norseman

The Noorduyn Norseman is a commercial aircraft designed as a light transport. The Norseman has a Whitney R-1340 radial engine. The design of this large bush plane enabled it to remain in service from 1935–1959 when many were replaced by the de Havilland Otter.



Figure A-10 Noorduyn Norseman

Note. From "U.S. Centennial of Flight Commission", 2009, *General Aviation: Noorduyn Norseman Bush Plane*. Copyright 2009 by John Stephens. Retrieved December 2, 2009, from http://www.centennialofflight.gov/essay/GENERAL_AVIATION/bush_flying/GA18G3.htm



Did you know?

During WWII, famed band leader Glenn Miller disappeared over the English Channel. It was rumoured that he was abducted by space aliens or the Norseman, he was flying, had design flaws. Neither was true.

PRESENT BUSH FLYING AIRCRAFT

With the advancement of engine design, more powerful power plants allowed new designs to be considered for future bush flying aircraft. Large and small aircraft were built for role specific duties. Helicopter development and refinement created numerous multi-role airframes.



Did you know?

Engines were identified with lettering to include:

- opposed (O),
- radial (R),
- fuel injected (I),
- turbocharged (T or TS),
- geared (G), and
- helicopter or vertical installation (H or V).

de Havilland DHC-2 Beaver

The Beaver was designed as a no-nonsense bush plane with a nine cylinder Pratt & Whitney radial engine. The all metal aluminum, semi-monocoque design had tube frame seats and first flew in 1947. The Beaver had short take-off and landing capability (STOL) and could fly with floats or skis. It was known as a "half-ton truck with wings".



Figure A-11 de Havilland Beaver

Note. From "U.S. Centennial of Flight Commission", 2009, *General Aviation: de Havilland Beaver*. Copyright 1996 by Geoff McDonell. Retrieved December 2, 2009, from http://www.centennialofflight.gov/essay/GENERAL_AVIATION/bush_flying/GA18G3.htm

de Havilland DHC-3 Otter

The Otter first flew in 1951 and was the successor of the DHC-2 Beaver. It was initially called the "King Beaver" but was renamed the Otter. It was like the Beaver but many were converted to turbo-prop Pratt & Whitney or Walter engines.



Figure A-12 de Havilland Otter

Note. From "findtarget reference", 2009, *Seaplane Information*. Copyright 1999–2009 by FindTarget.com. Retrieved December 2, 2009, from <http://reference.findtarget.com/search/seaplane>



Did you know?

The Otter was the basis for de Havilland's successful Twin Otter.

Cessna Floatplanes

Cessna floatplanes were designed in numerous configurations, including:

- single-engine Cessna 182,
- twin-engine Cessna 337 Skymaster, and
- single-engine Cessna Caravan.

The high wing placement allowed the pilot an unobstructed view of the area below. The slow-speed requirement was met by the Cessna, allowing the pilot to observe and report accurately on a fire.



Figure A-13 Cessna 182 Floatplane

Note. From "Creek Side Landing", 2009, *Cessna 182*. Copyright 2009 by Old Planes and Cars for Sale. Retrieved December 2, 2009, from <http://www.oldplanesandcars.com/inventory>



Figure A-14 Cessna 337 Skymaster

Note. From "Canadian Bushplane Heritage Centre", 2009, *Cessna 337 Skymaster*. Retrieved December 1, 2009, from <http://www.bush-planes.com/detection-aircraft-canadian-bushplane-heritage>

Helicopters

With the introduction of helicopters to the role of bush flying, more remote areas were accessible and specific tasks were assigned to the helicopter. Helicopters could land and take off from tight spots and hover over a fire for the observer to note and report the details.

Helicopters varied in size and could fulfill various roles, to include:

- fire watch,
- firefighting,
- construction,
- lumber collection, and
- recreational hunting and fishing excursions.



Figure A-15 Helicopter

Note. From "Canadian Bushplane Heritage Centre", 2009, *Helicopter*. Retrieved December 1, 2009, from <http://www.bush-planes.com/detection-aircraft-canadian-bushplane-heritage>



Figure A-16 Bell 47 Bush Helicopter

Note. From "bush-planes.com", *Bell 47*. Retrieved December 3, 2009, from <http://www.bush-planes.com/Bell47Helicopter.htm>



Figure A-17 Bell Jet Ranger Bush Helicopter

Note. From "bush-planes.com", *Bell Jet Ranger*. Retrieved December 3, 2009, from <http://www.bush-planes.com/BellJetRangerHueyHelicopter.htm>



Figure A-18 Sky Crane Helicopter

Note. From "bush-planes.com", *Sky Crane*. Retrieved December 3, 2009, from <http://www.bush-planes.com/SkyCraneHelicopter.htm>



Figure A-19 C47 Chinook Helicopter

Note. From "bush-planes.com", *C47 Chinook*. Retrieved December 3, 2009, from <http://www.bush-planes.com/ChinookandSeaKnightHelicopters.htm>



If you visit Sault St. Marie, Ontario, you can see and learn about bush planes at the Canadian Bushplane Heritage Centre, or go to <http://bushplane.com>

Can you Identify bush aircraft?

Number the name of the aircraft with the picture of the aircraft.

1	Curtis HS-2L
2	Vickers Vedette Flying Boat
3	de Havilland DH-60 Cirrus Moth
4	Curtis JN-4
5	Avro 504k G-CYFG
6	Fokker Standard Universal
7	Junker Ju 52 CF-ARM
8	Waco UIC
9	Noorduyn Norseman
10	de Havilland Beaver
11	De Havilland Otter
12	Cessna 182 float plane
13	Cessna 337 Skymaster
14	Bell 47 bush helicopter
15	Bell Jet Ranger bush helicopter
16	Sky Crane helicopter
17	C47 Chinook helicopter

Bush aircraft	Number of name
	













CONCLUSION

The historical value of the bush pilot to open Northern Canada can be traced back to the returning pilots from WWI. Although the original reason to become a bush pilot was for the excitement of flying in the wilds of Canada, the development of the air services allowed business to expand during the times of forestry and mining.

Northern communities received the support from the flying services to provide the resources and services that would not be available if the bush aircraft had not been developed to the level of operation today.



Congratulations, you have completed your self-study package on EO C560.02 (Examine the Canadian Bush Pilot Industry). Hand your completed package to the Training Officer / Proficiency Level Officer who will record your completion in your Proficiency Level Five logbook.

ANSWER KEY



Activate Your Brain #1 answer:

W.R. Maxwell played a major role with the development of bush flying. Can you name some of the first accomplishments he made?

Formed Laurentide Air Service Ltd.
First ambulance flight to northern
Canada

First flight to James Bay from Remi Lake
First volume mail carriage of air mail in
Canada



Activate Your Brain #2 answer:

St. Maurice Forestry Protection Association and OPAS first used what aircraft?

surplus Curtis HS-2L flying boats



Activate Your Brain #3 answer:

Can you name some of the air services?

Laurentide Air Service Ltd
Ontario Provincial Air Service (OPAS)
Northern Air Service Ltd
Canadian Airways

Canadian Air Force
Patricia Airways & Exploration Ltd
Western Canada Airways (WCA)
Austin Air Service

Bush aircraft	Number of name
	5



14



15



17



12



13



1



4



10



3



11



6



7



9



16



2



8

THIS PAGE INTENTIONALLY LEFT BLANK



**ROYAL CANADIAN AIR CADETS
PROFICIENCY LEVEL FIVE
INSTRUCTIONAL GUIDE**



SECTION 1

**EO C570.01 – EXAMINE THE ASPECTS OF AIRCRAFT MANUFACTURING AND
MAINTENANCE THROUGH THE DEVELOPMENT OF AEROBATIC AIRCRAFT**

Total Time:

90 min

PREPARATION

PRE-LESSON INSTRUCTIONS

Resources needed for the delivery of this lesson are listed in the lesson specification located in A-CR-CCP-805/PG-001, *Proficiency Level Five Qualification Standard and Plan*, Chapter 4. Specific uses for said resources are identified throughout the self-study package within the section for which they are required.

Self-study packages are intended to be completed by the cadet independently. More information about self-study packages can be found in the forward and preface.

Review the lesson content and become familiar with the material prior to facilitating this lesson.

Photocopy the self-study package located at Attachment A for each cadet.

Photocopy the answer key located at Attachment B but **do not** provide it to the cadets.

PRE-LESSON ASSIGNMENT

Nil.

APPROACH

A self study was chosen for this lesson as it allows the cadet to examine in greater detail the aspects of aircraft manufacturing and maintenance through the development of aerobatic aircraft at their own learning pace. This encourages the cadet to become more self-reliant and independent by focusing on their own learning instead of learning directed by the instructor.

INTRODUCTION

REVIEW

Nil.

OBJECTIVES

By the end of this lesson the cadet shall have examined the aspects of aircraft manufacturing and maintenance through the development of aerobatic aircraft.

IMPORTANCE

It is important for cadets to examine the aspects of aircraft manufacturing and maintenance through the development of aerobatic aircraft as through the years flying skills and better aircraft development has created higher performing aircraft.

SELF-STUDY PACKAGE INSTRUCTIONS

OBJECTIVE

The objective of this self-study package is to have the cadet examine aspects of aircraft manufacturing and maintenance through the development of aerobatic aircraft.

RESOURCES

- Self-study package, and
- Pen / pencil.

ACTIVITY LAYOUT

Provide the cadet with a classroom or training area suitable to complete the self-study package.

ACTIVITY INSTRUCTIONS

1. Provide the cadet with a copy of the self-study package located at Attachment A and a pen / pencil.
2. Allow the cadet 90 minutes to complete the self-study package.
3. Provide assistance as required to the cadet.
4. Collect the self-study package once the cadet has finished.
5. Correct the self-study package with the self-study package answer key located at Attachment B.
6. Provide feedback to the cadet and indicate whether or not they have completed the Enabling Objective (EO).
7. Return the completed self-study package to the cadet for their future reference.
8. Record the result in the cadet's logbook and Cadet Training Record.

SAFETY

Nil.

END OF LESSON CONFIRMATION

The cadet's participation in examining the aspects of aircraft manufacturing and maintenance through the development of aerobatic aircraft will serve as the confirmation of this lesson.

CONCLUSION

HOMEWORK / READING / PRACTICE

Nil.

METHOD OF EVALUATION

Nil.

CLOSING STATEMENT

The development and the performance of aerobatic aircraft have resulted in numerous flying skills and better aircraft over the years. Manufacturing and maintenance from the time of the Wright brothers has created higher performing aircraft.

INSTRUCTOR NOTES / REMARKS

Nil.

REFERENCES

A3-183 Department of National Defence. (2009). *Full history*. Retrieved October 1, 2009, from <http://www.snowbirds.dnd.ca/v2/hist/hist2-eng/asp>

C3-348 Sport Pilot. (2009). *Aerobatics*. Retrieved October 1, 2009, from http://www.esparacing.com/sport_pilot.htm

C3-349 Jet Fighter School II. (2009). *Introduction to aerobatics*. Retrieved October 1, 2009, from <http://www.flightsimbooks.com/jfs2/chapter1.php>

C3-350 Model Aviation. (1999). *A short history of aerobatics*. Retrieved October 1, 2009, from <http://jmrc.tripod.com/fa/aero.aero1.htm>

C3-351 Hickok Sports.com. (2003). *Aerobatics*. Retrieved October 1, 2009, from <http://www.hickoksports.com/history.shtml>

Aspects of Aircraft Manufacturing and Maintenance Through the Development of Aerobatic Aircraft



SECTION 1: THE ORIGIN OF AEROBATIC FLIGHT

SECTION 2: AIRCRAFT DEVELOPMENT

SECTION 3: MODERN AEROBATIC DISPLAYS

SECTION 4: CANADIAN AEROBATIC TEAMS

SECTION 1 THE ORIGIN OF AEROBATIC FLIGHT

ORIGIN

Pre-World War I (WWI)



Did you know?

The first time the Wright brothers made a 360-degree banked turn, the idea of aircraft development for more thrilling control of an aircraft started.

With the development of the aircraft in 1904, each new aircraft manoeuvre was more thrilling to the public. Large paying audiences soon tired of watching pilots perform simple flying exhibits and demanded more thrills and danger. Pilots competed to develop flying tricks and stunts leading to aerobatic manoeuvres.



Did you know?

Flying clubs were created soon after the development of the aircraft. To teach new pilots how to fly and handle the numerous new aircraft being developed, clubs were created by individuals and builders such as Curtis.

In 1905, Count Henri de la Vaux, vice-president of the Aero Club of France gave a presentation to the Olympic Congress of Brussels for the formation of a universal aeronautical federation to regulate the various aviation meetings and advance the science and sport of aeronautics. The Fédération Aéronautique Internationale (FAI) was formed by countries including:

- Belgium,
- France,
- Germany,
- Great Britain,
- Italy,
- Spain,
- Switzerland, and
- The US.

Daredevils



Did you know?

A daredevil is defined as a reckless, impulsive, and irresponsible person.

In 1910, the American, Walter Brookins was performing spiral dives and 90-degree banked turns, thrilling audiences who thought such moves were wild and dangerous. Another American, Lincoln Beachey created his "Death Dip" to counter Walter Brookins flying displays and became known as "the father of aerobatic flying". He would fly to 5 000 feet and dive straight at the ground with the engine turned off, recovering at the last second, scaring the audience.



Did you know?

Walter Brookins was the first pilot trained by the Wright brothers to fly their aircraft.

Pilots like Lincoln Beachey and Walter Brookins would barnstorm the country, appearing at county fairs as stunt fliers, thrilling audiences.



Did you know?

On arrival to a town, the pilot would perform a series of loops, rolls and spins to draw a crowd to a grass field where the pilot would land. To cover a pilot's expenses, rides were offered for a fee.

The aircraft used evolved from the military aircraft but the increased stress on the control surfaces and systems caused system and structural damage. Airframes would collapse while pulling out of diving manoeuvres.



Control surfaces include:

- ailerons,
- elevators and stabilizers, and
- the rudder.

Control systems used can be:

- cables and pulleys,
- push and pull rods, or
- torque tubes.

The aircraft used were oversized and underpowered. These factors produced an uninteresting aerobatic performance, by today's standard. Aircraft maneuverability was sluggish and the ability to climb vertically was limited. Flying at slow speeds could result in the aircraft stalling and spinning. Stalls and spins were manoeuvres not understood by the early pilots until Wilfred Parke, a test pilot for the Roe Avro Company, experienced this while test piloting for the military.



Did you know?

Wilfred Parke fell into a left-hand spin after stalling and pulled hard on the stick and pushed the rudder to the left with no correction. He then eased off the rudder and pushed the rudder to the right into the spin which caused the aircraft to right.

With the spin correction mastered, pilots included this new manoeuvre in their routine.

Upside Down and Backwards Flying



Did you know?

Aerobatic flight is defined as precise manoeuvring in three dimensional space. Manoeuvring is divided into three components including:

- position,
- velocity, and
- attitude.

With the development of the monoplane and rotary engines, pilots found this design gave them better control and they started experimenting with unusual flight manoeuvres.

An Englishman, William Moorhouse, was the first pilot to fly an aircraft backward. During a steep climb with the nose up as far as it would go, he turned the engine off. The aircraft stopped momentarily then slipped backward for a short distance before yawing to the side and diving straight toward the ground. This became another thrilling manoeuvre for pilots to practice then perform.



Did you know?

Many pilots found themselves flying inverted as a result of wind gusts. No one had flown into an inverted position intentionally.

In 1913, Adolphe Pegoud was a test pilot with the Bleriot aircraft development team. He decided to create a new manoeuvre and in September 1913, he performed the first half roll to an inverted position. He first practiced in an aircraft suspended in a hanger, hanging upside down. He realized the controls would have to be operated in a reverse manner and from the upside-down position practised the feel of flying in this manner. During the first demonstration, the aircraft proved that inverted flight could not be accomplished for a long time as Pegoud was drenched in fuel.



Did you know?

Adolphe Pegoud was the first flyer to jump from an aircraft on August 13, 1913 at Chateaufort, France to test a parachute.

At the same time in 1913, Petr Nikolaevich Nesterov, a Russian air force officer, performed the first complete loop creating another aerobatic manoeuvre. Everyone started doing loops. In 1914, Beachey performed the outside (inverted) loop.



Did you know?

Petr Nikolaevich Nesterov was immediately arrested for taking undue risk with military equipment but his superiors recognized the advantage of this manoeuvre and he was released and promoted.

WWI



Did you know?

Aerobatic flying was the forerunner to air combat.

Air shows and flying exhibitions were heavily attended by the public until the start of WWI. Aerobatic tricks and stunts were skills many pilots learned to survive in battle. Superior tactics gave a pilot an edge over others even when flying an inferior aircraft.

Oswald Boelcke, a German air force pilot, was a master tactician and leader and created many tactics used successfully by German aviators. He is known as the "father of air combat".



Did you know?

The first German air ace, Max Immelmann, was a master of the surprise attack. He used aerobatic manoeuvres to attack or get away from his adversaries. The Immelmann Turn is a modern aerobatics manoeuvre where the pilot combines an ascending half loop with a half roll.

With continued development of aircraft such as the German Fokker Albatross and the English Sopwith, many pilots created new tricks for the aerobatic inventory, to include:

- half loops,
- barrel rolls, and
- the split-S.

Those pilots who could master these skills over the battlefield lived the longest and were the most successful.



Did you know?

Formal training courses for the military were not set up until 1917, three years after the start of WWI.

Pre-World War II (WWII)

Rivalry between pilots returning from the WWI battlefields of Europe continued to create new manoeuvres, including:

- vertical rolls,
- flat spins,
- vertical figure eights, and
- the avalanche (roll on the top of a loop).

Manoeuvres were created, at times when a pilot was attempting a specific manoeuvre, got into difficulty and to prevent from crashing, recovered anyway possible; creating something new for others to attempt to recreate.



Did you know?

Len Povey, a famous American barnstormer, was hired to train the new Cuban Air Force, in the early 1930s. He was persuaded to compete in Miami, Florida in a new Curtis Hawk biplane. As he was attempting to complete a triple Avalanche, three snaps at the top of a loop, he found he had too much speed for the snap. He rode over the top, coming down the back side completing a half-roll into another loop, again half rolling on the back side before pulling out.

He had created what became known as the "Cuban eight".

Air shows soon returned featuring famous barnstormer acts. Individual teams joined together to create multiple displays with ticket sellers, ground controllers and display pilots.

In 1927, the first large scale aerobatics competition was held in Zurich, Switzerland. At this time, the first aircraft fuel system capable of inverted flight appeared. Gerhard Fieseler, a German air force pilot, had an interest in inverted flight and provided the development of the new fuel system which brought inverted flight back into aerobatics.

Competitive aerobatic competition became a mature sport complete with rules and regulations.



Did you know?

With the development of motion pictures, movies were created showing the development of aviation and aerobatics. Some examples of movies you can watch, include:

- *The Lost Squadron* (1932),
- *Devil Dogs of the Air* (1935),
- *Dawn Patrol* (1938),
- *The Blue Max* (1966), and
- *The Great Waldo Pepper* (1975).

WWII and Beyond

Many of the tactics and manoeuvres effective in WWI proved obsolete and dangerous with the aircraft advancements being created during WWII. Few aerobatic manoeuvres were created during this period of global conflict but aircraft modifications made advancements for the safety of the pilots.



Did you know?

The more powerful engines created higher gravity (G) forces; positive and negative. Flight manoeuvres which impose high G factors on a pilot include:

- steep turns,
- pull-outs,
- rolls,
- tail slides, and
- inverted loops.

The physical demands on pilots in higher performing aircraft required modifications, some including:

- adding foot straps to keep the pilot's feet from slipping off the rudder peddles during manoeuvres; and
- placing a window in the floor of the cockpit to identify the plane's dive angle.

In the mid-1950s, Czechoslovakian pilots introduced the most thrilling manoeuvre of the times, a "Lomcevak".



Did you know?

A Lomcevak is the first gyroscopic manoeuvre using the gyroscopic precession generated by the propeller. Depending on the aircraft, the result is a graceful end-for-end tumble on all three control axes.

SECTION 2 AIRCRAFT DEVELOPMENT



Aerobatic aircraft designs can be ordered as a home-builder's kit. The aircraft is built by an individual and certified before being flown.

Through the years of aircraft development from the first flight by the Wright brothers to present high performance aerobatic aircraft, aircraft were adapted from conventional military trainers and sport aircraft using biplane or monoplane wing designs.



Can you picture this antique aircraft looping in the air?



Figure A-1 Little Looper

Note. From "Aerofile", 2009, *Beachey, Beachey-Curtiss*. Retrieved November 23, 2009, from http://www.aerofiles.com/_ba.html



Figure A-2 Tiger Moth

Note. From "Virtualtourist", 2009, *More Aircraft, Rare, Old or Precious*. Copyright by Virtualtourist.com, Inc, 1994–2004. Retrieved November 26, 2009, from <http://members.virtualtourist.com/m/tt/6fa74/>

Early aircraft were constructed of wood, fabric and wire; very fragile and not suited for the increased stress from the demands of the pilots with limited experience.

Early aircraft were oversized and underpowered having limited ability to climb vertically so pilots would climb to higher altitudes between manoeuvres. Many times, the contemporary aerobatic aircraft was more similar to conventional light aircraft of the day.

In the 1930s–40s, Grumman built an aircraft which could bear the high structural stresses of aerobatic flying and modified the engine to endure inverted flying for up to 30 minutes. The Grumman Gulfhawk II thrilled air show audiences from 1936–1948.



Figure A-3 Grumman Gulfhawk II

Note. From "Aerobatic Flight", 2009, *U.S. Centennial of Flight Commission*. Retrieved November 25, 2009, from http://www.centennialofflight.gov/essay/GENERAL_AVIATION/aerobatic/GA19.htm

In the mid 1930s, the German-built biplane, the Bücker Bü-133 Jungmeister became the dominant force in aerobatic competitions from the mid 1930s until the outbreak of WWII. Ailerons were added to both the upper and lower wings and the agility and responsiveness to the controls made this aircraft ideal for aerobatic flying.



Figure A-4 Bücker Bü-133 Jungmeister

Note. From "Virtualtourist", 2009, *More Aircraft, Rare, Old or Precious*. Copyright 1994–2004 by Virtualtourist.com, Inc. Retrieved November 26, 2009, from <http://members.virtualtourist.com/m/tt/6fa74/>



Did you know?

A civilian German flying club known as the "Luftsportverband" flew the Jungmeister as a training aircraft. Some of these pilots created a secret German Air Force that evolved into the Nazi Luftwaffe.

In 1945, Curtis Pitts built the first aircraft specifically designed for aerobatics: the Pitts Special S-1. The design was a smaller aircraft than the war-era biplanes and could climb, roll and manoeuvre swiftly. The swept-wing aircraft was powered by a smaller, lighter, horizontally-opposed engine. With the improved centre of gravity, tighter snap rolls could be executed.



Figure A-5 Pitts Special S-1

Note. From "Steen Aero Lab", *Pitts Special S1 Historical Info*. Retrieved November 27, 2009, from <http://www.steenaero.com/PittsS1/history.cfm>



Did you know?

The continued development of the Pitts line created small, lightweight and extremely agile aerobatic aircraft with a high power-to-weight ratio.



Did you know?

Betty Skelton flew a Pitts Special S-1. She was the first woman to fly inverted only a few feet off the ground and slice a 0.6 m (2 feet) wide ribbon strung between two poles. During her first attempt at the ribbon-cutting manoeuvre, her engine stalled but she recovered close to the ground, righted the aircraft and landed safely.

The Stephens Akro competed against the Pitts Special. It was able to overcome the inability of the Pitts to climb vertically. The Stephens Akro used a single wing configuration which reduced drag, therefore allowing higher airspeed which enabled the pilot to achieve higher altitude.



Figure A-6 Stephens Akro

Note. From "The Museum of Flight", 2009, *Stephens Akro*. Copyright 2009 by The Museum of Flight. Retrieved November 26, 2009, from <http://www.museumofflight.org/aircraft/stephens-akro>

The Stephens Akro monoplane design was soon overshadowed by the German Extra design.



Figure A-7 Extra 300L

Note. From "Xtra aircraft", 2009, *Extra Aircraft*. Copyright 2002–2009 by Extra Aircraft. Retrieved November 27, 2009, from <http://www.extraaircraft.com/gallery.asp>

During the 1950s and 60s, the aerobatic category of aircraft design continued to evolve, reaching significant breakthroughs with the first purpose-built aerobatic machines. Use of composites, more powerful engines, larger propellers and improved aerodynamic surfaces and controls created aircraft better suited for the demands of aerobatic flight.



Did you know?

Today's best aerobatic aircraft design differs from the earlier design. Present designs includes:

- structural strength,
- power-to-weight ratio,
- inverted capability (airfoils, fuel and oil systems),
- control authority, and
- stall / snap / spin behaviour.

Today's line of aerobatic aircraft includes designs from numerous countries, including:

- Czech Republic,
- Germany,
- Russia,
- China,
- Britain, and
- the US.



Figure A-8 Zlin

Note. From "Takács Miklós", 2008, *Zlin 526F*. Copyright 2008 by Zlentrener.com.
Retrieved November 26, 2009, from <http://www.zlentrener.com/tipus.php?nyelv=angol>



Figure A-9 YAK 52

Note. From "Wikimedia", 2009, *Yak 52 Wairarapa*. Retrieved November 27, 2009, from http://en.wikipedia.org/wiki/File:Yak_52_Wairarapa.jpg



Figure A-11 Sukhoi SU-26

Note. From "EAA Young Eagles", 2006, *1 001 Aviation Photos*. Copyright 2009 by Experimental Aircraft Association, Inc. Retrieved November 27, 2009, from <http://www.young eagles.org/photos/gallery.asp>



Figure A-11 CAP 232

Note. From "Air Races", 2009, *Mudry CAP 232*. Copyright by Zijde Aviation Photo Publishing. Retrieved November 27, 2009, from <http://www.air-races.com/aircraft/CAP%20232.htm>



Figure A-12 Cessna 152 Aerobat

Note. From "Sport Pilot", *aerobatic aircraft*. Copyright by www.esparacing.com. Retrieved November 1, 2009, from http://www.esparacing.com/sport_pilot/aero_aricraft.htm



Did you know?

Aerobatic displays are not limited to powered aircraft. Today's competitions include aerobatic glider displays.

SECTION 3 MODERN AEROBATIC DISPLAYS



Did you know?

A textbook aerobatic aircraft's position would be precisely controlled and quickly reorient to any other position along all three axes being:

- pitch,
- roll, and
- yaw.

The closest flying machine that can reorient to these positions is the space shuttle.

Aerobatic displays and air racing grew in Europe after WWI. European and American styles of air shows differed. By the mid-1920s, the 'can you top this?' attitude led to the development of aerobatic competitions for private cups and trophies.



Did you know?

The first competition was held in Rheims, France in August 1909. It was in the form of air racing to see which pilot could win in categories, including:

- the highest altitude achieved,
- the longest flight,
- the most passengers in the aircraft, and
- the fastest one-, two- and three-lap flights over a 10 km (6.2 mile) course.

Air racing developed into organized competitions with aircraft racing within a closed-circuit course. The average speed at the first international air race in 1920 on Long Island, New York was 251.8 km/h (156.5 miles per hour). This race led to the establishment of a national air meet which became known as the National Air Races in 1924.

Aircraft had been racing against the clock but at the 1924 competition, aircrafts started racing head-to-head with all aircraft flying a closed-circuit course around pylons.

The air racing competitions soon included air show displays with aerobatic displays. Now meets that were originally just for aerobatic and air racing, combined. Specialized competitions were still held just for one purpose; air racing or aerobatic.



In 1961, Jose Luis de Aresti published his dictionary of all possible aerobatic manoeuvres for the Bücker Bü-133 Jungmeister. This dictionary has grown from around 3 000 to over 15 000 manoeuvres for all models and evolved into the FAI Aerobatic Catalogue.

The Aresti aerobatic shorthand (Sistema Aresti) and scoring system was developed in 1964. Count Jose Aresti scribed line diagrams of his sequence and taped them to his instrument panel. The Sistema Aresti evolved and was added to the FAI Aerobatic Catalogue. The FAI Aerobatic Catalogue is the undisputed last word on aerobatic figures.

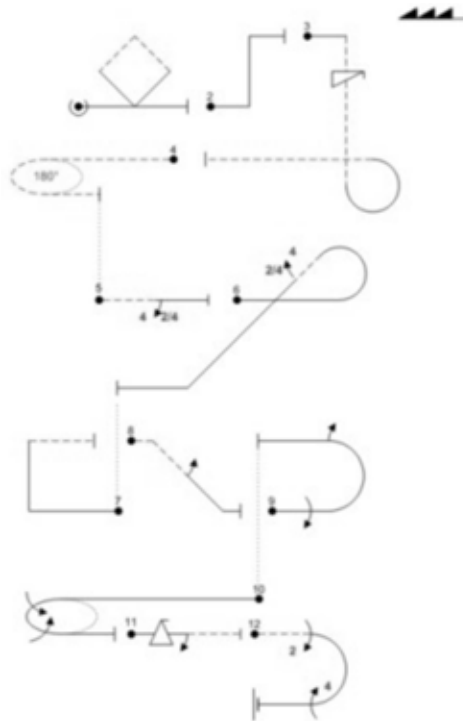

Figure A-13 Sistema Aresti

Note. From "Sport Pilot", *aerobatic competition*. Copyright by www.esparacing.com.
Retrieved November 1, 2009, from http://www.esparacing.com/sport_pilot/aero_aricraft.htm

The FAI Aerobatic Catalogue and the Sistema Aresti were the final steps to the standardization and evaluation of formal aerobatic flight.

The progression of aerobatics developed along a dual track with some pilots continuing to display informal aerobatic air show manoeuvres while others followed the rigorous standardized competition approach.

Aerobatic Clubs have grown around the world. Many chapters of these clubs promote international competitions based on FAI and the International Aerobatic Club (IAC) rules and regulations.

Aerobatics Canada promotes aerobatic displays and competitions through its chapters, including:

- Alberta,
- British Columbia,
- Gatineau, Quebec,
- Manitoba, and
- Southwestern Ontario.

The standardization of modern aerobatic displays has evolved into a set of required manoeuvres in normal and inverted flight. The sequences must be flown with split-second timing, precise speed and altitude control, constant calculation for variables such as wind and temperature, and precise planning on the pilot's part.



Did you know?

The Red Bull races that started in 2001 was a combination of air racing competitions in that the aircraft is racing against the clock using specialized aerobatic turns to manoeuvre through a closed-circuit course of pylons (air gates).

In 2005, the individual Red Bull Air Race World Series was inaugurated with seven races in various countries (2009 had 12 races).

At air competitions, there are five FAI levels in aerobatics, including:

- basic,
- sportsman,
- intermediate,
- advanced, and
- unlimited.

Each competition has five to nine judges with assistants, positioned about 150–250 m from the edge of the box. Corner judges monitor the pilot's position at the edge and give penalties for aircraft leaving the box.

Each judge grades each individual figure as well as how well the sequence is positioned within the box. Each judge has a copy of the performing pilot's routine and scores for the level of difficulty of each manoeuvre.



Imagine flying within a space 3 000 feet by 3 000 feet box with an upper limit of 1 000 feet, at high speed. You must complete specific manoeuvres and you are penalized for leaving the box.

Sounds like similar rules for a drill competition.



Anyone with a computer can perform aerobatic displays using early aircraft to modern high performance aircraft. New simulator designs can assist you in finding the aerobatic sensation.



Did you know?

Programmes are classed as:

- known:
 - determined each year by the FAI and all competitors fly at all contests;
- free:
 - each pilot demonstrates their personal flying skills, creative talent and aircraft performance by designing own sequence;
- unknown:
 - the chief judge chooses and announces the figures to the pilots 24 hours before the competition; and
 - no prior practice is permitted; and
- 4-minute free:
 - top unlimited pilots are invited to fly this final program; and
 - new figures are allowed to be flown at this time to increase the pilot's score.



For more information and descriptions of aerobatic figures or how to get started in aerobatics, you can look online at http://www.esparacing.com/sport_pilot/aerobatic%20figures.htm

SECTION 4 CANADIAN AEROBATIC TEAMS

Many countries have both civilian and military demonstration teams to amaze and thrill the public at air shows. US Army Air Corps Red Knights was formed in the 1930s, the same time period the Canadian "Siskins" started flying. The pilots and ground crews demonstrated the skill and proficiency common to the level of other teams flying.

Siskins

The "Siskins" was a demonstration team consisting of a team of three Siskins from the Royal Canadian Air Force (RCAF) from 1926–1932. They were formed at Camp Borden, Ont. and toured Canada demonstrating formation and individual displays.



Figure A-14 Siskin

Note. From "Airforce", 2004, *Armstrong Whitworth Siskin*. Retrieved November 30, 2009, from <http://www.airforce.forces.gc.ca/v2/equip/siskin-eng.asp>

RCAF Golden Hawks

In 1959, the RCAF Golden Hawks demonstration team was formed. The team flew until 1963. The team consisted of nine F-86 Sabres and represented Canada's first jet-powered aerobatic team. The team perfected many of the aerobatic stunts adopted by other flying teams. The team introduced the two-solo-pilot routine and were the only team to loop and roll the five-card formation. The team flew low and fast over the heads of the air show crowds.



Figure A-15 Golden Hawk

Note. From "The Torch", 2009, *RCAF Golden Hawks Reunion/F-86 Sabre Flying with Snowbirds/RCN Grey Ghosts*. Retrieved November 30, 2009, from <http://www.toyoufromfailinghands.blogspot.com/2009/04/rcaf-hawks-reunion-86-sabre.htm>

RCN Grey Ghosts

The Royal Canadian Navy (RCN) was flying the Banshee from the deck of the Canadian aircraft carrier, Her Majesty's Canadian Ship (HMCS) Bonaventure. The four plane aerial display team called the "Grey Ghosts" flew during the 1960's. The Banshee was Canada's only operational naval jet fighter.



Figure A-16 Grey Ghosts

Note. From "The Torch", 2009, *RCAF Golden Hawks Reunion/F-86 Sabre Flying with Snowbirds/RCN Grey Ghosts*. Retrieved November 30, 2009, from <http://www.toyoufromfailinghands.blogspot.com/2009/04/rcaf-hawks-reunion-86-sabre.htm>

The Golden Centennaires

The Golden Centennaires were formed for Canada's centennial year (1967). The demonstration team flew the CT-114 Tutor but also had a CF-101 Voodoo and CF-104 Starfighter as part of the air demonstration team. They flew a hundred shows across Canada and performed eight shows in the United States.

The team was disbanded at the end of the centennial year but was the forerunner for the Snowbirds.



Figure A-17 CT-114 Tutor

Note. From "Cold Lake Airshow", 2009, *Golden Centennaires*. Retrieved November 30, 2009, from http://www.coldlakeairshow.com/main/index.php?option=com_content&view=article&id=123&Item=133

The Snowbirds

In 1971, the Snowbirds first performed and on April 1, 1978, the squadron was established as the Canadian Forces Air Demonstration Team (CFADT); 431 (Air Demonstration) Squadron. For seven years, the team from CFB Moose Jaw, Sask., operated on a year-to-year basis, performing aerobatic formation manoeuvres. Performances increased yearly to include:

Abbotsford, B.C.,

Canadian National Exhibition (CNE), Toronto, Ont, and

Arctic Circle.



Figure A-18 Snowbirds

Note. From "National Defence", 2009, *Snowbirds, Multimedia, Photo Gallery*. Retrieved November 30, 2009, from <http://www.snowbirds.dnd.ca/v2/multimedia/photo-eng.asp>

Since the formation of the Snowbirds as an official unit within the CF, the demonstration team has performed above millions of spectators across North America.



Did you know?

During the 100th anniversary of flight in 2009, various aircraft demonstration shows included an F-86 and CF-18 painted in anniversary colours and other demonstrations by the Snowbirds.

Non-military

With affordability of aircraft, individuals can purchase and train on aerobatic category aircraft. With research, individuals can find flight centres that have aerobatic training aircraft and skill instructors.

Non-military solo pilots and teams come and go but these individuals provide exciting aerial demonstrations at their local airport or scheduled air shows across the country.



Aviation enthusiasts perform yearly as solo pilots and formation civilian teams. Have you seen non-military aerobatic demonstrations at any air show you have attended?

CONCLUSION

The history of aerobatic aircraft and the creation of all manoeuvres included in the FAI Aerobatic Catalogue progressed over the years mainly for the premise "can you do this?". The use of aerobatics over the years provided military pilots with new skills to support the combat role during WWI and WWII.

The manufacturing of aircraft provided better control by the pilot to invent new ways to manoeuvre the aircraft in flight. Designers learned and produced better aircraft frames, control surfaces and systems leading to higher performing aircraft. Pilots then produced new manoeuvres.

With the continued aeronautical development of aircraft, pilots will push the envelope further for their personal accomplishments and for the thrill of showmanship for the air show public.





Congratulations, you have completed your self-study package on EO C570.01 (Examine The Aspects of Aircraft Manufacturing and Maintenance Through the Development of Aerobatic Aircraft). Complete the following exercise and hand your completed package to the Training Officer / Proficiency Level Officer who will record your completion in your Proficiency Level Five logbook.





SELF-STUDY REVIEW

Place an X in the column which relates to the information about the era of aerobatic development.

Information	Pre-WWI	WWI	Pre-WWII	WWII and on
Adolphe Pegoud was drenched in fuel				
Airframes collapsed when pulling out of dive				
FAI Aerobatic Catalogue				
First air race on Long Island, New York				
G forces				
Immelmann Turn				
Individual teams joined together to barnstorm				
Len Povey - Cuban Eight				
Lincoln Beachey - father of aerobatic flying				
Lomcevak				
Oswald Boelcke - father of air combat				
Wilfred Parke recovered from stall and spin				
Zurich, Switzerland's large scale aerobatic competition				

Place an X in the column to identify the era when the aircraft was first flown.

Aircraft	Pre-WWI	WWI	Pre-WWII	WWII and on
				
				

Aircraft	Pre-WWI	WWI	Pre-WWII	WWII and on
				
				
				
				

Mark the Canadian Demonstration teams in sequence of Operation (1-5).



Canadian Demonstration Teams	Operational sequence
RCN Grey Ghosts	
RCAF Golden Hawks	
The Golden Centennaires	
Siskins	
The Snowbirds	





SELF-STUDY REVIEW ANSWER GUIDE

Place an X in the column which relates to the information about the era of aerobatic development.

	Pre-WWI	WWI	Pre-WWII	WWII and on
Adolphe Pegoud was drenched in fuel	X			
Airframes collapsed when pulling out of dive	X			
FAI Aerobatic Catalogue				X
First air race on Long Island, New York	X			
G forces				X
Immelmann Turn		X		
Individual teams joined together to barnstorm			X	
Len Povey - Cuban Eight			X	
Lincoln Beachey - father of aerobatic flying	X			
Lomcevak				X
Oswald Boelcke - father of air combat		X		
Wilfred Parke recovered from stall and spin	X			
Zurich, Switzerland's large scale aerobatic competition			X	

Place and X in the column to identify the era when the aircraft was first flown.

	Pre-WWI	WWI	Pre-WWII	WWII and on
				X
	X			

	Pre-WWI	WWI	Pre-WWII	WWII and on
			X	
				X
			X	
		X		

Mark the Canadian Demonstration teams in sequence of Operation (1-5).

Canadian Demonstration Teams	Operational sequence
RCN Grey Ghosts	3
RCAF Golden Hawks	2
The Golden Centennaires	4
Siskins	1
The Snowbirds	5

THIS PAGE INTENTIONALLY LEFT BLANK



**ROYAL CANADIAN AIR CADETS
PROFICIENCY LEVEL FIVE
INSTRUCTIONAL GUIDE**



SECTION 1

EO C590.01 – ANALYZE AN AIRCREW SURVIVAL CASE STUDY

Total Time:	90 min
-------------	--------

PREPARATION

PRE-LESSON INSTRUCTIONS

Resources needed for the delivery of this lesson are listed in the lesson specification located in A-CR-CCP-805/PG-001, *Proficiency Level Five Qualification Standard and Plan*, Chapter 4. Specific uses for said resources are identified throughout the self-study package within the section for which they are required.

Self-study packages are intended to be completed by the cadet independently. More information about self-study packages can be found in the foreword and preface.

Review the lesson content and become familiar with the material prior to facilitating this lesson.

Photocopy the self-study package located at Attachment A for the cadet.

Photocopy the answer key located at Attachment B but **do not** provide it to the cadet.

PRE-LESSON ASSIGNMENT

Nil.

APPROACH

A self study was chosen for this lesson as it allows the cadet to analyze an aircrew survival case study at their own learning pace. This encourages the cadet to become more self-reliant and independent by focusing on their own learning instead of learning directed by the instructor.

INTRODUCTION

REVIEW

Nil.

OBJECTIVES

By the end of this lesson the cadet shall have analyzed an aircrew survival case study.

IMPORTANCE

It is important for cadets to analyze a case study as it allows the cadet to learn from the actions of others.

SELF-STUDY PACKAGE INSTRUCTIONS

OBJECTIVE

The objective of this self-study package is to have the cadet examine a case study of an actual aircrew survival incident.

RESOURCES

- Self-study package, and
- Pen / pencil.

ACTIVITY LAYOUT

Provide the cadet with a classroom or training area suitable to complete the self-study package.

ACTIVITY INSTRUCTIONS

1. Provide the cadet with a copy of the self-study package located at Attachment A and a pen / pencil.
2. Allow the cadet 90 minutes to complete the self-study package.
3. Provide assistance as required to the cadet.
4. Collect the self-study package once the cadet has finished.
5. Correct the self-study package with the self-study package answer key located at Attachment B.
6. Provide feedback to the cadet and indicate whether or not they have completed the Enabling Objective (EO).
7. Return the completed self-study package to the cadet for their future reference.
8. Record the result in the cadet's logbook and Cadet Training Record.

SAFETY

Nil.

END OF LESSON CONFIRMATION

The cadet's participation in completing the case study will serve as the confirmation of this lesson.

CONCLUSION

HOMEWORK / READING / PRACTICE

Nil.

METHOD OF EVALUATION

Nil.

CLOSING STATEMENT

A case study helps you to understand the principles involved in reaching a solution or analyzing an issue. This case study allows you to gain experience through the actions of others without experiencing the hardships / dangers yourself.

INSTRUCTOR NOTES / REMARKS

Nil.

REFERENCES

A3-016 B-GG-302-022/PT-001 Director Air Operations and Training. (1978). *Down but not out*. Ottawa, ON: Department of National Defence.

C3-002 ISBN 0-00-653140-7 Wiseman, P. (1999). *The SAS survival handbook*. Hammersmith, London: HarperCollins Publishers.

C3-003 ISBN 1-8967-00-9 Tawrell, P. (1996). *Camping and wilderness survival: The ultimate outdoors book*. Green Valley, ON: Author.

C3-352 1932nd Communication Squadron. (2009). *Crash in the wilderness circa 1942*. Retrieved October 9, 2009, from <http://www.lswilson.ca/page8.htm>

C3-353 British Columbia Outdoor Wilderness Guide. (2009). *Wilderness survival guide: Basic wilderness survival skills*. Retrieved October 9, 2009, from <http://www.bdadventure.com/adventure/wilderness/survival/basic.htm>

THIS PAGE INTENTIONALLY LEFT BLANK

Analyze an Aircrew Survival Case Study



CLOCKWISE FROM TOP LEFT
1ST LT GC HODGE, PILOT
2ND LT FW JANSSEN CO-PILOT
CPL FJ GALM, RADIO OPERATOR
BAILEY, ENGINEER

TAKING DELIVERY OF A
BRAND NEW B-26B AT
BAER FIELD, INDIANAPOLIS
INDIANA, OCTOBER 1942

"TIMES A WASTIN" PAINTED
IN BRIGHT YELLOW

PHOTO COURTESY OF
JOHN & ALMA ROSE

SECTION 1: CASE STUDY

SECTION 2: BACKGROUND KNOWLEDGE

SECTION 3: AIRCREW SURVIVAL

SECTION 1
CASE STUDY

A TRAGEDY VINTAGE 1942
PRESENTED BY
THE 1932nd COMMUNICATIONS SQUADRON (AFCS)
GOOSE BAY AIR BASE, LABRADOR, CANADA

On the coast of Labrador, the icy waters of snow-fed streams flow to meet the sea through the steep, rocky walls of Saglek Fjord. Between June and October they flow, but for the remainder of the year all exposed water is frozen, often to the depth of several feet. Archaeologists have uncovered residue of ancient residents who hunted and fished the waters of the fjord as early as 2580 BC. Their stone hearth, with charcoal still intact, has been uncovered on Rose Island in the mouth of the bay.

Today, a small United States (US) Airforce converted radar site houses a tropospheric communications link to the northernmost outposts of the hemispheric defence system. From the steep heights, US contractor maintenance personnel overlook the vast stretches of frozen tundra and infrequently visible blue-green of the Atlantic. On a flat stretch of this barren land, at the base of the steep bluff, now crowned by a radome and the concave, billboard antennas of the site, our story finds a setting. No more than 46 m (50 yards) from the present site runway, lie the weathered remains of a B-26 medium bomber of World War II vintage.

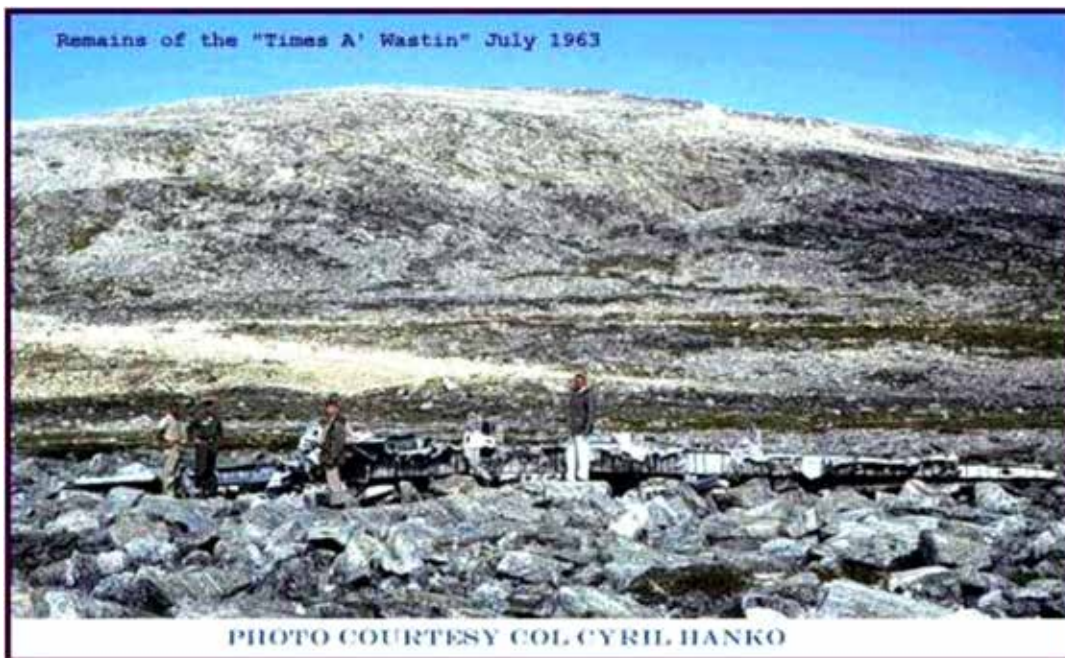

Figure A-1 Remains of the B-26 Marauder "Times A Wastin"

Note. From 1932nd Communication Squadron. (2009). *Crash in the Wilderness Circa 1942*. Retrieved October 9, 2009, from <http://www.lswilson.ca/page8.htm>

The story begins at BW-1, Narsarsuaq, Greenland, as the long arctic winter has shortened the days and is closing in as the seven man crew of a Martin B-26 Marauder medium bomber of the 440 Squadron, 319 Bomb Group, the "Times A Wastin" awaits clearance for the flight home—first stop Goose Bay, Labrador.



Figure A-2 B-26 Marauder Similar to "Times A Wastin"

Note. From 1932nd Communication Squadron. (2009). *Crash in the wilderness circa 1942*. Retrieved October 9, 2009, from <http://www.lswilson.ca/page8.htm>

<i>Data from Quest for Performance and Jane's Fighting Aircraft of World War II</i>	
General Characteristics	
Crew	7 (2 pilots, bombardier/navigator, radio operator, 3 gunners)
Length	58 ft 3 in (17.8 m)
Wingspan	71 ft 0 in (21.65 m)
Height	21 ft 6 in (6.55 m)
Wing Area	658 pi ² (61.1 m ²)
Empty Weight	24 000 lb (11 000 kg)
Loaded Weight	37 000 lb (17 000 kg)
Powerplant	2× Pratt & Whitney R-2800-43 radial engines, 1 900 hp (1 400 kW) each
Performance	
Maximum Speed	287 mph (250 knots, 460 km/h) at 5 000 feet (1 500 m)
Cruise Speed	216 mph (188 knots, 358 km/h)
Landing Speed	114 mph (90 knots, 167 km/h)
Combat Radius	1 150 mi (999 NM, 1 850 km)
Ferry Range	2 850 mi (2,480 NM, 4 590 km)
Service Ceiling	21 000 ft (6 400 m)
Wing Loading	46.4 lb/ft ² (228 kg/m ²)
Power/Mass	0.10 hp/lb (170 W/kg)
Armament	
Guns	12 × .50 in (12.7 mm) Browning machine guns
Bombs	4 000 lb (1 800 kg)

Figure A-3 B-26 Marauder Data

Note. From "Wikipedia", 2010, *B-26 Marauder*. Retrieved February 2, 2010, from http://en.wikipedia.org/wiki/B-26_Marauder

Crew of the "Times A Wastin"

Pilot: First Lieutenant GC Hodge
Co-Pilot: Second Lieutenant P Janssen
Navigator / Bombardier: Second Lieutenant EJ Josephson
Radio Operator: Technical Sergeant CF Nolan
Gunner: Sergeant R Weyrauch
Gunner: Corporal JJ Mangins
Gunner: Corporal FJ Galm

The weather turned sour and the pilot was forced to crash land at the head of the Saglek Fjord in Labrador. The aircraft sustained minimal damage and the crew survived the impact unscathed. What follows is their efforts to survive in one of the most unfriendly and hostile landscapes on Earth at the worst possible time of year. The diary of the pilot has been retained intact; the last entry added was in February 1943. Except for names and places, spelling and punctuation have been retained as they appeared.

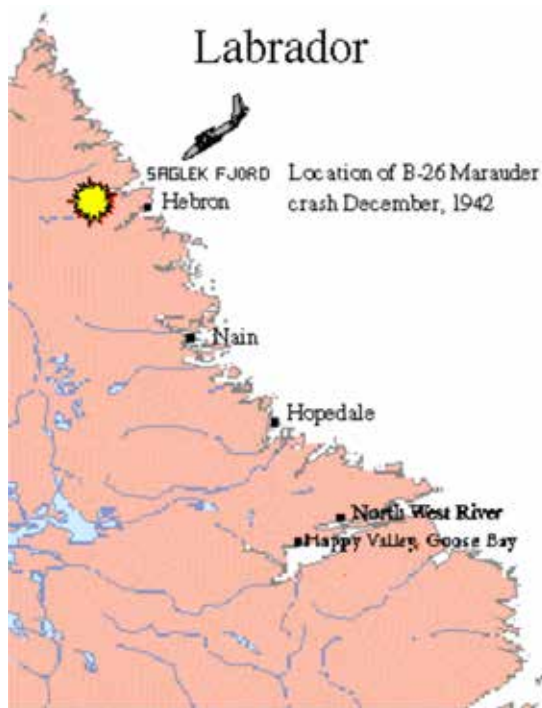

Figure A-4 Crash Site

Note. From 1932nd Communication Squadron. (2009). *Crash in the Wilderness Circa 1942*. Retrieved October 9, 2009, from <http://www.lswilson.ca/page8.htm>

Distances and Headings:

Narsarsuaq, Greenland to Goose Bay, Labrador: 1250 km at 232°
Crash Site (Saglek) to Goose Bay: 590 km at 167°
Crash Site to Hebron: 30 km at 177°



Figure A-5 Crash Site Marked With an "X"

Note. Created by Director Cadets 3, 2010, Ottawa, ON: Department of Defence.

Glossary

500 Rummy. A card game.

A-10. The Strike, an attack (light) bomber.

A-20. The Havoc, an attack (light) bomber.

B-25. The Mitchell, a medium bomber.

Dingy radio. Small emergency radio.

Goose beam. The radio directional beacon from Goose Bay, Labrador.

Liaison receiver / set. Radio used to communicate (liaise) with other aircraft, ground stations, etc.

Minutes. A unit of time and of angular measure (1/60 of a degree).

P-40. The Warhawk, a fighter aircraft.

Putput. On-board auxiliary power unit (generator) used to start the engines and for ground operation of on-board electrical equipment.

Star shot. Determining one's location using the positions of stars.

Stations. Establishments equipped to transmit and receive radio signals (eg, ham radio operations).

The Diary Begins

Note. From 1932nd Communication Squadron. (2009). *Crash in the Wilderness Circa 1942*. Retrieved October 9, 2009, from <http://www.lswilson.ca/page8.htm> The diary has been modified to only include the pilot's entries.



The first three diary entries describe the crew's actions in Narsarsuaq, Greenland during their wait for good flying weather.

NOVEMBER 12, 1942

We're still sitting here with 16 minutes (less) of daylight each day. We've less than six hours of daylight between sunrise and sunset now. Had about two inches of snow last night and everything was really pretty. Spent most of the morning sweeping it off the plane. They said that there's a chance of leaving tomorrow but this place seems so much like home that it doesn't seem like we should leave.

NOVEMBER 16, 1942

This place is full of changes. Yesterday afternoon Janssen and I walked down to the river. There was a solid sheet of ice resting on the rocks, and it was covered with almost two inches of snow. Every once in a while, we would break through up to our knees, but there was nothing under the ice. Last night we had rain with a warm wind with gusts up to 60 miles per hour. So this morning there was only isolated patches of ice left. Today was the first time in two weeks that we have been able to walk on bare ground. We've had all kinds of weather, most of the days were fairly warm. But one day it was six degrees. We've seen days when not a breath of air stirred.

NOVEMBER 26, 1942

I still say this is screwy weather. We were alerted this morning at 0330. There was a solid overcast. We killed time until 0600 when we got briefed. It was still overcast and seemed to be getting worse. The A-10s and B-25s started kicking off, but about then it started to rain and the ceiling looked like it was very low. About 10 minutes later it stopped raining and an A-20 came over at 600 feet with room to spare. By 0830, the sun was shining and everything looked as nice as we could ask for, but it was too late to take off.



The December 10 diary entry describes the day of the crash.

DECEMBER 10, 1942

Took off at last for Goose Bay. About one hr 15mins out, we ran into some clouds and I turned around and called for the formation to turn around also. One plane dropped out. I think I saw the P-40s later. I lost the others while letting down below the clouds. We saw an opening to the south at about 2000 feet and after flying in that direction we broke out. We finally had to go back up to 13000 feet, but it was clear sailing, so we kept on. Lt Josephson gave me a new heading to get back on course, but we know now it was too much of a correction. About halfway I picked up Goose beam, but the set went dead after a few minutes. It was too late to turn back then, so we tried to get it on the compass, but couldn't. We finally hit the coast. We decided we were south of Goose Bay, so we turned north until we finally realized we were north. We were almost out of gas, so I started looking for a place to land. I wanted to get back to where there were trees, but the engine started missing, so we came back down. The crew never batted an eye when they were told that we were going to have to make

a crash landing. Even if I do say so myself, it was a good landing and Lt Josephson did a good job cutting the switch. We hit a rock that tore the bombay open and one prop tip went through the fuselage behind me. Outside of that, the ship was intact. It swung around almost 90 degrees without stopping, but made a good wind break that way; it was almost dark so after eating a cold ration we went to bed inside the ship; we had 17 blankets, a comforter and a bedroll, but we slept very well. Lt Josephson took a star shot and decided we were 300 minutes from Goose.



The aircraft landed **above** the treeline.

DECEMBER 11, 1942

Lt Josephson walked to the fjord to the west and Galm the one to the east. We spent most of the day clearing up the ship and pooling rations in the afternoon. I climbed the mountain in front of us, but didn't learn much. Nolan worked on the putput all day without results. We cranked the dingy radio. It was pretty windy so we spent the night in the ship.

DECEMBER 12, 1942

Made three big improvements in our situation. Lt Janssen and Galm discovered a lake close to our ship and saw a fox. Weyrauch and I saw 50 seals; so we know that there is food here. We made a lean-to out of tarp under the wing and slept there. It was much better.

DECEMBER 13, 1942

When the star shots were figured out it showed us to be close to the town of Hebron. Worked on the putput all day without success, so we tried to work the liaison set on the batteries but they were too weak. We pooled our covers and slept together.

DECEMBER 14, 1942

Wind blew all day with increasing velocity and snow. Our lake went dry so we were back to melting snow. Went to bed early.

DECEMBER 15, 1942

Had to eat a cold breakfast because the wind blew too much snow in our fire. Nolan changed the voltage regulators and got 25 volts, long enough for me to get a couple of stations on the liaison receiver. The output stopped, but we hope we know what is wrong with it. So we hope to get a message out soon.

DECEMBER 17, 1942

The putput went out, but we did try the batteries. They too, were dead.

DECEMBER 19, 1942

More snow last night. Nolan and Mangins tried to work on the putput but it was too cold. We built a fire in the lean-to and thawed out.

DECEMBER 20, 1942

It was so windy we stayed in bed all day.

DECEMBER 21, 1942

Everything was really snowed in so we spent the day eating and thawing out blankets and planning a trip south. Lt Josephson Lt Janssen and Sgt Nolan plan to head south in the boat the first clear day.



The December 21 diary entry introduces the crew's plan to split up. Three of the seven crewmembers plan to use the aircraft's emergency raft, referred to as "boat", to travel south to get help. These three crewmembers are the "boatmen" described in the December 22 diary entry and are referred to as "boys" in several later entries.

DECEMBER 22, 1942

Had a perfect day, the first clear day in over a week. We worked on the boat and cleared snow away from the lean-to all day. We ate a pretty big meal with the three boatmen eating a little extra.

DECEMBER 23, 1942

Got up at 0715, got the boat ready and started carrying it. The wind was pretty strong and the boat was heavy, so we had a pretty hard time of it. We didn't get to the water until noon and then it took quite a while to find a place to put it in the water. We intended to put them off shore, but they appeared to be making slow headway to the south. That was the last time we saw them. We had a hard time coming back across the snow. We had some peanuts and caramels and went to bed.



The three boatmen are never heard from again and no evidence has been found to explain what happened to them. It can be assumed that they succumbed to hypothermia on the freezing cold waters of the Labrador Strait and drifted south on the Labrador Current into the Atlantic Ocean.

DECEMBER 24, 1942

Christmas Eve and we've been here two weeks today. It was lonesome with just the four of us, but we got up pretty early and dug out the gas strainer so we could make a fire. It was so windy we couldn't work outside so we dried out blankets. Galm got blisters pretty bad and swollen hands which have to be doctored. We stretched out our eating to cover most of the day. We had a sardine sized can of herring with crackers, a spoonful of peanuts a piece, a black cough drop, and a caramel, a cup of grape drink, and plenty of coffee, using the same grounds over and over. It's really a surprise how much one can get from a small thing like a caramel, but we look forward to it with anticipation each day.

DECEMBER 25, 1942

What a Christmas. Mangins' feet pained him so much we had to get up at 0330. He was in agony before that, but was better after, although his arches pain him pretty bad. Got up again at 0900. Galm went exploring, I massaged Mangins' feet and Weyrauch started fixing up the floor, which was in pretty bad condition from the fire. Later we had to dig out the rear entrance to the ship to fix the window up. After that, we had a first aid lesson. The only one who doesn't have anything wrong is me. We are about to eat our Christmas dinner and go to bed.



Galm's and Mangin's injuries described in the previous two diary entries are consistent with frostbite.

DECEMBER 26, 1942

Had another swell day. The weather was perfect. Weyrauch cleaned up the back of the ship, while Galm dug around in the rear of the bombay, uncovering a can of fruit cocktail and a can of chicken a la king. I worked on Mangins' feet and did some odd jobs. Everyone is feeling better, and I hope that Mangins will be up in a few days. We aren't starving by any means, but the conversations are mainly about food. One surely can remember some tasty food.

DECEMBER 27, 1942

Started today as usual by treating the casualties. Mangins' feet are better, but we found a big blister on each foot. Galm and Mangins spent the day drying blankets. Weyrauch finished cleaning out the back of the ship, and I climbed the mountain to see if I could see anything out to sea. I also took a roll of film. The enforced diet is beginning to tell on us, but we'll eat a little more tomorrow.

DECEMBER 28, 1942

This has been a terrible day. The wind started up early in the morning and has kept us inside all day. We had two fires which took the rest of the day to repair. Mangins' feet are quite a bit better and he will start working on the putput soon. We may get the liaison set going yet. In the meantime, we can feel the effects of the short rations more every day. We pray almost every minute that the boys in the boat will get through soon and get some help.

DECEMBER 29, 1942

Today has been just average. The wind started up early again, but not too hard. Mangins' feet are almost back to normal.

DECEMBER 30, 1942

Today was overcast with snow showers. Spent most of the day working on the inside. Galm lost a fingernail, and may lose another. I'm just thankful that his hand doesn't pain him. Worked a little on the putput and made some progress, but it was too dark to work much. Got up a game of 500 Rummy which everyone seemed to enjoy. The boys have been gone a week today, God grant they are still going.

JANUARY 1, 1943

Happy New Year. It snowed and blew all night long and kept it up all day. So since we had no fire we stayed in bed all day.

JANUARY 2, 1943

More wind and snow today. It slackened up a little around noon, so we got up with the aid of a fire in a peanut can. Weyrauch got the prop and receiver tank out with a gallon of alcohol and glycerine, and I dug out the oil drain. After that, we had a couple of hot fires and plenty of hot coffee and had a lemon powder and a cup of bouillon. Our main dish was the last can of datenut roll with jelly and it was very good. We didn't finish with the eating and drinking until almost noon. Then I worked on Mangins' feet and went to bed. There was quite a bit of loose snow outside but the very shape of our ship keeps it fairly clean. It actually rained today and I don't know what effect that is going to have on our situation. The boys have been gone ten days today, which is the time we figured it would take them to make the trip. We hope they made it and can bring help soon.

JANUARY 3, 1943

There wasn't much wind last night so we thought we would have a good day, but the wind picked up and it snowed all day. The ship had a sheet of ice on it and is covered with snow. Besides that, the drifts are higher and closer than they have ever been before. We hooked up the fuel transfer pump and I'm positive we pumped some gas over to this side but we couldn't get it to drain out so we had to use the alcohol to cook with. I got

into a big hurry once and caused a fire in which I got burned but not badly. Now we are all wearing bandages. I found two bouillon cubes in the radio operator's desk. Spent a lot of time putting snow under our bed. There was quite a hole there, so we should be able to sleep better tonight. It must be raining outside now. It couldn't be melting ice on the wing. We keep praying for clear weather and hope that the boys get through. Also to try out a new theory to where Hebron is.

JANUARY 4, 1943

Had a blue sky when we got up, but it stayed overcast all day. There wasn't much wind, however, so we got up and went to work. Weyrauch and I got quite a bit of gas out of the other wing, so we are pretty well fixed on that. Mangins has the putput almost ready to try again. We are just praying for good weather both in hopes of a rescue plane (if the boys got through). I am cutting down still on the rations.

JANUARY 5, 1943

It started off like a beautiful day, but turned to a light low overcast. Weyrauch and I cleaned the plane of snow and Mangins finished the putput, which seems to be in pretty good shape. It started clearing late this afternoon.

JANUARY 6, 1943

This is the eighth day of bad weather. The entrance is blocked, and it doesn't do any good to dig it out. It has been two weeks since the boys left and spirits are still high in spite of the bad weather.

JANUARY 7, 1943

We've been here four weeks today. The entrance was blocked up this morning. As I was going into the ship, I saw a little bird. We caught him and boiled him for a couple of hours. Then made a stew by adding a bouillon powder. It was really delicious. Galm started to go looking for Hebron, but the snow was too soft. Mangins got out for the first time in 13 days. If we can't find a town or get the putput going in three days, we are going to have to sit and wait until the weather clears and pray that the boys got through because we are too low on food to do anything else. God help us to get out of here safely.

JANUARY 8, 1943

Today was the most strenuous for me since we got here. I tried to get to Hebron, and I still think I know where it is, but there are two mountains in the way. I can feel myself growing weaker and we have less to eat every day. I don't know what we would do if we didn't have that three pounds of coffee. We sit around and drink that and talk about all kinds of food, but I think we all crave chocolate candy more than anything else. The boys have dug out the back of the ship so if tomorrow is clear, we still have one last try with the putput radio.

JANUARY 9, 1943

Well, we put the putput back in its place and it jammed again, so that leaves us with one possibility, that the boys get through.

JANUARY 10, 1943

We have been here one month today, 31 days. Spent most of the day which was perfect as far as the weather was concerned looking for the plane and fixing up bandages. The boys spirits were much higher today after our little church service. Our only food today was a slice of pineapple and two spoons full of juice.

JANUARY 11, 1943

Our third day of perfect weather, also the coldest day since right after we got here. Spent the day watching for the plane which didn't come. The oil gave out on this side, which brings about another problem. The short rations are beginning to tell on us, but we are still in high spirits. If we don't live to eat some of the food we talked about, we've mentally eaten one of the best meals in the world.

JANUARY 12, 1943

Today was the boys' 20th day and our 33rd, and was overcast, but was calm. We got the oil almost dug out but are all so weak that we can hardly work. The boys spirits are still high though, and we had a couple of lively bull sessions on our one topic, food. Our ration today was a slice of pineapple.

JANUARY 13, 1943

Another calm overcast day. We dug up the oil, dried out blankets, made a new bed on snow and ate our last food, a slice of spam and a soda cracker a piece. All we have left is a half pound of chocolates and three drink powders, but we talk like rescue was certainly tomorrow. It cleared off late this afternoon, so maybe there is hope for tomorrow.

JANUARY 14, 1943

Clear day but with wind. We cleaned off the plane and waited, but nothing happened. Late this afternoon we were playing cards when Mangins oiled the gas to fast and caused an explosion which burned both his and my face, hair, and hands. Our rations were four chocolates, but we are still working out pretty well. After a devotional, we went to bed.

JANUARY 15, 1943

A perfect day as to weather, but the coldest since we got here. Spent most of the day trying to keep warm and listening for a plane. Also made big plans for a couple of days in New York when we get our furloughs. Rations were two chocolates and a bouillon powder. No one is particularly hungry yet, but we are getting weaker and colder because our bodies aren't putting out enough heat.

JANUARY 16, 1943

Another calm clear day, but the coldest we have had yet. The oil froze up, so we had to end up burning nothing but gas. The only thing we have left is one bouillon powder and two sticks of gum. The strain is beginning to tell, but we still have good bull sessions about food and the furlough in New York.

JANUARY 17, 1943

Couldn't have asked for a better day except that it is so cold that the oil is frozen and won't burn. So our gas is going pretty fast. Had our last food, bouillon powder, so unless rescue comes in a few days -----. The boys have been gone 25 days which is a long time, but they are our only hope; our families will really miss some swell dishes and menus.

JANUARY 18, 1943

Cold and clear. My watch stopped, so we didn't get up until noon. Must be a little warmer because we got a little oil. Today was our first complete day without any food, but spirits are still pretty high. It's surprising how much punishment the body and mind can take when necessary. We are still in pretty good condition but rather weak. Not much hope left.

JANUARY 20, 1943

It snowed and blew all night, but we slept pretty well, and we were much more cheerful today. We stayed up longer than we should have though and are pretty tired. That snow has been blowing pretty hard all day and is piling up in front of the door, so I don't know what we will do if it doesn't stop pretty soon.

JANUARY 21, 1943

Six weeks today and rough night with snow and rain, so everything was soaked when we got up. Only Weyrauch and I got up and then only long enough to melt snow for water. Things could be worse.

JANUARY 22, 1943

Got up around noon, and was up until about 6. I cleared up the entrance and made the bed. We could stand some good weather.

JANUARY 23, 1943

Spent a miserable night. Everyone got crowded and nobody could get comfortable. Had a good day, but everybody is pretty discouraged, although the conversation was pretty good. We haven't really felt famished but we are really weak. It really gets me to see these boys start to do something and have to stop from the lack of power to go on. Weyrauch has developed a case of piles and is really suffering.

JANUARY 24, 1943

Overcast but fairly calm. Each day we don't know how we can last another day, but each time we manage to go on. We all smoked a pipe of tobacco this morning and Galm got really sick, and I felt pretty bad. But we came out pretty well.

FEBRUARY 3, 1943

Slept a solid week in bed. Today Weyrauch died after being mentally ill for several days. We are all pretty weak, but should be able to last several more days at least.

NOTE: This is the last entry in the diary. The remains of the crew were found April 9, 1943 by Inuit from the settlement of Hebron, located about 30 km south.

List of food when landed:

- 7 cans of Spam,
- 3 cans of peanuts,
- 8 cans of chicken,
- 2 cans of pineapple,
- 3 cans of fruit cocktail,
- 2 cans of date nut roll,
- 1 can of brown bread,
- 3 boxes of chocolates,
- 28 Hershey Bars,
- 4 packages of dates,
- 1 pound of crackers,
- 4 boxes of fig newtons,
- 1 pound of cheese crackers,
- 1 case of Coke,
- 2 cans of salmon,

- 3 pounds of coffee, and
- 20 packages of caramels.

The original transcript of the pilot's diary was included in the formal report filed by the USAAF team that recovered the remains of the crew on April 18, 1943. Major Vaughan, Lieutenant Holmes and Lieutenant Norton accomplished the recovery by landing at the Inuit settlement of Hebron and walking overland to the crash site. The bodies were returned to Crystal-1 (Fort Chimo, now called Kuujuaq) on April 22, 1943 where a funeral service and interment took place in the US Army cemetery plot the following day.

SECTION 2 BACKGROUND KNOWLEDGE

The following background knowledge was covered during EO M190.04 (Discuss Survival Psychology).

SURVIVAL PSYCHOLOGY

Understanding survival psychology is very important. It is a person's will to survive that helps them the most. Having survival skills is not as important as the will to survive.

The Role of Fear in a Survival Situation

Fear is a normal reaction when in a survival situation. Fear can aid or hinder individuals depending on their reaction to it. It can lead to hopelessness and decreased self-confidence as well as reducing the will to survive. Fear, however, can release adrenaline, giving greater strength and stamina, reducing pain sensation, giving the ability to think clearly and helping one to act purposefully. Accepting fear as a natural reaction to a threatening situation leads to productive behaviour. Because of this, fear can greatly increase chances for survival.

The factors most commonly reported to help decrease or control fear are:

- having confidence in a leader if in a group or in one's self if alone;
- having confidence in one's equipment; and
- concentrating on the job to be done.

	<p>Have you ever been in a real survival situation? If so, how did fear play a role?</p> <hr/> <hr/> <hr/>
---	--

Action to Take When Lost (Employing "STOP")

Taking immediate action when lost in the wilderness is critical to dealing with fear. In such a situation, the STOP acronym should be employed.

Stop. When one becomes lost, stopping prevents the person from possibly moving further away from the area a search crew may cover. It is also important to stop so one can think effectively. By stopping to think, one may avoid making errors due to hasty decisions.

Think. It is critical to think about what actions should be taken once a person realizes they are lost. One should think of the danger and consequences of either staying put or moving on. One should think about the possible dangers that could occur. Analyzing the weather, terrain and available resources should also be taken into account when deciding on the actions to be taken.

Observe. Conduct a self-analysis to identify possible symptoms of physical ailments such as fatigue, increased heart rate, or shivering. Also, look for psychological ailments such as extreme stress or fear. Observe surroundings for resources, weather potential, terrain, and possible landmarks that can provide information on one's current location.

Plan. After thinking of and observing all aspects of the situation, plan a course of action that best uses the available resources.



Do you remember using STOP during your survival training? If so, did it help?

The Survival Pattern

The survival pattern is a procedure used in a survival situation. It is a way of prioritizing tasks.

First aid. The most important thing to address in a survival situation is any injury that may have been sustained. Treating injuries can prevent worsening conditions, and reduce pain. Treating injuries allows for more involvement in survival activities.

Fire. Fire serves many purposes in a survival situation. It can provide warmth, boost morale, and provide a sense of security. It is a method for creating signals and can help purify water and cook food.

Shelter. Shelter allows a person to be warm and dry by providing protection from the elements. Even if the current weather conditions are favourable, it is not always possible to know when and how the weather conditions may change. Therefore, building a shelter early is very important. It also provides the psychological comfort of having a home base.

Signals. Signals should be constructed to attract search teams. Signals can take many different forms. Signal fires with heavy amount of dark smoke are visible from a long distance during the day or night. Other ground to air signals should be large and stand out from the surroundings, or be placed in nearby open areas. A mirror or other reflecting object is an excellent tool for signalling.

Food and water. Survival without water will only last a few days. Lack of water can lead to mild dehydration, which can reduce the ability to concentrate. This in turn can be dangerous as clear thinking is essential in a survival situation. Water from any ground source should be purified before drinking. A person can live for weeks without food. Excessive hunger can cause confusion and lack of judgement. Prolonged starvation results in loss of energy, loss of mental clarity, increased susceptibility to disease, difficulty maintaining body temperature, and eventually death. A balanced and varied diet can improve morale in a survival situation.



The survival pattern is a way to prioritize tasks. Can you think of a situation where the order would be different than what is listed?

The Seven Enemies of Survival

Pain, cold, thirst, hunger, fatigue, boredom, and loneliness are enemies of survival. In a survival situation, these feelings are more severe and more dangerous than in normal situations. Having knowledge of these feelings and their effects can assist in overcoming and controlling them.

Pain. Pain is nature's way of identifying problems. However, pain can subside if one is pre-occupied. Pain may go unnoticed if one's mind is occupied with plans of survival. Once a person gives into pain, it weakens the drive to survive. A special effort should be made to keep one's hopes up and keep working.

Cold. Cold lowers the ability to think and the will to complete necessary tasks for survival. Focusing on being cold can interfere with the goal of survival. Cold can numb both the mind and body. It can also lead to serious medical problems. Find ways to get and stay warm, like building a fire, getting dry, layering clothes, and keeping busy.

Thirst. Water is vital for survival. Dehydration can lead to serious medical problems, and can eventually be fatal. Even when thirst is not extreme, it can dull the mind. Drink regularly, and try to find sources of water.

Hunger. Hunger is dangerous because it can lessen the ability for rational thought. Both thirst and hunger increase a person's susceptibility to the weakening effects of cold, pain and fear. Prolonged hunger can lead to serious medical problems and can eventually be fatal. Manage food supplies, set snares, fish, and collect edible plants.



Did you know?

You can survive about three minutes without air, about three days without water and about three weeks without food.

Fatigue. Even a moderate amount of fatigue can reduce mental ability. Fatigue can make people careless as it becomes increasingly easy to adopt the feeling of just not caring. This is one of the biggest dangers in survival. While fatigue can be caused by over-exertion, it may also be caused by hopelessness, losing sight of goals, dissatisfaction, frustration or boredom. Fatigue may represent an escape from a situation that has become too difficult. Recognizing the dangers of a situation can provide the strength to go on. Watch exertion levels, set goals, and stay busy.



Activate Your Brain #1:

What signs of fatigue did the crew of the "Times A Wastin" exhibit?

Even though the crew was suffering from fatigue, why did they spend so much energy to keep the plane cleared of snow?

Boredom and loneliness. Boredom and loneliness represent the final two enemies of survival. They are perhaps two of the toughest enemies of survival, mainly because they are unexpected. When nothing happens, when something is expected and does not happen, or when one must stay still, quiet, and alone, these feelings develop. They can cause discouragement and a lack of will to go on. Invent games, stay active, and create projects.



How did you deal with boredom and loneliness during your survival training? Did it help?

SECTION 3 AIRCREW SURVIVAL

During EO M409.01 (Identify Methods of Instruction) you were shown that a case study requires four lists to be created: **facts**, **assumptions**, **problems**, and **solutions**.



A **fact** is something that is known to have occurred.

An **assumption** is something that a person takes or accepts to be true, without proof, for the purpose of an argument or action.

A **problem** is a doubtful or difficult matter requiring a solution.

A **solution** is an act or means of solving a problem or difficulty.



Activate Your Brain #2:

Based on the case study, create a list of facts, a list of assumptions, a list of problems, and a list of solutions.

The list of problems should be based on the survival pattern and the seven enemies of survival.

The list of solutions should be the ones the aircrew came up with, not what you think they should have done.

Facts

Assumptions

Problems

Solutions

Analyzing the Cause of the Accident

Based on your analysis of the case study, what was the main cause of the accident? Explain your reasoning.

Examining the Survival Situation

Based on your analysis of the case study, what were the main survival concerns? Explain your reasoning.

Investigating the Actions of the Survivor(s)

Based on your analysis of the case study, were the actions of the aircrew appropriate? Explain your reasoning.

Reflecting on the Outcome

Based on your analysis of the case study, what would you have done differently? Explain your reasoning.



Congratulations, you have completed your self-study package on EO C590.01 (Analyze an Aircrew Survival Case Study). Hand the completed package to the Training Officer / Proficiency Level Officer who will record your completion in your Proficiency Level Five logbook.

THIS PAGE INTENTIONALLY LEFT BLANK

ACTIVATE YOUR BRAIN ANSWER KEY



Activate Your Brain #1:

What signs of fatigue did the crew of the "Times A Wastin" exhibit?

accidents (through carelessness)
lack of energy

poor decisions
lack of motivation

Even though the crew was suffering from fatigue, why did they spend so much energy to keep the plane cleared of snow?

So that the plane could be seen from the air and not blend into the landscape.



Activate Your Brain #2:

Based on the case study, create a list of facts, a list of assumptions, a list of problems, and a list of solutions.

The list of problems should be based on the survival pattern and the seven enemies of survival.

The list of solutions should be the ones the aircrew came up with, not what you think they should have done.

Facts

winter
poor weather
above treeline
no injuries due to crash landing
did inventory of food and supplies
scouted immediate area
found lake (water source)
found seals (food source)

Assumptions

navigation error
location of Hebron
lots of food available
could fix putput
safe to use boat
boat trip would take 10 days

Problems

cold / wind
limited supply of fuel for fire
thirst
hunger
pain
signals
fatigue
boredom
loneliness

Solutions

built lean-to with a tarp over wing
used fire only as needed
found water, melted ice / snow
pooled food, caught bird
applied first aid as required
tried to fix radio
reduced physical activity
played cards, did chores
talked to each other



For the following questions the most likely answers are listed. The cadet's explanation of their answer should be well reasoned. Their reasoning may be based on the case study, their training and their personal experiences.

Note: The cadet may think of answers that are not listed. Such answers are acceptable if they are both plausible and well reasoned.

Analyzing the Cause of the Accident

Based on your analysis of the case study, what was the main cause of the accident? Explain your reasoning.

Poor Weather
Navigation Error
Equipment Failure

Examining the Survival Situation

Based on your analysis of the case study, what were the main survival concerns? Explain your reasoning.

Cold
Food
Fatigue
Landing Above the Treeline

Investigating the Actions of the Survivor(s)

Based on your analysis of the case study, were the actions of the aircrew appropriate? Explain your reasoning.

Yes
No

Reflecting on the Outcome

Based on your analysis of the case study, what would you have done differently? Explain your reasoning.

Stayed Together
Walked to Hebron
Searched for More Liquid Water Sources
Hunted / Fished for Food
Created Ground-to-Air Signals